



Bridgelux® Gen 8 Vero® SE 13 Array

Product Data Sheet DS431



Introduction

Vero SE



The Vero® SE Series is a revolutionary light source system that integrates Bridgelux's eighth generation COB technology with poke-in connectivity, enabling solder-free installation. Vero SE LED light sources streamline assembly processes, lower manufacturing costs, simplify the luminaire design process, improve light quality, and increase design flexibility.

Vero SE is available in four different light emitting surface (LES) configurations that operate reliably over a broad current range. With Vero SE, secondary connector and holder components are not required, allowing for rapid integration of arrays into fixtures, and an efficient field replaceable solution. Vero SE arrays deliver increased lumen density for improved beam control and precision lighting, with 2 and 3 SDCM color control standards for clean and consistent uniform lighting.

Features

- Poke-in electrical connectivity
- Top side part number markings
- Efficacy of 175 lm/W typical, 3000K 80 CRI
- Reliable operation at up to 3x nominal current, 30% increase in maximum lumens per LES size
- Wide selection of CCT options (2700K-6500K) with minimum 70, 80 and 90 CRI options
- Uniform high-quality illumination
- 2 and 3 SDCM binning options (2700K – 4000K)
- Forward voltage bin codes (backside marking)
- 10-Year warranty

Benefits

- Low cost, solderless, connector free installation and field upgradability
- Improved inventory management and quality control
- Enables high efficiency lighting systems and lower operating costs
- Supports the trend toward luminaire miniaturization and delivers enhanced optical control
- Design flexibility for a broad range of lighting applications
- Clean white light without pixelation
- Uniform consistent white light
- Design flexibility for multi-source applications
- Design with confidence

Contents

Product Feature Map	2
Product Nomenclature	2
Product Selection Guide	3
Performance at Commonly Used Drive Currents	7
Electrical Characteristics	16
Eye Safety	17
Absolute Maximum Ratings	18
Performance Curves	19
Typical Radiation Pattern	21
Typical Color Spectrum	22
Mechanical Dimensions	23
Color Binning Information	24
Packaging and Labeling	25
Design Resources	27
Precautions	27
Disclaimers	27
About Bridgelux	28

Product Selection Guide

The following product configurations are available:

Table 1: Selection Guide, Pulsed Measurement Data ($T_j = T_c = 25^\circ\text{C}$)

Part Number	Nominal CCT ¹ (K)	CRI ²	Nominal Drive Current ³ (mA)	Typical Pulsed Flux ^{4,5,6} $T_c = 25^\circ\text{C}$ (lm)	Minimum Pulsed Flux ^{6,7} $T_c = 25^\circ\text{C}$ (lm)	Typical V_f (V)	Typical Power (W)	Typical Efficacy (lm/W)
BXRC-27E2000-B-8x-SE	2700	80	350	1924	1732	33.4	11.7	165
BXRC-27E2000-C-8x-SE	2700	80	500	2749	2474	33.4	16.7	165
BXRC-27E2000-D-8x-SE	2700	80	400	2026	1824	30.9	12.4	164
BXRC-27G2000-B-8x-SE	2700	90	350	1587	1429	33.4	11.7	136
BXRC-27G2000-C-8x-SE	2700	90	500	2268	2041	33.4	16.7	136
BXRC-27G2000-D-8x-SE	2700	90	400	1672	1505	30.9	12.4	135
BXRC-27G20Ho-B-8x-SE	2700	90	350	1656	1490	33.4	11.7	142
BXRC-27G20Ho-C-8x-SE	2700	90	500	2366	2129	33.4	16.7	142
BXRC-27G20Ho-D-8x-SE	2700	90	400	1744	1570	30.9	12.4	141
BXRC-30C2001-B-8x-SE	3000	70	350	2140	1926	33.4	11.7	183
BXRC-30C2001-C-8x-SE	3000	70	500	3058	2752	33.4	16.7	183
BXRC-30C2001-D-8x-SE	3000	70	400	2254	2029	30.9	12.4	182
BXRC-30E2000-B-8x-SE	3000	80	350	2044	1840	33.4	11.7	175
BXRC-30E2000-C-8x-SE	3000	80	500	2920	2628	33.4	16.7	175
BXRC-30E2000-D-8x-SE	3000	80	400	2153	1938	30.9	12.4	174
BXRC-30G2000-B-8x-SE	3000	90	350	1659	1494	33.4	11.7	142
BXRC-30G2000-C-8x-SE	3000	90	500	2371	2134	33.4	16.7	142
BXRC-30G2000-D-8x-SE	3000	90	400	1748	1573	30.9	12.4	141
BXRC-30G20Ho-B-8x-SE	3000	90	350	1738	1564	33.4	11.7	149
BXRC-30G20Ho-C-8x-SE	3000	90	500	2482	2234	33.4	16.7	149
BXRC-30G20Ho-D-8x-SE	3000	90	400	1830	1647	30.9	12.4	148
BXRC-35E2000-B-8x-SE	3500	80	350	2092	1883	33.4	11.7	179
BXRC-35E2000-C-8x-SE	3500	80	500	2989	2690	33.4	16.7	179
BXRC-35E2000-D-8x-SE	3500	80	400	2204	1983	30.9	12.4	178
BXRC-35G2000-B-8x-SE	3500	90	350	1720	1548	33.4	11.7	147
BXRC-35G2000-C-8x-SE	3500	90	500	2457	2211	33.4	16.7	147
BXRC-35G2000-D-8x-SE	3500	90	400	1811	1630	30.9	12.4	147
BXRC-40C2001-B-8x-SE	4000	70	350	2201	1981	33.4	11.7	188
BXRC-40C2001-C-8x-SE	4000	70	500	3144	2829	33.4	16.7	188
BXRC-40C2001-D-8x-SE	4000	70	400	2318	2086	30.9	12.4	188
BXRC-40E2000-B-8x-SE	4000	80	350	2104	1894	33.4	11.7	180
BXRC-40E2000-C-8x-SE	4000	80	500	3006	2706	33.4	16.7	180
BXRC-40E2000-D-8x-SE	4000	80	400	2216	1995	30.9	12.4	179

Notes for Table 1:

- Nominal CCT as defined by ANSI C78.377-2011. Products with a CCT of 5000K-6500K are hot targeted to $T_c = 85^\circ\text{C}$.
- CRI values are minimums for all products. Minimum Rg value for 80 CRI products is 0, the minimum Rg value for 90 CRI products is 50, the minimum Rg value for 97 CRI products is 93. Bridgelux maintains a ± 3 tolerance on CRI and Rg values.
- Drive current is referred to as nominal drive current.
- Products tested under pulsed condition (10ms pulse width) at nominal test current where T_j (junction temperature) - T_c (case temperature) = 25°C .
- Typical performance values are provided as a reference only and are not a guarantee of performance.
- Bridgelux maintains a $\pm 7\%$ tolerance on flux measurements.
- Minimum flux values at the nominal test current are guaranteed by 100% test.

Product Selection Guide

Table 1: Selection Guide, Pulsed Measurement Data ($T_j = T_c = 25^\circ\text{C}$) (continued)

Part Number	Nominal CCT ¹ (K)	CRI ²	Nominal Drive Current ³ (mA)	Typical Pulsed Flux ^{4,5,6} $T_c = 25^\circ\text{C}$ (lm)	Minimum Pulsed Flux ^{6,7} $T_c = 25^\circ\text{C}$ (lm)	Typical V_f (V)	Typical Power (W)	Typical Efficacy (lm/W)
BXRC-40G2000-B-8x-SE	4000	90	350	1756	1580	33.4	11.7	150
BXRC-40G2000-C-8x-SE	4000	90	500	2508	2257	33.4	16.7	150
BXRC-40G2000-D-8x-SE	4000	90	400	1849	1664	30.9	12.4	150
BXRC-50C2001-B-8x-SE	5000	70	350	2213	1991	33.4	11.7	189
BXRC-50C2001-C-8x-SE	5000	70	500	3161	2845	33.4	16.7	189
BXRC-50C2001-D-8x-SE	5000	70	400	2330	2097	30.9	12.4	189
BXRC-50E2001-B-8x-SE	5000	80	350	2128	1916	33.4	11.7	182
BXRC-50E2001-C-8x-SE	5000	80	500	3041	2737	33.4	16.7	182
BXRC-50E2001-D-8x-SE	5000	80	400	2242	2018	30.9	12.4	181
BXRC-50G2001-B-8x-SE	5000	90	350	1840	1656	33.4	11.7	157
BXRC-50G2001-C-8x-SE	5000	90	500	2628	2366	33.4	16.7	157
BXRC-50G2001-D-8x-SE	5000	90	400	1938	1744	30.9	12.4	157
BXRC-57C2001-B-8x-SE	5700	70	350	2153	1937	33.4	11.7	184
BXRC-57C2001-C-8x-SE	5700	70	500	3075	2768	33.4	16.7	184
BXRC-57C2001-D-8x-SE	5700	70	400	2267	2040	30.9	12.4	183
BXRC-57E2001-B-8x-SE	5700	80	350	2044	1840	33.4	11.7	175
BXRC-57E2001-C-8x-SE	5700	80	500	2920	2628	33.4	16.7	175
BXRC-57E2001-D-8x-SE	5700	80	400	2153	1938	30.9	12.4	174
BXRC-65C2001-B-8x-SE	6500	70	350	2153	1937	33.4	11.7	184
BXRC-65C2001-C-8x-SE	6500	70	500	3075	2768	33.4	16.7	184
BXRC-65C2001-D-8x-SE	6500	70	400	2267	2040	30.9	12.4	183
BXRC-65E2001-B-8x-SE	6500	80	350	2068	1861	33.4	11.7	177
BXRC-65E2001-C-8x-SE	6500	80	500	2955	2659	33.4	16.7	177
BXRC-65E2001-D-8x-SE	6500	80	400	2178	1961	30.9	12.4	176

Notes for Table 1:

- Nominal CCT as defined by ANSI C78.377-2011. Products with a CCT of 5000K-6500K are hot targeted to $T_c = 85^\circ\text{C}$.
- CRI values are minimums for all products. Minimum Rg value for 80 CRI products is 0, the minimum Rg value for 90 CRI products is 50. Bridgelux maintains a ± 3 tolerance on CRI and Rg values.
- Drive current is referred to as nominal drive current.
- Products tested under pulsed condition (10ms pulse width) at nominal test current where T_j (junction temperature) - T_c (case temperature) = 25°C .
- Typical performance values are provided as a reference only and are not a guarantee of performance.
- Bridgelux maintains a $\pm 7\%$ tolerance on flux measurements.
- Minimum flux values at the nominal test current are guaranteed by 100% test.

Product Selection Guide

Table 2: Selection Guide, Stabilized DC Performance ($T_c = 85^\circ\text{C}$)^{4,5}

Part Number	Nominal CCT ¹ (K)	CRI ²	Nominal Drive Current ³ (mA)	Typical DC Flux ^{4,5} $T_c = 85^\circ\text{C}$ (lm)	Minimum DC Flux ⁶ $T_c = 85^\circ\text{C}$ (lm)	Typical V_f (V)	Typical Power (W)	Typical Efficacy (lm/W)
BXRC-27E2000-B-8x-SE	2700	80	350	1732	1558	32.7	11.4	151
BXRC-27E2000-C-8x-SE	2700	80	500	2474	2226	32.7	16.3	151
BXRC-27E2000-D-8x-SE	2700	80	400	1824	1641	30.2	12.1	151
BXRC-27G2000-B-8x-SE	2700	90	350	1429	1286	32.7	11.4	125
BXRC-27G2000-C-8x-SE	2700	90	500	2041	1837	32.7	16.3	125
BXRC-27G2000-D-8x-SE	2700	90	400	1505	1354	30.2	12.1	124
BXRC-27G20H0-B-8x-SE	2700	90	350	1490	1341	32.7	11.4	130
BXRC-27G20H0-C-8x-SE	2700	90	500	2129	1916	32.7	16.3	130
BXRC-27G20H0-D-8x-SE	2700	90	400	1570	1413	30.2	12.1	130
BXRC-30C2001-B-8x-SE	3000	70	350	1926	1734	32.7	11.4	168
BXRC-30C2001-C-8x-SE	3000	70	500	2752	2477	32.7	16.3	168
BXRC-30C2001-D-8x-SE	3000	70	400	2029	1826	30.2	12.1	168
BXRC-30E2000-B-8x-SE	3000	80	350	1840	1656	32.7	11.4	161
BXRC-30E2000-C-8x-SE	3000	80	500	2628	2366	32.7	16.3	161
BXRC-30E2000-D-8x-SE	3000	80	400	1938	1744	30.2	12.1	160
BXRC-30G2000-B-8x-SE	3000	90	350	1494	1344	32.7	11.4	131
BXRC-30G2000-C-8x-SE	3000	90	500	2134	1920	32.7	16.3	131
BXRC-30G2000-D-8x-SE	3000	90	400	1573	1416	30.2	12.1	130
BXRC-30G20H0-B-8x-SE	3000	90	350	1564	1407	32.7	11.4	137
BXRC-30G20H0-C-8x-SE	3000	90	500	2234	2011	32.7	16.3	137
BXRC-30G20H0-D-8x-SE	3000	90	400	1647	1482	30.2	12.1	136
BXRC-35E2000-B-8x-SE	3500	80	350	1883	1695	32.7	11.4	165
BXRC-35E2000-C-8x-SE	3500	80	500	2690	2421	32.7	16.3	165
BXRC-35E2000-D-8x-SE	3500	80	400	1983	1785	30.2	12.1	164
BXRC-35G2000-B-8x-SE	3500	90	350	1548	1393	32.7	11.4	135
BXRC-35G2000-C-8x-SE	3500	90	500	2211	1990	32.7	16.3	135
BXRC-35G2000-D-8x-SE	3500	90	400	1630	1467	30.2	12.1	135
BXRC-40C2001-B-8x-SE	4000	70	350	1981	1782	32.7	11.4	173
BXRC-40C2001-C-8x-SE	4000	70	500	2829	2546	32.7	16.3	173
BXRC-40C2001-D-8x-SE	4000	70	400	2086	1877	30.2	12.1	173
BXRC-40E2000-B-8x-SE	4000	80	350	1894	1705	32.7	11.4	166
BXRC-40E2000-C-8x-SE	4000	80	500	2706	2435	32.7	16.3	166
BXRC-40E2000-D-8x-SE	4000	80	400	1995	1795	30.2	12.1	165
BXRC-40G2000-B-8x-SE	4000	90	350	1580	1422	32.7	11.4	138
BXRC-40G2000-C-8x-SE	4000	90	500	2257	2032	32.7	16.3	138
BXRC-40G2000-D-8x-SE	4000	90	400	1664	1498	30.2	12.1	138

Notes for Table 2:

- Nominal CCT as defined by ANSI C78.377-2011. Products with a CCT of 5000K-6500K are hot targeted to $T_c = 85^\circ\text{C}$.
- CRI values are minimums for all other products. Minimum Rg value for 80 CRI products is 0, the minimum Rg value for 90 CRI products is 50. Bridgelux maintains a ± 3 tolerance on CRI and Rg values.
- Drive current is referred to as nominal drive current.
- Typical stabilized DC performance values are provided as reference only and are not a guarantee of performance.
- Typical performance is estimated based on operation under DC (direct current) with LED array mounted onto a heat sink with thermal interface material and the case temperature maintained at 85°C . Based on Bridgelux test setup, values may vary depending on the thermal design of the luminaire and/or the exposed environment to which the product is subjected.
- Minimum flux values at elevated temperatures are provided for reference only and are not guaranteed by 100% production testing. Based on Bridgelux test setup, values may vary depending on the thermal design of the luminaire and/or the exposed environment to which the product is subjected.

Product Selection Guide

Table 2: Selection Guide, Stabilized DC Performance ($T_c = 85^\circ\text{C}$)^{4,5} (continued)

Part Number	Nominal CCT ¹ (K)	CRI ²	Nominal Drive Current ³ (mA)	Typical DC Flux ^{4,5} $T_c = 85^\circ\text{C}$ (lm)	Minimum DC Flux ⁶ $T_c = 85^\circ\text{C}$ (lm)	Typical V_f (V)	Typical Power (W)	Typical Efficacy (lm/W)
BXRC-50C2001-B-8x-SE	5000	70	350	1991	1792	32.7	11.4	174
BXRC-50C2001-C-8x-SE	5000	70	500	2845	2560	32.7	16.3	174
BXRC-50C2001-D-8x-SE	5000	70	400	2097	1888	30.2	12.1	173
BXRC-50E2001-B-8x-SE	5000	80	350	1916	1724	32.7	11.4	167
BXRC-50E2001-C-8x-SE	5000	80	500	2737	2463	32.7	16.3	167
BXRC-50E2001-D-8x-SE	5000	80	400	2018	1816	30.2	12.1	167
BXRC-50G2001-B-8x-SE	5000	90	350	1656	1490	32.7	11.4	145
BXRC-50G2001-C-8x-SE	5000	90	500	2366	2129	32.7	16.3	145
BXRC-50G2001-D-8x-SE	5000	90	400	1744	1570	30.2	12.1	144
BXRC-57C2001-B-8x-SE	5700	70	350	1937	1744	32.7	11.4	169
BXRC-57C2001-C-8x-SE	5700	70	500	2768	2491	32.7	16.3	169
BXRC-57C2001-D-8x-SE	5700	70	400	2040	1836	30.2	12.1	169
BXRC-57E2001-B-8x-SE	5700	80	350	1840	1656	32.7	11.4	161
BXRC-57E2001-C-8x-SE	5700	80	500	2628	2366	32.7	16.3	161
BXRC-57E2001-D-8x-SE	5700	80	400	1938	1744	30.2	12.1	160
BXRC-65C2001-B-8x-SE	6500	70	350	1937	1744	32.7	11.4	169
BXRC-65C2001-C-8x-SE	6500	70	500	2768	2491	32.7	16.3	169
BXRC-65C2001-D-8x-SE	6500	70	400	2040	1836	30.2	12.1	169
BXRC-65E2001-B-8x-SE	6500	80	350	1861	1675	32.7	11.4	163
BXRC-65E2001-C-8x-SE	6500	80	500	2659	2393	32.7	16.3	163
BXRC-65E2001-D-8x-SE	6500	80	400	1961	1764	30.2	12.1	162

Notes for Table 2:

- Nominal CCT as defined by ANSI C78.377-2011. Products with a CCT of 5000K-6500K are not targeted to $T_c = 85^\circ\text{C}$.
- CRI values are minimums for all other products. Minimum Rg value for 80 CRI products is 0, the minimum Rg value for 90 CRI products is 50. Bridgelux maintains a ± 3 tolerance on CRI and Rg values.
- Drive current is referred to as nominal drive current.
- Typical stabilized DC performance values are provided as reference only and are not a guarantee of performance.
- Typical performance is estimated based on operation under DC (direct current) with LED array mounted onto a heat sink with thermal interface material and the case temperature maintained at 85°C . Based on Bridgelux test setup, values may vary depending on the thermal design of the luminaire and/or the exposed environment to which the product is subjected.
- Minimum flux values at elevated temperatures are provided for reference only and are not guaranteed by 100% production testing. Based on Bridgelux test setup, values may vary depending on the thermal design of the luminaire and/or the exposed environment to which the product is subjected.

Performance at Commonly Used Drive Currents

Vero LED arrays are tested to the specifications shown using the nominal drive currents in Table 1. Vero SE may also be driven at other drive currents dependent on specific application design requirements. The performance at any drive current can be derived from the current vs. voltage characteristics shown in Figures 1, 2 & 3 and the flux vs. current characteristics shown in Figures 4, 5 & 6. The performance at commonly used drive currents is summarized in Table 3.

Table 3: Product Performance at Commonly Used Drive Currents

Part Number	CRI	Drive Current ¹ (mA)	Typical V _f T _c = 25°C (V)	Typical Power T _c = 25°C (W)	Typical Flux ² T _c = 25°C (lm)	Typical DC Flux ³ T _c = 85°C (lm)	Typical Efficacy T _c = 25°C (lm/W)
BXRC-27E2000-B-8x-SE	80	175	32.4	5.7	998	898	176
		260	32.9	8.6	1447	1302	169
		350	33.4	11.7	1924	1732	165
		450	33.9	15.3	2429	2186	159
		700	35.2	24.6	3675	3307	149
		1250	37.6	47.0	6236	5612	133
BXRC-27E2000-C-8x-SE	80	250	32.5	8.1	1426	1283	176
		375	33.0	12.4	2086	1877	169
		500	33.4	16.7	2749	2474	164
		630	33.9	21.4	3404	3064	159
		1000	35.2	35.2	5250	4725	149
		1750	37.5	65.7	8750	7875	133
BXRC-27E2000-D-8x-SE	80	200	30.0	6.0	1051	946	175
		300	30.4	9.1	1538	1384	169
		400	30.9	12.3	2026	1824	164
		500	31.3	15.6	2491	2242	159
		800	32.5	26.0	3871	3483	149
		1250	34.1	42.7	5828	5245	137
BXRC-27G2000-B-8x-SE	90	175	32.4	5.7	823	741	145
		260	32.9	8.6	1194	1074	140
		350	33.4	11.7	1587	1429	136
		450	33.9	15.3	2004	1803	131
		700	35.2	24.6	3032	2729	123
		1250	37.6	47.0	5145	4630	109
BXRC-27G2000-C-8x-SE	90	250	32.5	8.1	1176	1059	145
		375	33.0	12.4	1721	1549	139
		500	33.4	16.7	2268	2041	136
		630	33.9	21.4	2808	2527	131
		1000	35.2	35.2	4331	3898	123
		1750	37.5	65.7	7219	6497	110
BXRC-27G2000-D-8x-SE	90	200	30.0	6.0	867	781	145
		300	30.4	9.1	1269	1142	139
		400	30.9	12.3	1672	1505	135
		500	31.3	15.6	2055	1849	131
		800	32.5	26.0	3193	2874	123
		1250	34.1	42.7	4808	4327	113

Notes for Table 3:

1. Alternate drive currents in Table 3 are provided for reference only and are not a guarantee of performance.
2. Bridgelux maintains a ± 7% tolerance on flux measurements.
3. Typical stabilized DC performance values are provided as reference only and are not a guarantee of performance.

Performance at Commonly Used Drive Currents

Table 3: Product Performance at Commonly Used Drive Currents (Continued)

Part Number	CRI	Drive Current ¹ (mA)	Typical V _f T _c = 25°C (V)	Typical Power T _c = 25°C (W)	Typical Flux ² T _c = 25°C (lm)	Typical DC Flux ³ T _c = 85°C (lm)	Typical Efficacy T _c = 25°C (lm/W)
BXRC-27G20H0-B-8x-SE	90	175	32.4	5.7	859	773	151
		260	32.9	8.6	1245	1121	146
		350	33.4	11.7	1656	1490	142
		450	33.9	15.3	2090	1881	137
		700	35.2	24.6	3163	2847	128
		1250	37.6	47.0	5367	4830	114
BXRC-27G20H0-C-8x-SE	90	250	32.5	8.1	1227	1104	151
		375	33.0	12.4	1795	1616	145
		500	33.4	16.7	2366	2129	142
		630	33.9	21.4	2930	2637	137
		1000	35.2	35.2	4518	4066	128
		1750	37.5	65.7	7530	6777	115
BXRC-27G20H0-D-8x-SE	90	200	30.0	6.0	905	814	151
		300	30.4	9.1	1323	1191	145
		400	30.9	12.3	1744	1570	141
		500	31.3	15.6	2144	1929	137
		800	32.5	26.0	3331	2998	128
		1250	34.1	42.7	5016	4514	118
BXRC-30C2001-B-8x-SE	70	175	32.4	5.7	1110	999	196
		260	32.9	8.6	1610	1449	188
		350	33.4	11.7	2140	1926	183
		450	33.9	15.3	2702	2432	177
		700	35.2	24.6	4088	3680	166
		1250	37.6	47.0	6937	6244	148
BXRC-30C2001-C-8x-SE	70	250	32.5	8.1	1586	1428	195
		375	33.0	12.4	2320	2088	188
		500	33.4	16.7	3058	2752	183
		630	33.9	21.4	3787	3408	177
		1000	35.2	35.2	5841	5257	166
		1750	37.5	65.7	9734	8761	148
BXRC-30C2001-D-8x-SE	70	200	30.0	6.0	1170	1053	195
		300	30.4	9.1	1711	1540	187
		400	30.9	12.3	2254	2029	183
		500	31.3	15.6	2771	2494	177
		800	32.5	26.0	4306	3875	166
		1250	34.1	42.7	6484	5835	152
BXRC-30E2000-B-8x-SE	80	175	32.4	5.7	1061	954	187
		260	32.9	8.6	1537	1384	180
		350	33.4	11.7	2044	1840	175
		450	33.9	15.3	2580	2322	169
		700	35.2	24.6	3905	3514	159
		1250	37.6	47.0	6626	5963	141

Notes for Table 3:

1. Alternate drive currents in Table 3 are provided for reference only and are not a guarantee of performance.
2. Bridgelux maintains a ± 7% tolerance on flux measurements.
3. Typical stabilized DC performance values are provided as reference only and are not a guarantee of performance.

Performance at Commonly Used Drive Currents

Table 3: Product Performance at Commonly Used Drive Currents (Continued)

Part Number	CRI	Drive Current ¹ (mA)	Typical V _f T _c = 25°C (V)	Typical Power T _c = 25°C (W)	Typical Flux ² T _c = 25°C (lm)	Typical DC Flux ³ T _c = 85°C (lm)	Typical Efficacy T _c = 25°C (lm/W)
BXRC-30E2000-C-8x-SE	80	250	32.5	8.1	1515	1364	187
		375	33.0	12.4	2216	1995	179
		500	33.4	16.7	2920	2628	175
		630	33.9	21.4	3617	3255	169
		1000	35.2	35.2	5578	5020	158
		1750	37.5	65.7	9297	8367	142
BXRC-30E2000-D-8x-SE	80	200	30.0	6.0	1117	1005	186
		300	30.4	9.1	1634	1470	179
		400	30.9	12.3	2153	1938	174
		500	31.3	15.6	2646	2382	169
		800	32.5	26.0	4112	3701	158
		1250	34.1	42.7	6192	5573	145
BXRC-30G2000-B-8x-SE	90	175	32.4	5.7	861	775	152
		260	32.9	8.6	1248	1123	146
		350	33.4	11.7	1659	1494	142
		450	33.9	15.3	2095	1885	137
		700	35.2	24.6	3170	2853	129
		1250	37.6	47.0	5378	4841	114
BXRC-30G2000-C-8x-SE	90	250	32.5	8.1	1230	1107	151
		375	33.0	12.4	1799	1619	146
		500	33.4	16.7	2371	2134	142
		630	33.9	21.4	2936	2642	137
		1000	35.2	35.2	4528	4075	129
		1750	37.5	65.7	7547	6792	115
BXRC-30G2000-D-8x-SE	90	200	30.0	6.0	907	816	151
		300	30.4	9.1	1326	1194	145
		400	30.9	12.3	1748	1573	142
		500	31.3	15.6	2148	1933	137
		800	32.5	26.0	3338	3005	128
		1250	34.1	42.7	5027	4524	118
BXRC-30G20H0-B-8x-SE	90	175	32.4	5.7	901	811	159
		260	32.9	8.6	1307	1176	153
		350	33.4	11.7	1738	1564	149
		450	33.9	15.3	2193	1974	144
		700	35.2	24.6	3319	2987	135
		1250	37.6	47.0	5632	5069	120
BXRC-30G20H0-C-8x-SE	90	250	32.5	8.1	1288	1159	159
		375	33.0	12.4	1884	1695	152
		500	33.4	16.7	2482	2234	148
		630	33.9	21.4	3074	2767	144
		1000	35.2	35.2	4741	4267	135
		1750	37.5	65.7	7902	7112	120

Notes for Table 3:

1. Alternate drive currents in Table 3 are provided for reference only and are not a guarantee of performance.
2. Bridgelux maintains a ± 7% tolerance on flux measurements.
3. Typical stabilized DC performance values are provided as reference only and are not a guarantee of performance.

Performance at Commonly Used Drive Currents

Table 3: Product Performance at Commonly Used Drive Currents (Continued)

Part Number	CRI	Drive Current ¹ (mA)	Typical V_f $T_c = 25^\circ\text{C}$ (V)	Typical Power $T_c = 25^\circ\text{C}$ (W)	Typical Flux ² $T_c = 25^\circ\text{C}$ (lm)	Typical DC Flux ³ $T_c = 85^\circ\text{C}$ (lm)	Typical Efficacy $T_c = 25^\circ\text{C}$ (lm/W)
BXRC-30G20H0-D-8x-SE	90	200	30.0	6.0	949	854	158
		300	30.4	9.1	1389	1250	152
		400	30.9	12.3	1830	1647	148
		500	31.3	15.6	2249	2025	144
		800	32.5	26.0	3496	3146	134
		1250	34.1	42.7	5263	4737	123
BXRC-35E2000-B-8x-SE	80	175	32.4	5.7	1086	977	191
		260	32.9	8.6	1574	1416	184
		350	33.4	11.7	2092	1883	179
		450	33.9	15.3	2641	2377	173
		700	35.2	24.6	3997	3597	162
		1250	37.6	47.0	6781	6103	144
BXRC-35E2000-C-8x-SE	80	250	32.5	8.1	1551	1396	191
		375	33.0	12.4	2268	2041	184
		500	33.4	16.7	2989	2690	179
		630	33.9	21.4	3702	3332	173
		1000	35.2	35.2	5709	5138	162
		1750	37.5	65.7	9515	8564	145
BXRC-35E2000-D-8x-SE	80	200	30.0	6.0	1143	1029	191
		300	30.4	9.1	1672	1505	183
		400	30.9	12.3	2204	1983	179
		500	31.3	15.6	2709	2438	173
		800	32.5	26.0	4209	3788	162
		1250	34.1	42.7	6338	5704	149
BXRC-35G2000-B-8x-SE	90	175	32.4	5.7	892	803	157
		260	32.9	8.6	1293	1164	151
		350	33.4	11.7	1720	1548	147
		450	33.9	15.3	2171	1954	142
		700	35.2	24.6	3285	2956	133
		1250	37.6	47.0	5573	5016	119
BXRC-35G2000-C-8x-SE	90	250	32.5	8.1	1274	1147	157
		375	33.0	12.4	1864	1678	151
		500	33.4	16.7	2457	2211	147
		630	33.9	21.4	3042	2738	142
		1000	35.2	35.2	4692	4223	133
		1750	37.5	65.7	7820	7038	119
BXRC-35G2000-D-8x-SE	90	200	30.0	6.0	940	846	157
		300	30.4	9.1	1374	1237	151
		400	30.9	12.3	1811	1630	147
		500	31.3	15.6	2226	2004	142
		800	32.5	26.0	3459	3113	133
		1250	34.1	42.7	5209	4688	122

Notes for Table 3:

1. Alternate drive currents in Table 3 are provided for reference only and are not a guarantee of performance.
2. Bridgelux maintains a $\pm 7\%$ tolerance on flux measurements.
3. Typical stabilized DC performance values are provided as reference only and are not a guarantee of performance.

Performance at Commonly Used Drive Currents

Table 3: Product Performance at Commonly Used Drive Currents (Continued)

Part Number	CRI	Drive Current ¹ (mA)	Typical V _f T _c = 25°C (V)	Typical Power T _c = 25°C (W)	Typical Flux ² T _c = 25°C (lm)	Typical DC Flux ³ T _c = 85°C (lm)	Typical Efficacy T _c = 25°C (lm/W)
BXRC-40C2001-B-8x-SE	70	175	32.4	5.7	1142	1027	201
		260	32.9	8.6	1655	1489	193
		350	33.4	11.7	2201	1981	188
		450	33.9	15.3	2778	2500	182
		700	35.2	24.6	4203	3783	171
		1250	37.6	47.0	7132	6419	152
BXRC-40C2001-C-8x-SE	70	250	32.5	8.1	1631	1468	201
		375	33.0	12.4	2386	2147	193
		500	33.4	16.7	3144	2829	188
		630	33.9	21.4	3893	3504	182
		1000	35.2	35.2	6005	5404	171
		1750	37.5	65.7	10008	9007	152
BXRC-40C2001-D-8x-SE	70	200	30.0	6.0	1202	1082	201
		300	30.4	9.1	1759	1583	193
		400	30.9	12.3	2318	2086	188
		500	31.3	15.6	2849	2564	182
		800	32.5	26.0	4427	3984	170
		1250	34.1	42.7	6666	5999	156
BXRC-40E2000-B-8x-SE	80	175	32.4	5.7	1092	983	192
		260	32.9	8.6	1583	1424	185
		350	33.4	11.7	2104	1894	180
		450	33.9	15.3	2656	2391	174
		700	35.2	24.6	4020	3618	163
		1250	37.6	47.0	6820	6138	145
BXRC-40E2000-C-8x-SE	80	250	32.5	8.1	1560	1404	192
		375	33.0	12.4	2281	2053	185
		500	33.4	16.7	3006	2706	180
		630	33.9	21.4	3723	3351	174
		1000	35.2	35.2	5742	5168	163
		1750	37.5	65.7	9570	8613	146
BXRC-40E2000-D-8x-SE	80	200	30.0	6.0	1150	1035	192
		300	30.4	9.1	1682	1514	184
		400	30.9	12.3	2216	1995	180
		500	31.3	15.6	2724	2452	174
		800	32.5	26.0	4233	3810	163
		1250	34.1	42.7	6374	5737	149
BXRC-40G2000-B-8x-SE	90	175	32.4	5.7	911	820	160
		260	32.9	8.6	1320	1188	154
		350	33.4	11.7	1756	1580	150
		450	33.9	15.3	2216	1994	145
		700	35.2	24.6	3353	3018	136
		1250	37.6	47.0	5690	5121	121

Notes for Table 3:

1. Alternate drive currents in Table 3 are provided for reference only and are not a guarantee of performance.
2. Bridgelux maintains a ± 7% tolerance on flux measurements.
3. Typical stabilized DC performance values are provided as reference only and are not a guarantee of performance.

Performance at Commonly Used Drive Currents

Table 3: Product Performance at Commonly Used Drive Currents (Continued)

Part Number	CRI	Drive Current ¹ (mA)	Typical V _f T _c = 25°C (V)	Typical Power T _c = 25°C (W)	Typical Flux ² T _c = 25°C (lm)	Typical DC Flux ³ T _c = 85°C (lm)	Typical Efficacy T _c = 25°C (lm/W)
BXRC-40G2000-C-8x-SE	90	250	32.5	8.1	1301	1171	160
		375	33.0	12.4	1903	1713	154
		500	33.4	16.7	2508	2257	150
		630	33.9	21.4	3106	2796	145
		1000	35.2	35.2	4791	4312	136
		1750	37.5	65.7	7984	7186	122
BXRC-40G2000-D-8x-SE	90	200	30.0	6.0	959	863	160
		300	30.4	9.1	1403	1263	154
		400	30.9	12.3	1849	1664	150
		500	31.3	15.6	2273	2046	145
		800	32.5	26.0	3532	3179	136
		1250	34.1	42.7	5318	4786	125
BXRC-50C2001-B-8x-SE	70	175	32.4	5.7	1148	1033	202
		260	32.9	8.6	1664	1498	194
		350	33.4	11.7	2213	1991	189
		450	33.9	15.3	2793	2514	183
		700	35.2	24.6	4226	3804	172
		1250	37.6	47.0	7171	6454	153
BXRC-50C2001-C-8x-SE	70	250	32.5	8.1	1640	1476	202
		375	33.0	12.4	2399	2159	194
		500	33.4	16.7	3161	2845	189
		630	33.9	21.4	3915	3523	183
		1000	35.2	35.2	6037	5434	171
		1750	37.5	65.7	10062	9056	153
BXRC-50C2001-D-8x-SE	70	200	30.0	6.0	1209	1088	202
		300	30.4	9.1	1768	1592	194
		400	30.9	12.3	2330	2097	189
		500	31.3	15.6	2864	2578	183
		800	32.5	26.0	4451	4006	171
		1250	34.1	42.7	6702	6032	157
BXRC-50E2001-B-8x-SE	80	175	32.4	5.7	1104	994	195
		260	32.9	8.6	1601	1441	187
		350	33.4	11.7	2128	1916	182
		450	33.9	15.3	2687	2418	176
		700	35.2	24.6	4065	3659	165
		1250	37.6	47.0	6898	6209	147
BXRC-50E2001-C-8x-SE	80	250	32.5	8.1	1577	1420	194
		375	33.0	12.4	2307	2077	187
		500	33.4	16.7	3041	2737	182
		630	33.9	21.4	3766	3389	176
		1000	35.2	35.2	5808	5227	165
		1750	37.5	65.7	9679	8711	147

Notes for Table 3:

1. Alternate drive currents in Table 3 are provided for reference only and are not a guarantee of performance.
2. Bridgelux maintains a ± 7% tolerance on flux measurements.
3. Typical stabilized DC performance values are provided as reference only and are not a guarantee of performance.

Performance at Commonly Used Drive Currents

Table 3: Product Performance at Commonly Used Drive Currents (Continued)

Part Number	CRI	Drive Current ¹ (mA)	Typical V _f T _c = 25°C (V)	Typical Power T _c = 25°C (W)	Typical Flux ² T _c = 25°C (lm)	Typical DC Flux ³ T _c = 85°C (lm)	Typical Efficacy T _c = 25°C (lm/W)
BXRC-50E2001-D-8x-SE	80	200	30.0	6.0	1163	1047	194
		300	30.4	9.1	1701	1531	186
		400	30.9	12.3	2242	2018	182
		500	31.3	15.6	2755	2480	176
		800	32.5	26.0	4282	3854	165
		1250	34.1	42.7	6447	5803	151
BXRC-50G2001-B-8x-SE	90	175	32.4	5.7	954	859	168
		260	32.9	8.6	1384	1245	162
		350	33.4	11.7	1840	1656	157
		450	33.9	15.3	2322	2090	152
		700	35.2	24.6	3514	3163	143
		1250	37.6	47.0	5963	5367	127
BXRC-50G2001-C-8x-SE	90	250	32.5	8.1	1364	1227	168
		375	33.0	12.4	1995	1795	161
		500	33.4	16.7	2628	2366	157
		630	33.9	21.4	3255	2930	152
		1000	35.2	35.2	5020	4518	143
		1750	37.5	65.7	8367	7530	127
BXRC-50G2001-D-8x-SE	90	200	30.0	6.0	1005	905	168
		300	30.4	9.1	1470	1323	161
		400	30.9	12.3	1938	1744	157
		500	31.3	15.6	2382	2144	152
		800	32.5	26.0	3701	3331	142
		1250	34.1	42.7	5573	5016	131
BXRC-57C2001-B-8x-SE	70	175	32.4	5.7	1117	1005	197
		260	32.9	8.6	1619	1457	189
		350	33.4	11.7	2153	1937	184
		450	33.9	15.3	2717	2445	178
		700	35.2	24.6	4111	3700	167
		1250	37.6	47.0	6976	6279	148
BXRC-57C2001-C-8x-SE	70	250	32.5	8.1	1595	1436	196
		375	33.0	12.4	2333	2100	189
		500	33.4	16.7	3075	2768	184
		630	33.9	21.4	3808	3427	178
		1000	35.2	35.2	5873	5286	167
		1750	37.5	65.7	9789	8810	149
BXRC-57C2001-D-8x-SE	70	200	30.0	6.0	1176	1059	196
		300	30.4	9.1	1720	1548	189
		400	30.9	12.3	2267	2040	184
		500	31.3	15.6	2787	2508	178
		800	32.5	26.0	4330	3897	167
		1250	34.1	42.7	6520	5868	153

Notes for Table 3:

1. Alternate drive currents in Table 3 are provided for reference only and are not a guarantee of performance.
2. Bridgelux maintains a ± 7% tolerance on flux measurements.
3. Typical stabilized DC performance values are provided as reference only and are not a guarantee of performance.

Performance at Commonly Used Drive Currents

Table 3: Product Performance at Commonly Used Drive Currents (Continued)

Part Number	CRI	Drive Current ¹ (mA)	Typical V _f T _c = 25°C (V)	Typical Power T _c = 25°C (W)	Typical Flux ² T _c = 25°C (lm)	Typical DC Flux ³ T _c = 85°C (lm)	Typical Efficacy T _c = 25°C (lm/W)
BXRC-57E2001-B-8x-SE	80	175	32.4	5.7	1061	954	187
		260	32.9	8.6	1537	1384	180
		350	33.4	11.7	2044	1840	175
		450	33.9	15.3	2580	2322	169
		700	35.2	24.6	3905	3514	159
		1250	37.6	47.0	6626	5963	141
BXRC-57E2001-C-8x-SE	80	250	32.5	8.1	1515	1364	187
		375	33.0	12.4	2216	1995	179
		500	33.4	16.7	2920	2628	175
		630	33.9	21.4	3617	3255	169
		1000	35.2	35.2	5578	5020	158
		1750	37.5	65.7	9297	8367	142
BXRC-57E2001-D-8x-SE	80	200	30.0	6.0	1117	1005	186
		300	30.4	9.1	1634	1470	179
		400	30.9	12.3	2153	1938	174
		500	31.3	15.6	2646	2382	169
		800	32.5	26.0	4112	3701	158
		1250	34.1	42.7	6192	5573	145
BXRC-65C2001-B-8x-SE	70	175	32.4	5.7	1117	1005	197
		260	32.9	8.6	1619	1457	189
		350	33.4	11.7	2153	1937	184
		450	33.9	15.3	2717	2445	178
		700	35.2	24.6	4111	3700	167
		1250	37.6	47.0	6976	6279	148
BXRC-65C2001-C-8x-SE	70	250	32.5	8.1	1595	1436	196
		375	33.0	12.4	2333	2100	189
		500	33.4	16.7	3075	2768	184
		630	33.9	21.4	3808	3427	178
		1000	35.2	35.2	5873	5286	167
		1750	37.5	65.7	9789	8810	149
BXRC-65C2001-D-8x-SE	70	200	30.0	6.0	1176	1059	196
		300	30.4	9.1	1720	1548	189
		400	30.9	12.3	2267	2040	184
		500	31.3	15.6	2787	2508	178
		800	32.5	26.0	4330	3897	167
		1250	34.1	42.7	6520	5868	153
BXRC-65E2001-B-8x-SE	80	175	32.4	5.7	1073	966	189
		260	32.9	8.6	1555	1400	182
		350	33.4	11.7	2068	1861	177
		450	33.9	15.3	2611	2350	171
		700	35.2	24.6	3951	3556	160
		1250	37.6	47.0	6704	6033	143

Notes for Table 3:

1. Alternate drive currents in Table 3 are provided for reference only and are not a guarantee of performance.
2. Bridgelux maintains a ± 7% tolerance on flux measurements.
3. Typical stabilized DC performance values are provided as reference only and are not a guarantee of performance.

Performance at Commonly Used Drive Currents

Table 3: Product Performance at Commonly Used Drive Currents (Continued)

Part Number	CRI	Drive Current ¹ (mA)	Typical V _f T _c = 25°C (V)	Typical Power T _c = 25°C (W)	Typical Flux ² T _c = 25°C (lm)	Typical DC Flux ³ T _c = 85°C (lm)	Typical Efficacy T _c = 25°C (lm/W)
BXRC-65E2001-C-8x-SE	80	250	32.5	8.1	1533	1380	189
		375	33.0	12.4	2242	2018	181
		500	33.4	16.7	2955	2659	177
		630	33.9	21.4	3659	3293	171
		1000	35.2	35.2	5644	5079	160
		1750	37.5	65.7	9406	8465	143
BXRC-65E2001-D-8x-SE	80	200	30.0	6.0	1130	1017	189
		300	30.4	9.1	1653	1488	181
		400	30.9	12.3	2178	1961	177
		500	31.3	15.6	2678	2410	171
		800	32.5	26.0	4161	3745	160
		1250	34.1	42.7	6265	5639	147

Notes for Table 3:

1. Alternate drive currents in Table 3 are provided for reference only and are not a guarantee of performance.
2. Bridgelux maintains a ± 7% tolerance on flux measurements.
3. Typical stabilized DC performance values are provided as reference only and are not a guarantee of performance.

Electrical Characteristics

Table 4: Electrical Characteristics

Part Number	Drive Current (mA)	Forward Voltage Pulsed, $T_c = 25^\circ\text{C}$ (V) ^{1, 2, 3, 8}			Typical Coefficient of Forward Voltage ⁴ $\Delta V_f / \Delta T_c$ (mV/ $^\circ\text{C}$)	Typical Thermal Resistance Junction to Case ^{5,6} R_{j-c} ($^\circ\text{C}/\text{W}$)	Driver Selection Voltages ⁷ (V)	
		Minimum	Typical	Maximum			V_f Min. Hot $T_c = 105^\circ\text{C}$ (V)	V_f Max. Cold $T_c = -40^\circ\text{C}$ (V)
BXRC-xxx200x-B-8x-SE	350	30.9	33.4	35.9	-10.77	0.22	30.0	36.6
	1250	34.8	37.6	40.4	-12.13	0.34	33.8	41.2
BXRC-xxx200x-C-8x-SE	500	30.9	33.4	35.9	-10.77	0.19	30.0	36.6
	1750	34.7	37.5	40.3	-12.10	0.29	33.7	41.1
BXRC-xxx200x-D-8x-SE	400	28.6	30.9	33.2	-9.97	0.25	27.8	33.9
	1250	31.5	34.1	36.7	-11.00	0.38	30.7	37.4

Notes for Table 4:

- Parts are tested in pulsed conditions, $T_c = 25^\circ\text{C}$. Pulse width is 10ms.
- Voltage minimum and maximum are provided for reference only and are not a guarantee of performance.
- Bridgelux maintains a tester tolerance of $\pm 0.10\text{V}$ on forward voltage measurements.
- Typical coefficient of forward voltage tolerance is $\pm 0.1\text{mV}$ for nominal current.
- Thermal resistance values are based from test data of a 3000K 80 CRI product.
- Thermal resistance value was calculated using total electrical input power; optical power was not subtracted from input power. The thermal interface material used during testing is not included in the thermal resistance value.
- V_f min hot and max cold values are provided as reference only and are not guaranteed by test. These values are provided to aid in driver design and selection over the operating range of the product.
- This product has been designed and manufactured per IEC 62031:2014. This product has passed dielectric withstand voltage testing at 1140 V. The working voltage designated for the insulation is 70V d.c. The maximum allowable voltage across the array must be determined in the end product application.

Eye Safety

Table 5: Eye Safety Risk Group (RG) Classifications

Part Number	Drive Current (mA)	CCT			
		2700K/3000K	4000K ²	5000K ³	6500K ⁴
BXRC-xxx200x-B-8x-SE	800	RG1	RG1	RG1	RG1
	1110	RG1	RG1	RG1	RG2
	1250	RG1	RG1	RG2	RG2
BXRC-xxx200x-C-8x-SE	800	RG1	RG1	RG1	RG1
	1110	RG1	RG1	RG1	RG2
	1470	RG1	RG1	RG2	RG2
	1750	RG1	RG2	RG2	RG2
BXRC-xxx200x-D-8x-SE	865	RG1	RG1	RG1	RG1
	1195	RG1	RG1	RG1	RG2
	1250	RG1	RG1	RG2	RG2

Notes for Table 5:

1. Eye safety classification for the use of Bridgelux V Series LED arrays is in accordance with specification IEC/TR 62778: Application of IEC 62471 for the assessment of blue light hazard to light sources and luminaires.
2. For products classified as RG2 at 4000K, Ethr= 1980 lx.
3. For products classified as RG2 at 5000K Ethr= 1530 lx.
4. For products classified as RG2 at 6500K, Ethr= 1170 lx.
5. Please contact your Bridgelux sales representative for Ethr values at specific drive currents and CCTs not listed.

Absolute Maximum Ratings

Table 6: Maximum Ratings

Parameter	Maximum Rating		
LED Junction Temperature (T_j)	150°C		
Storage Temperature	-40°C to +105°C		
Operating Case Temperature ¹ (T_c)	105°C		
Soldering Temperature ²	300°C or lower for a maximum of 6 seconds		
	BXRC-xxx200x-B-8x-SE	BXRC-xxx200x-C-8x-SE	BXRC-xxx200x-D-8x-SE
Maximum Drive Current ³	1250 mA	1750 mA	1250 mA
Maximum Peak Pulsed Drive Current ⁴	1400 mA	1960 mA	1400 mA
Maximum Reverse Voltage ⁵	-60V	-60V	-55V

Notes for Table 6:

1. For IEC 62717 requirement, please consult your Bridgelux sales representative.
2. Refer to Bridgelux Application Note AN121: Assembly Considerations for Bridgelux Vero SELED Arrays.
3. Arrays may be driven at higher currents however lumen maintenance may be reduced and warranty will not apply.
4. Bridgelux recommends a maximum duty cycle of 10% and pulse width of 20 ms when operating LED Arrays at maximum peak pulsed current specified. Maximum peak pulsed currents indicate values where LED Arrays can be driven without catastrophic failures.
5. Light emitting diodes are not designed to be driven in reverse voltage and will not produce light under this condition. Maximum rating provided for reference only.

Performance Curves

Figure 1: Vero SE 13B Drive Current vs. Voltage

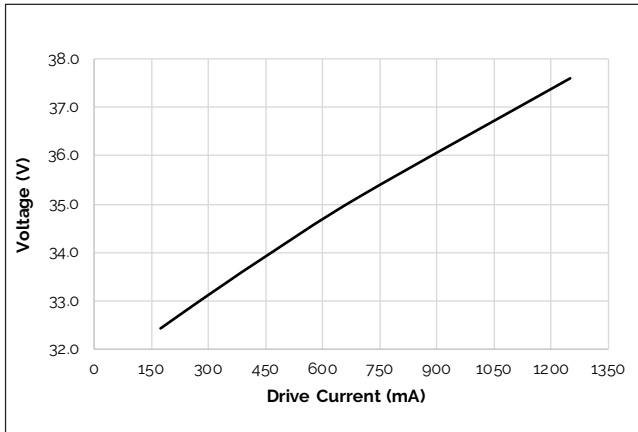

Figure 2: Vero SE 13C Drive Current vs. Voltage

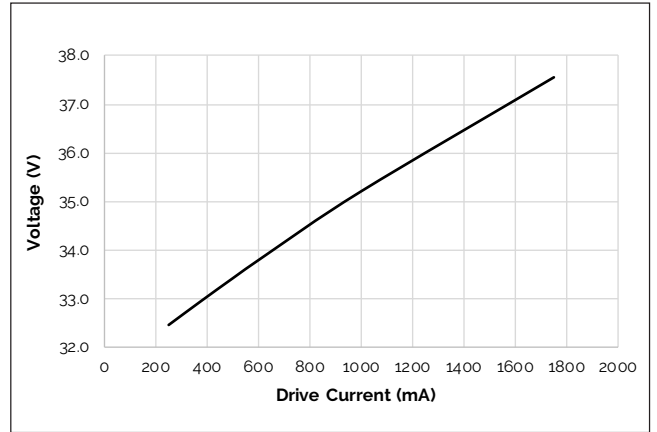

Figure 3: Vero SE 13D Drive Current vs. Voltage

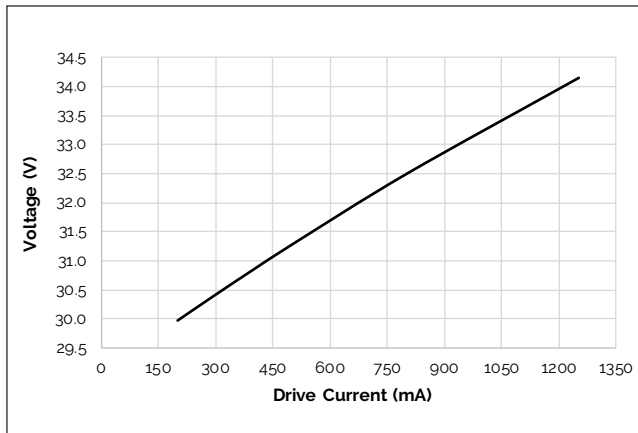

Figure 4: Vero SE 13B Typical Relative Flux vs. Current

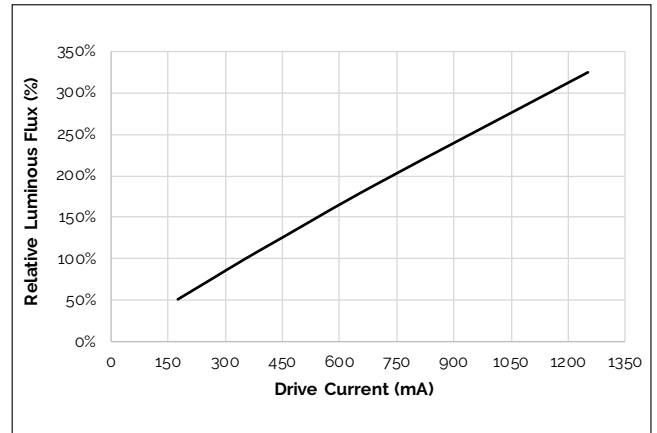

Figure 5: Vero SE 13C Typical Relative Flux vs. Current

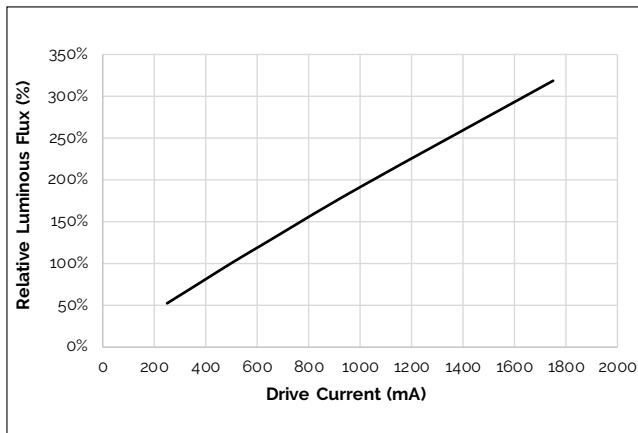
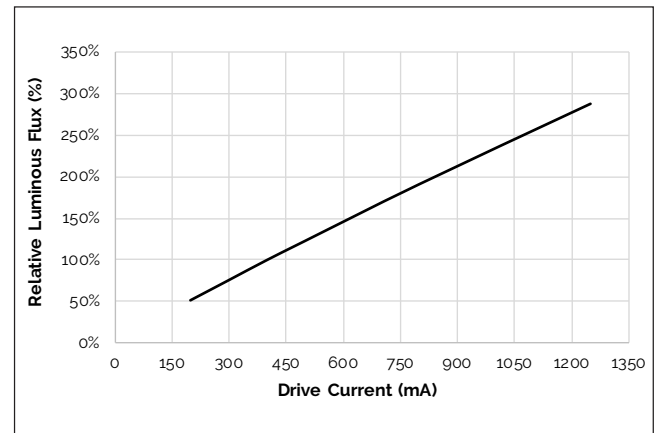

Figure 6 Vero SE 13D Typical Relative Flux vs. Current



Note for Figure 1-6:

1. Bridgelux does not recommend driving high power LEDs at low currents. Doing so may produce unpredictable results. Pulse width modulation (PWM) is recommended for dimming effects.
2. Products tested under pulsed condition (10ms pulse width) at nominal test current where T_j (junction temperature) = T_c (case temperature) = 25°C.

Performance Curves

Figure 7: Typical DC Flux vs. Case Temperature

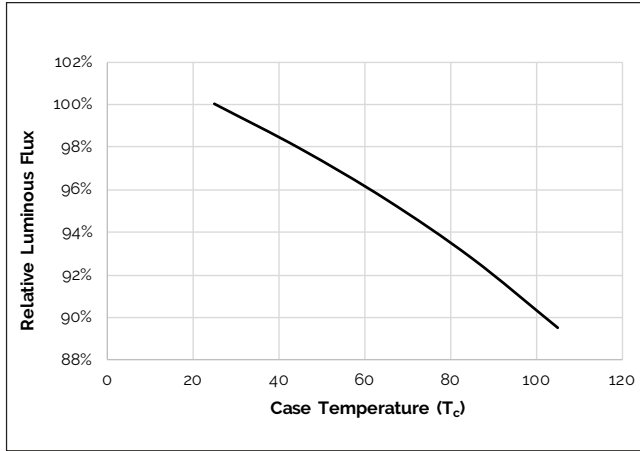

Figure 8: Typical DC ccy Shift vs. Case Temperature

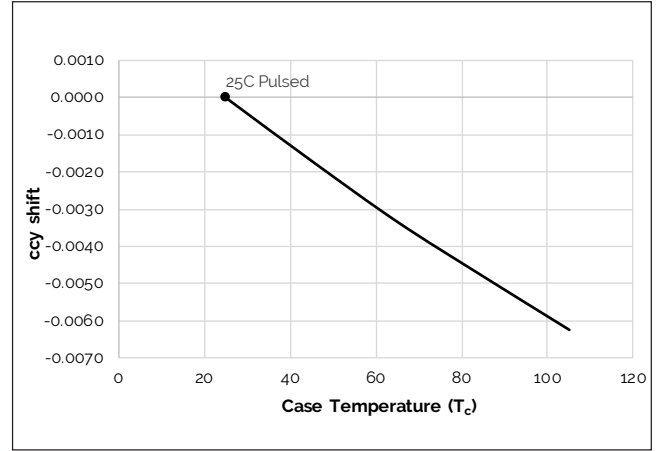
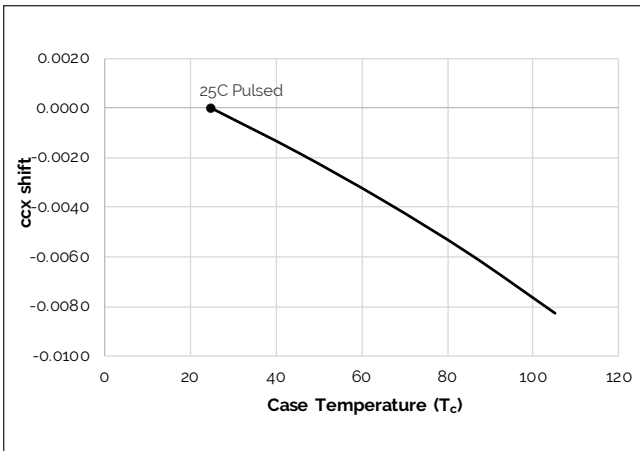

Figure 9: Typical DC ccx Shift vs. Case Temperature



Notes for Figures 7-9:

1. Characteristics shown for warm white based on 3000K and 80 CRI.
2. Characteristics shown for neutral white based on 4000K and 80 CRI.
3. Characteristics shown for cool white based on 5000K and 70 CRI.
4. For other color SKUs, the shift in color will vary. Please contact your Bridgelux Sales Representative for more information.

Typical Radiation Pattern

Figure 10: Typical Spatial Radiation Pattern

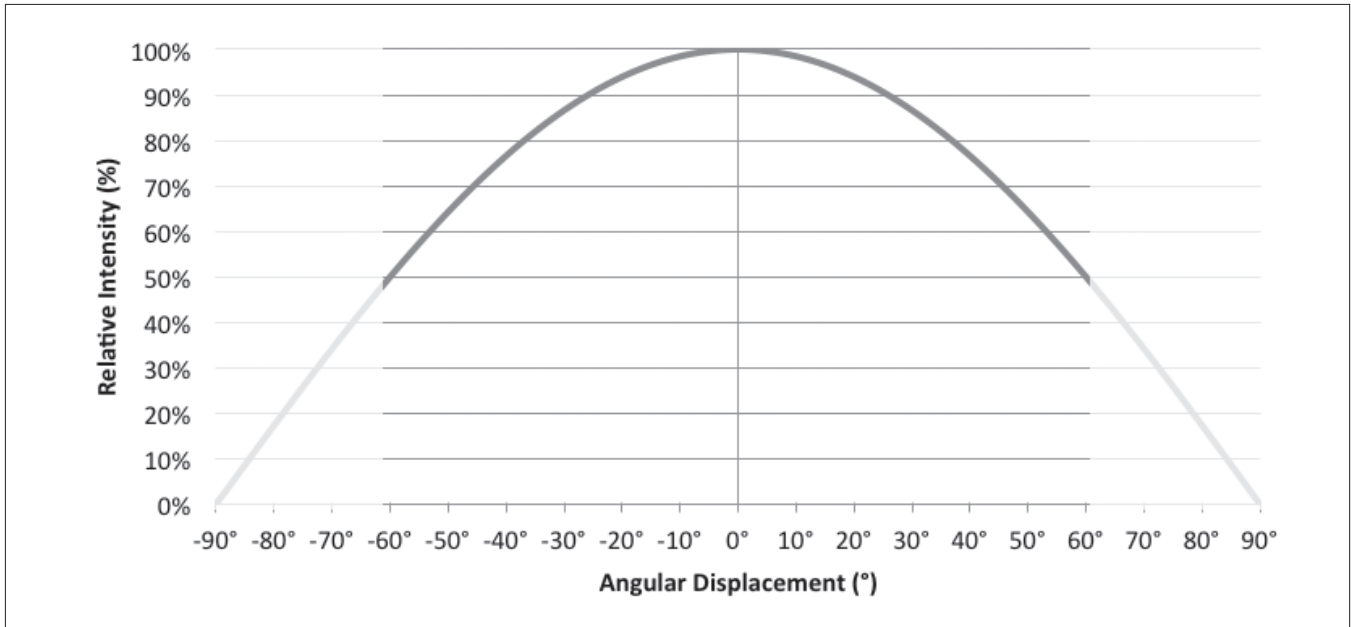

Note for Figure 10:

1. Typical viewing angle is 120°.
2. The viewing angle is defined as the off axis angle from the centerline where intensity is ½ of the peak value.

Figure 11: Typical Polar Radiation Pattern

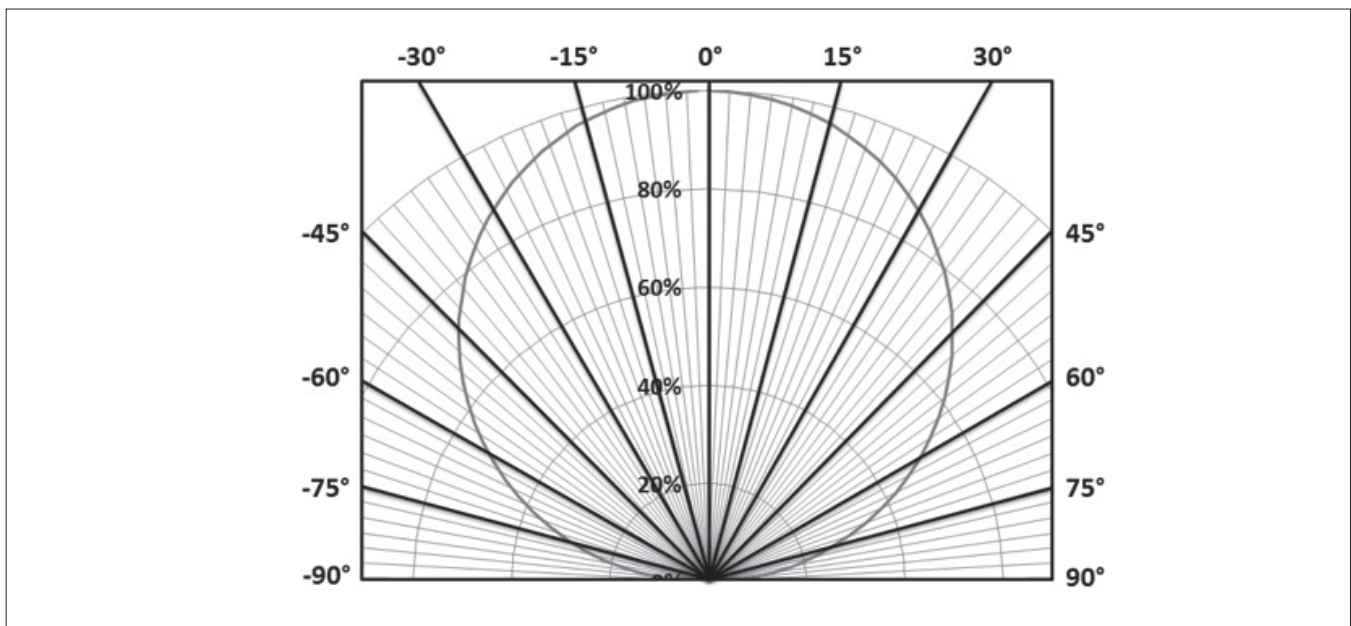

Typical Color Spectrum

Figure 12: Typical Color Spectrum

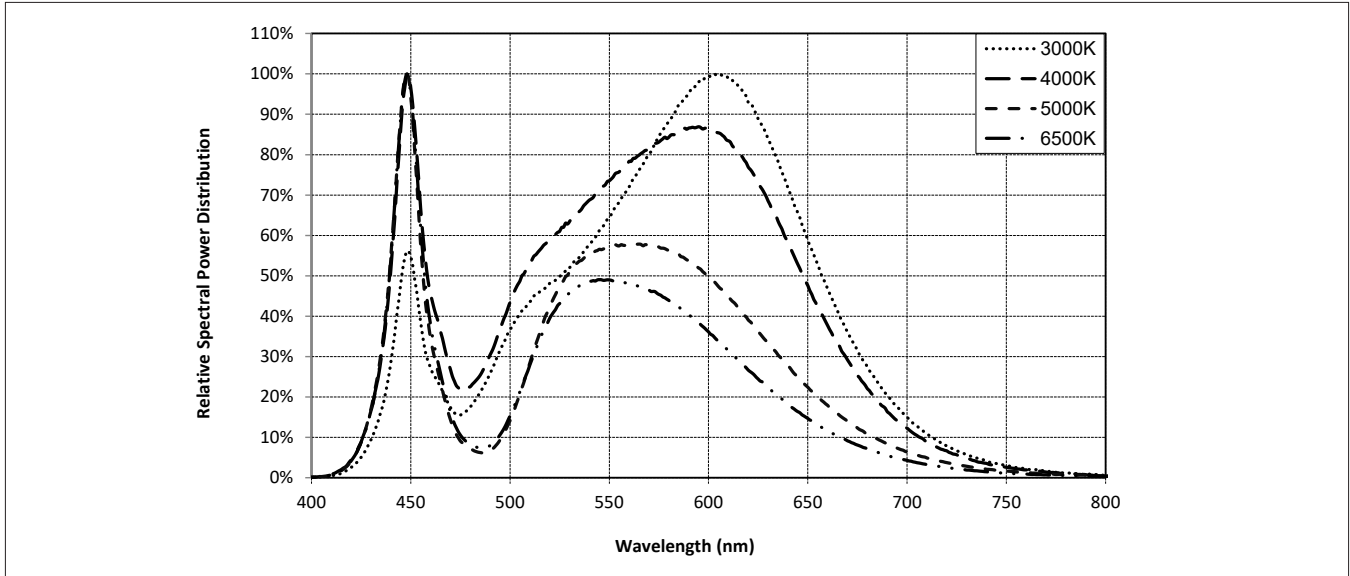

Note for Figure 12:

1. Color spectra measured at nominal current for $T_j = T_c = 25^\circ\text{C}$.
2. Color spectra shown is 3000K and 80 CRI.
3. Color spectra shown is 4000K and 80 CRI.
4. Color spectra shown is 5000K and 70 CRI.
4. Color spectra shown is 6500K and 70 CRI.

Mechanical Dimensions

Figure 13: Drawing for Vero SE 13 LED Array

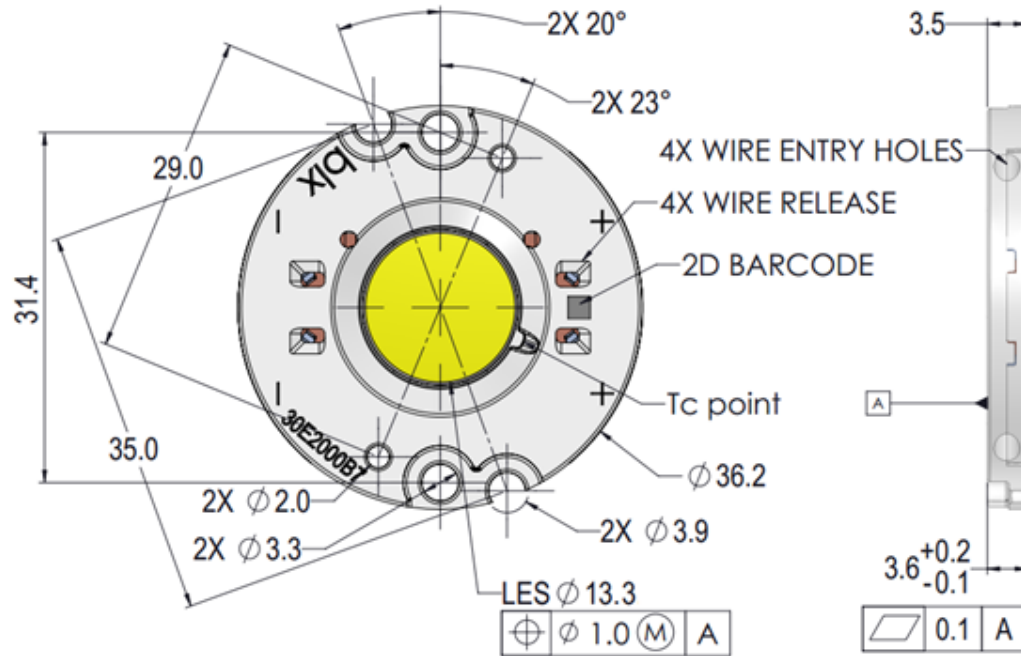

Notes for Figure 13:

1. Drawings are not to scale.
2. Drawing dimensions are in millimeters.
3. Unless otherwise specified, tolerances are $\pm 0.1\text{mm}$.
4. Mounting holes (2X) are for M3 screws.
5. Bridgelux recommends two tapped holes for mounting screws with $31.4 \pm 0.10\text{mm}$ center-to-center spacing.
6. Screws with flat shoulders (pan, dome, button, round, truss, mushroom) provide optimal torque control. Do NOT use flat, countersink, or raised head screws.
7. The optical center of the LED Array is nominally defined by the mechanical center of the array to a tolerance of $\pm 0.2\text{mm}$.
8. Bridgelux maintains a flatness of 0.10mm across the mounting surface of the array

Color Binning Information

Figure 14: Warm and Neutral White Test Bins in xy Color Space

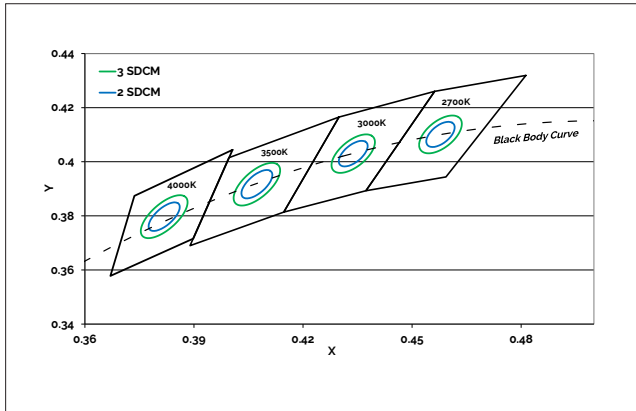

Note: Pulsed Test Conditions, $T_c = 25^\circ\text{C}$

Figure 15: Cool White Test Bins in xy Color Space

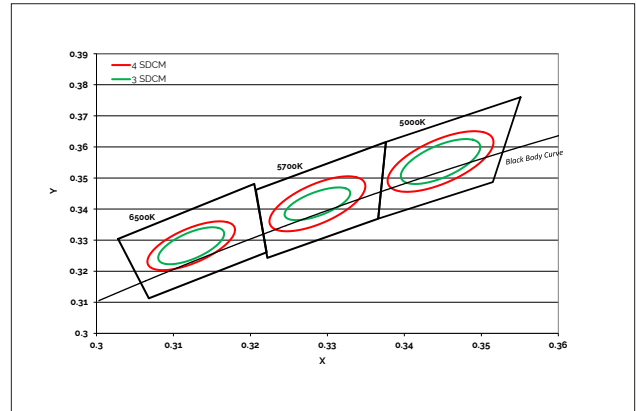

Note: Pulsed Test Conditions, $T_c = 25^\circ\text{C}$

Table 7: Warm and Neutral White xy Bin Coordinates and Associated Typical CCT

Bin Code	2700K	3000K	3500K	4000K
ANSI Bin (for reference only)	(2580K - 2870K)	(2870K - 3220K)	(3220K - 3710K)	(3710K - 4260K)
83 (3 SDCM)	(2651K - 2794K)	(2968K - 3136K)	(3369K - 3586K)	(3851K - 4130K)
82 (2 SDCM)	(2674K - 2769K)	(2995K - 3107K)	(3404K - 3548K)	(3895K - 4081K)
Center Point (x,y)	(0.4578, 0.4101)	(0.4338, 0.403)	(0.4073, 0.3917)	(0.3818, 0.3797)

Table 8: Cool White xy Bin Coordinates and Associated Typical CCT (product is hot targeted to $T_c = 85^\circ\text{C}$)

Bin Code	5000K	5700K	6500K
ANSI Bin (for reference only)	(4745K - 5311K)	(5312K - 6022K)	(6022K - 7042K)
84 (4 SDCM)	(4801K - 5282K)	(5829K - 5481K)	(6270K - 6765K)
83 (3 SDCM)	(4835K - 5215K)	(5490K - 5820K)	(6250K - 6745K)
Center Point (x,y)	(0.3447, 0.3553)	(0.3287, 0.3417)	(0.3123, 0.3282)

Packaging and Labeling

Figure 16: Drawing for Vero SE 13 Packaging Tray

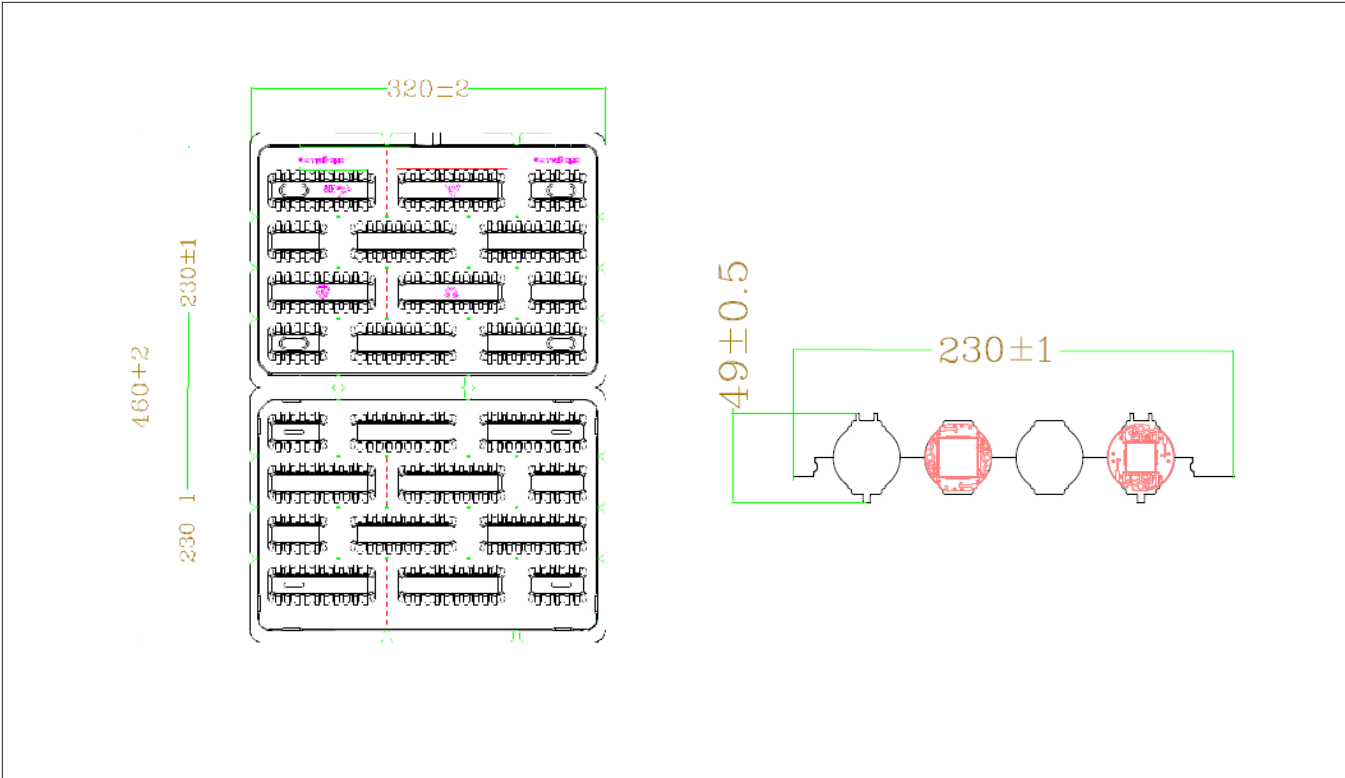

- Notes for Figure 16:
- 1. Dimensions are in millimeters.
 - 2. Drawings are not to scale.

Packaging and Labeling

Figure 17: Vero SE Series Packaging and Labeling

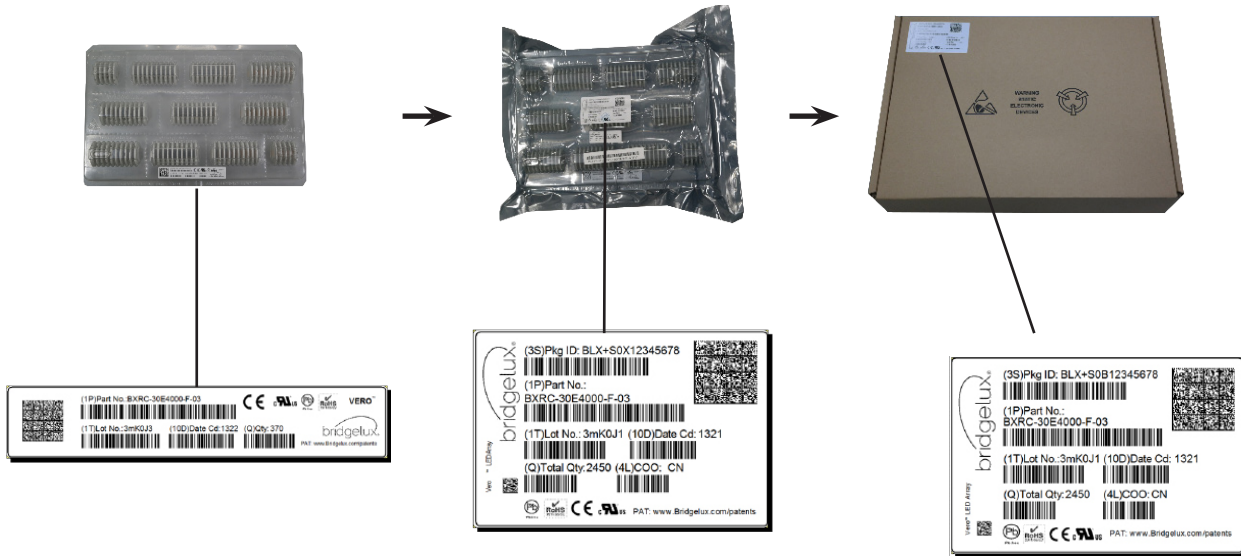

Notes for Figure 17:

1. Each tray holds 100 COBs.
2. Each tray is vacuum sealed in an anti-static bag and placed in its own box.
3. Each tray, bag and box is to be labeled as shown above.

Figure 18: Vero SE Product Labeling

Bridgelux COB arrays have laser markings on the back side of the substrate to help with product identification. In addition to the product identification markings, Bridgelux COB arrays also contain markings for internal Bridgelux manufacturing use only. The image below shows which markings are for customer use and which ones are for Bridgelux internal use only. The Bridgelux internal manufacturing markings are subject to change without notice, however these will not impact the form, function or performance of the COB array.



Customer Use- 2D Barcode
Scannable barcode provides product part number and other Bridgelux internal production information.

Customer Use- Product part number

30E2000C 83 2F

Customer Use- V_f Bin Code included to enable greater luminaire design flexibility. Refer to ANg2 for bin code definitions.

Design Resources

Application Notes

Bridgelux has developed a comprehensive set of application notes and design resources to assist customers in successfully designing with the Vero product family of LED array products. For all available application notes visit www.bridgelux.com.

Optical Source Models

Optical source models and ray set files are available for all Bridgelux products. For a list of available formats, visit www.bridgelux.com.

3D CAD Models

Three dimensional CAD models depicting the product outline of all Bridgelux Vero LED arrays are available in both IGS and STEP formats. Please contact your Bridgelux sales representative for assistance.

LM80

LM80 testing has been completed and the LM80 report is now available. Please contact your Bridgelux sales representative for LM-80 report.

Precautions

CAUTION: CHEMICAL EXPOSURE HAZARD

Exposure to some chemicals commonly used in luminaire manufacturing and assembly can cause damage to the LED array. Please consult Bridgelux Application Note AN121 for additional information.

CAUTION: RISK OF BURN

Do not touch the Vero LED array during operation. Allow the array to cool for a sufficient period of time before handling. The Vero LED array may reach elevated temperatures such that could burn skin when touched.

CAUTION

CONTACT WITH LIGHT EMITTING SURFACE (LES)

Avoid any contact with the LES. Do not touch the LES of the LED array or apply stress to the LES (yellow phosphor resin area). Contact may cause damage to the LED array.

Optics and reflectors must not be mounted in contact with the LES (yellow phosphor resin area). Optical devices may be mounted on the top surface of the plastic housing of the Vero LED array. Use the mechanical features of the LED array housing, edges and/or mounting holes to locate and secure optical devices as needed.

Disclaimers

MINOR PRODUCT CHANGE POLICY

The rigorous qualification testing on products offered by Bridgelux provides performance assurance. Slight cosmetic changes that do not affect form, fit, or function may occur as Bridgelux continues product optimization.

STANDARD TEST CONDITIONS

Unless otherwise stated, array testing is performed at the nominal drive current.

About Bridgelux: Bridging Light and Life™

At Bridgelux, we help companies, industries and people experience the power and possibility of light. Since 2002, we've designed LED solutions that are high performing, energy efficient, cost effective and easy to integrate. Our focus is on light's impact on human behavior, delivering products that create better environments, experiences and returns—both experiential and financial. And our patented technology drives new platforms for commercial and industrial luminaires.

For more information about the company, please visit
bridgelux.com
twitter.com/Bridgelux
facebook.com/Bridgelux
youtube.com/user/Bridgelux
linkedin.com/company/bridgelux-inc-_2
WeChat ID: BridgeluxInChina



46430 Fremont Boulevard
Fremont, CA 94538 U.S.A.
Tel (925) 583-8400
www.bridgelux.com

© 2020 Bridgelux, Inc. All rights reserved. Product specifications are subject to change without notice. Bridgelux, the Bridgelux stylized logo design, Vero, V Series and V Series HD are registered trademarks, and Decor Series is a trademark of Bridgelux, Inc. All other trademarks are the property of their respective owners.

Bridgelux Gen 8 Vero SE 13 Array Series Product Data Sheet DS431 Rev. A (06/2020)