

## DESCRIPTION

This document describes the specifications for the F0502 600MHz to 1000MHz dual path Sampling IF (SIF) Receiver used in Multi-mode, Multi-carrier BaseStation Receivers. Refer to the Part Number# Matrix below describing the frequency coverage of the complete series. This series is offered with high side or low side LO injection options for all UTRA bands and offers significantly better Noise and Distortion performance than currently available solutions. IF frequencies from 60MHz to 275MHz are supported.

The F0502 SIF provides 28.2dB gain and offers 47dB gain adjustment in 1dB steps and is designed to operate with a single 5V supply. Nominally, the device offers +44dBm Output IP3 using 480mA of I<sub>CC</sub>. Alternately one can configure the device in low current (LC) mode to reduce power consumption to less than 1.95 watts.

This device is packaged in a 10x10 68-pin TQFN with 50Ω single-ended RF input and 200Ω differential IF output impedances for ease of integration into the receiver lineup. The 200Ω differential IF output can easily be matched to 100Ω differential per the application drawing.

## COMPETITIVE ADVANTAGE

Renesas' Zero-Distortion™ mixer in combination with interstage filtering and Renesas' proprietary FlatNoise™ DVGA improves system SNR to the point where the external SAW filter can be eliminated. Both IP<sub>3o</sub> and NF are kept virtually flat while gain is backed off, enhancing SNR significantly under high level interferer conditions, and greatly benefiting 2G/3G/4G Multi-Carrier IF sampling receivers. In addition, total power consumption is reduced by 35% compared to conventional solutions.

- ✓ No external SAW is needed
- ✓ Reduced Power Consumption by 35%
- ✓ NF and OIP3 virtually flat for first 13dB gain reduction

The fast-settling, parallel mode gain step of 1.0 dB coupled with the excellent differential non-linearity allow for SNR to be maximized further by targeting the minimum necessary gain in small, accurate increments. The matched output does not require a terminating resistor, thus the gain and distortion performance are preserved when driving Bandpass Anti-Alias filters.

## FEATURES

- Dual Channel for Diversity / MIMO Systems
- Combines FlatNoise™ and Zero-Distortion™ technology
- 28.2dB Total Power Gain
- 47dB gain control range
- 1dB Gain Steps
- Ultra linear +44dBm IP<sub>3o</sub>
- Low NF: 9.6dB at G<sub>MAX</sub>
- 50Ω input impedance
- Matched 100Ω differential output impedance
- Ultra high +20.2dBm P1dB<sub>o</sub>
- Independent path standby mode
- Constant LO impedance in STBY mode
- 6 bit parallel control
- 60MHz to 275MHz IF frequency range
- Excellent 2<sup>nd</sup> Harmonic Rejection
- I<sub>CC</sub> = 480mA STD Mode, 390mA LC Mode
- 10 x 10 mm 68-pin VFQFPN package

## DEVICE BLOCK DIAGRAM

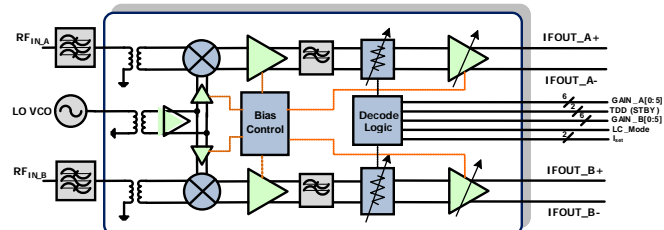

## PART NUMBER# MATRIX

Part#	RF Freq Range (MHz)	UTRA bands	IF Freq Range (MHz)	Typ. Gain (dB)	Injection
F0502	600 - 1000	5,6,8,12,13,14,17,18,19,20	60 - 275	28.2	Low & High Side
F0552	1710 - 2050	1,2,3,4,9,10,23,25,33,34,35,36,37,39	60 - 450	29	Low & High Side
F0562	2300 - 2700	7,38,40,41	60 - 450	29	Low & High Side

## Table of Contents

Absolute Maximum Ratings .....	3
F0502 Recommended Operating Conditions .....	5
F0502 Specification.....	6
Typical Operating Conditions (184 MHz IF Center).....	9
TOCs [Max Gain, STD Mode, IF = 184MHz +/- 40MHz] Gain, OIP3, OIP2 (-1-).....	10
TOCs [Max Gain, STD Mode, IF = 184MHz +/- 40MHz] 2x2, L-I, DC Current (-2-).....	11
TOCs [Swept Gain, STD Mode, IF = 184MHz, HS Injection] Gain, OIP3, IIP3 (-3-) .....	12
TOCs [Swept Gain, STD Mode, IF = 184MHz, HS Injection] OIP2, IIP2, 2x2 (-4-).....	13
TOCs [Swept Gain, STD Mode, IF = 184MHz, HS Injection] 3x3, L-I, R-I (-5-).....	14
TOCs [Swept Gain, <i>LC Mode</i> , RF=900MHz, IF = 184MHz, HS Injection] Gain, OIP3, IIP3 (-6-).....	15
TOCs [Swept Gain, <i>LC Mode</i> , RF=900MHz, IF = 184MHz, HS Injection] OIP2, Chan Iso, 2x2 (-7-) .....	16
TOCs [Swept Gain, <i>LC Mode</i> , RF=900MHz, IF = 184MHz, HS Inj] 3x3, L-I, DC Current, R-I (-8-) .....	17
Typical Operating Conditions [276 MHz IF Center].....	18
TOCs [Swept Gain, STD Mode, IF = 276MHz, HS Injection] Gain, OIP3, OIP2 (-9-) .....	19
TOCs [Swept Gain, STD Mode, IF = 276MHz, HS Injection] 2x2, 3x3, Current, R-I, ISO (-10-) .....	20
Typical Operating Conditions (80 MHz IF Center).....	21
TOCs [Swept Gain, STD Mode, IF = 80MHz, HS Injection] Gain, OIP3, OIP2 (-11-) .....	22
TOCs [Swept Gain, STD Mode, IF = 80MHz, HS Injection] 2x2, 3x3, Current, R-I, ISO (-12-).....	23
TOCs Return Loss [STD Mode] (-13-) .....	24
TOCs Noise Figure, Gain Accuracy, P1dB [STD Mode] (-14-) .....	25
TOCs M x N Spurs [LO = 1.08182 GHz, T <sub>CASE</sub> = 25C, > -90 dBc] (-15-).....	26
TOCs Histograms [N= 4584, T <sub>CASE</sub> = 25C] (-16-) .....	27
Package Outline Drawings.....	28
Pin Diagram .....	28
Pin Description .....	29
Pin Description (continued) .....	30
Digital Pin Voltage and Resistance Values .....	31
EVKIT and Typical Application Schematic .....	33
EVkit Picture .....	34
.....	34
BOM 1 and 2.....	35
IF Bias and Output Matching Circuit and BOM for Various IFs.....	36
IF Network BOM for different frequencies .....	37
Top Marking.....	37
Ordering Information.....	37
Revision History.....	37

**ABSOLUTE MAXIMUM RATINGS**

Parameter / Condition	Symbol	Min	Max	Unit
Vcc to GND	V <sub>CC</sub>	-0.3	+5.5	V
A[5:0], B[5:0], TDD_A, TDD_B, LCMode	V <sub>CNTL</sub>	-0.3	V <sub>CC</sub> + 0.25	V
MX_IFA+, MX_IFA-, MX_IFB+, MX_IFB-	V <sub>MX</sub>	-0.3	V <sub>CC</sub> + 0.25	V
IFOUT_A+, IFOUT_A-, IFOUT_B+, IFOUT_B-	V <sub>IF</sub>	+1	V <sub>CC</sub> + 0.3	V
LO1_ADJ	V <sub>LO1ADJ</sub>	+1	+3	V
LO2_ADJ	V <sub>LO2ADJ</sub>	+2.1	+4	V
MX_IF_BiasA, MX_IF_BiasB	V <sub>BIAS</sub>	-0.3	+0.3	V
ISET_A, ISET_B to GND	V <sub>ISET</sub>	-0.3	+2.2	V
LO_IN, RFIN_A, RFIN_B	V <sub>RF</sub>	-0.3	+0.3	V
RF Input Power (RFIN_A, RFIN_B)	P <sub>RFMAX</sub>		+20	dBm
LO Input Power (LO_IN)	P <sub>LOMAX</sub>		+20	dBm
Continuous Power Dissipation	P <sub>DISS</sub>		3	W
Operating Case Temperature (T <sub>c</sub> )	T <sub>OP</sub>	-40	+105	°C
Maximum Junction Temperature	T <sub>Jmax</sub>		+150	°C
Storage Temperature Range	T <sub>ST</sub>	-65	+150	°C
Lead Temperature (soldering, 10s)	T <sub>LEAD</sub>		+260	°C
ESD Voltage– HBM (Per JESD22-A114)	V <sub>ESDHBM</sub>		Class 1C (1000V)	
ESD Voltage – CDM (Per JESD22-C101)	V <sub>ESDCDM</sub>		Class III (500V)	

Stresses above those listed above may cause permanent damage to the device. Functional operation of the device at these or any other conditions above those indicated in the operational section of this specification is not implied. Exposure to absolute maximum rating conditions for extended periods may affect device reliability.

**PACKAGE THERMAL AND MOISTURE CHARACTERISTICS**

θ <sub>JA</sub> (Junction – Ambient)	25°C/W
θ <sub>JC</sub> (Junction – Case) The Case is defined as the exposed paddle	3°C /W
Moisture Sensitivity Rating (Per J-STD-020)	MSL 3

**Truth Table – Channel A & B**

Gain Set Target	Gain CodeWord	Code Name	Gain Set Target	Gain CodeWord	Code Name	Gain Set Target	Gain CodeWord	Code Name
27	000000	G <sub>27</sub>	5	010110	G <sub>5</sub>	-17	101100	G <sub>-17</sub>
26	000001	G <sub>26</sub>	4	010111	G <sub>4</sub>	-18	101101	G <sub>-18</sub>
25	000010	G <sub>25</sub>	3	011000	G <sub>3</sub>	-19	101110	G <sub>-19</sub>
24	000011	G <sub>24</sub>	2	011001	G <sub>2</sub>	-20	101111	G <sub>-20</sub>
23	000100	G <sub>23</sub>	1	011010	G <sub>1</sub>	-20	110000	G <sub>-20</sub>
22	000101	G <sub>22</sub>	0	011011	G <sub>0</sub>	-20	110001	G <sub>-20</sub>
21	000110	G <sub>21</sub>	-1	011100	G <sub>-1</sub>	-20	110010	G <sub>-20</sub>
20	000111	G <sub>20</sub>	-2	011101	G <sub>-2</sub>	-20	110011	G <sub>-20</sub>
19	001000	G <sub>19</sub>	-3	011110	G <sub>-3</sub>	-20	110100	G <sub>-20</sub>
18	001001	G <sub>18</sub>	-4	011111	G <sub>-4</sub>	-20	110101	G <sub>-20</sub>
17	001010	G <sub>17</sub>	-5	100000	G <sub>-5</sub>	-20	110110	G <sub>-20</sub>
16	001011	G <sub>16</sub>	-6	100001	G <sub>-6</sub>	-20	110111	G <sub>-20</sub>
15	001100	G <sub>15</sub>	-7	100010	G <sub>-7</sub>	-20	111000	G <sub>-20</sub>
14	001101	G <sub>14</sub>	-8	100011	G <sub>-8</sub>	-20	111001	G <sub>-20</sub>
13	001110	G <sub>13</sub>	-9	100100	G <sub>-9</sub>	-20	111010	G <sub>-20</sub>
12	001111	G <sub>12</sub>	-10	100101	G <sub>-10</sub>	-20	111011	G <sub>-20</sub>
11	010000	G <sub>11</sub>	-11	100110	G <sub>-11</sub>	-20	111100	G <sub>-20</sub>
10	010001	G <sub>10</sub>	-12	100111	G <sub>-12</sub>	-20	111101	G <sub>-20</sub>
9	010010	G <sub>9</sub>	-13	101000	G <sub>-13</sub>	-20	111110	G <sub>-20</sub>
8	010011	G <sub>8</sub>	-14	101001	G <sub>-14</sub>	-20	111111	G <sub>-20</sub>
7	010100	G <sub>7</sub>	-15	101010	G <sub>-15</sub>			
6	010101	G <sub>6</sub>	-16	101011	G <sub>-16</sub>			

**F0502 RECOMMENDED OPERATING CONDITIONS**

Parameter	Symbol	Conditions	Min	Typ	Max	Units
Supply Voltage	$V_{CC}$	All $V_{CC}$ pins	4.75		5.25	V
LO Power	$P_{LO}$		-3		+3	dBm
Operating Temperature Range	$T_{CASE}$	Case Temperature	-40		+105	°C
RF Frequency Range	$F_{RF}$		600		1000	MHz
LO Frequency Range	$F_{LO}$		600		1225	
IF Frequency Range	$F_{IF}$		60		275	

### F0502 SPECIFICATION

F0502 Typical Application Circuit, when operated as a Sampling IF Receiver,  $V_{CC} = +5.00V$ ,  $T_C = +25^{\circ}C$ ,  $F_{RF} = 850MHz$ ,  $F_{IF} = 184MHz$ ,  $F_{LO} = 1034MHz$ ,  $P_{LO} = 0\text{ dBm}$ , Max gain setting, IF output power = +3dBm per tone,  $TDD_{-} = \text{LOW}$ , STD Mode, unless otherwise stated. EVkit PCB, connector and IF transformer losses are de-embedded unless otherwise noted.

Parameter	Symbol	Conditions	Min	Typ	Max	Units
Logic Input High	$V_{IH}$	For all control pins	<b>1.07</b>			V
Logic Input Low	$V_{IL}$	For all control pins			<b>0.68</b>	V
Logic Current	$I_{IH}, I_{IL}$	For all control pins	<b>-150</b>		<b>10</b>	$\mu A$
Total Supply Current	$I_{CC}$	<b>STD Mode</b>		480	<b>545<sup>1</sup></b>	mA
		<b>LC Mode</b>		390	<b>440</b>	
		Standby Mode $STBY = V_{IH}$		26	<b>36</b>	
Conversion Power Gain	G	<b>STD Mode</b>	<b>26.2</b>	28.2	<b>30.2</b>	dB
		<b>LC Mode</b>	<b>26.2</b>	28.2	<b>30.2</b>	
		<b>STD Mode</b> Max attenuation		-18.8		
Gain Control Range	$G_{RANGE}$			47		dB
Step Size	$G_{STEP}$			1		dB
Differential Gain Error	DNL	Between any two adjacent 1dB steps		0.1	$0.2^2$	dB
Integral Gain Error	INL	Error vs. line ( $G_{27}$ Ref)		0.2	<b>0.8</b>	dB
Phase Error	IPE	Maximum phase change between $G_{MAX}$ and any state down to $G_{-14}$		2		deg
Noise Figure	NF	<b>STD Mode</b>		9.6	10.6	dB
		<b>STD Mode</b> at $G_{MAX} - 10dB$		9.6	10.6	
		<b>LC Mode</b>		9.3	10.3	
		<b>LC Mode</b> at $G_{MAX} - 10dB$		9.3	10.3	
Noise Figure with Blocker	$NF_{BLK}$	Desired RF = 800MHz Blocker = 700MHz LO = 984MHz $P_{IN} = +4dBm$ Gain = -1dB		17.5	19	dB

**F0502 SPECIFICATION (CONTINUED)**

F0502 Typical Application Circuit, when operated as a Sampling IF Receiver,  $V_{CC} = +5.00V$ ,  $T_C = +25^\circ C$ ,  $F_{RF} = 850MHz$ ,  $F_{IF} = 184MHz$ ,  $F_{LO} = 1034MHz$ ,  $P_{LO} = 0\text{ dBm}$ , Max gain setting, IF output power = +3dBm per tone, TDD\_ = LOW, STD Mode, unless otherwise stated. EVkit PCB, connector and IF transformer losses are de-embedded unless otherwise noted.

Parameter	Symbol	Conditions	Min	Typ	Max	Units
Turn-on time	$T_{SETT1}$	Gate STBY from $V_{IH}$ to $V_{IL}$ Time for IF Signal to settle to within 0.1 dB of final value		0.17	0.20	$\mu s$
Attenuator Adjustment Settling Time	$T_{1dB}$	Any two Adjacent 1dB Steps +/-0.10 dB Pout settling		17.5	25	ns
Output IP3	OIP3	<b>STD Mode</b> 800 KHz Tone Separation	<b>40</b>	44		dBm
		<b>STD Mode</b> Gain = $G_{MAX} - 10dB$ , Pout = +1dBm per tone 800 KHz Tone Separation $-40C \leq T_{case} \leq +105C$ IF = 138MHz, LO = 988MHz IF = 184MHz, LO = 1034MHz IF = 276MHz, LO = 1126MHz	40	44		
		<b>LC Mode</b> 800 KHz Tone Separation	40	44		
Input IP3	IIP3	<b>STD Mode</b> Gain = $G_{MAX} - 22dB$ , Pin = - 5dBm/tone 800 KHz Tone Separation	21	25		dBm
		<b>LC Mode</b> Gain = $G_{MAX} - 22dB$ , Pin = -10dBm/tone 800 KHz Tone Separation		21		
1 dB Output Compression	OP1dB	<b>STD Mode</b>	<b>17.5</b>	20.2		dBm
		<b>LC Mode</b>	<b>17.5</b>	20.2		
1 dB Input Compression	IP1dB	Gain = $G_{MAX} - 30dB$	<b>STD Mode</b>	7.7	8.7	dBm
			<b>LC Mode</b>	6.5	7	

**F0502 SPECIFICATION (CONTINUED)**

F0502 Typical Application Circuit, when operated as a Sampling IF Receiver,  $V_{CC} = +5.00V$ ,  $T_C = +25^\circ C$ ,  $F_{RF} = 850MHz$ ,  $F_{IF} = 184MHz$ ,  $F_{LO} = 1034MHz$ ,  $P_{LO} = 0\text{ dBm}$ , Max gain setting, IF output power = +3dBm per tone,  $TDD\_ = LOW$ , STD Mode, unless otherwise stated. EVkit PCB, connector and IF transformer losses are de-embedded unless otherwise noted.

Parameter	Symbol	Conditions	Min	Typ	Max	Units	
2LO – 2RF Rejection		<b>STD Mode</b> Frequency = $F_{RF} + \frac{1}{2} F_{IF}$ $P_{RF} = -27dBm$		-75	-65	dBc	
		<b>STD Mode</b> , Gain = $G_{MAX} - 22dB$ , Frequency = $F_{RF} + \frac{1}{2} F_{IF}$ $P_{RF} = -5dBm$		-69	-60		
		<b>LC Mode</b> Frequency = $F_{RF} + \frac{1}{2} F_{IF}$ $P_{RF} = -27dBm$		-73	-60		
		<b>LC Mode</b> , Gain = $G_{MAX} - 22dB$ , Frequency = $F_{RF} + \frac{1}{2} F_{IF}$ $P_{RF} = -27dBm$		-69	-60		
2nd Harmonic	HD2	$P_{RF} = -27\text{ dBm}$	<b>STD Mode</b>		-81	-70	dBc
			<b>LC Mode</b>		-80	-70	
3rd Harmonic	HD3	$P_{RF} = -27\text{ dBm}$	<b>STD Mode</b>		-94	-80	dBc
			<b>LC Mode</b>		-94	-80	
Channel Isolation	ISO <sub>C</sub>	RFIN_A applied, IFOUT_A compared with IFOUT_B	<b>STD Mode</b>	45	50		dB
			<b>LC Mode</b>	45	50		
LO to IF Leakage	ISO <sub>LI</sub>		<b>STD Mode</b>		-60	-55	dBm
			<b>LC Mode</b>		-60	-55	
RF to IF leakage	ISO <sub>RI</sub>		<b>STD Mode</b>		-80	-70	dBm
			<b>LC Mode</b>		-80	-70	
LO to RF leakage	ISO <sub>LR</sub>			-44		dBm	
RFIN Impedance	Z <sub>RFIN</sub>	Single Ended		50		Ω	
LO Port Impedance	Z <sub>LO</sub>	Single Ended		50			
IF Output Impedance	Z <sub>IF</sub>	Differential		200			

- 1 – Items in min/max columns in **bold italics** are Guaranteed by Test using BOM1 components supporting 4:1 output impedance transformation to 50Ω
- 2 – Items in min/max columns that are not bold/italics are Guaranteed by Design Characterization using BOM2 components supporting 2:1 output impedance transformation to 100Ω



### TYPICAL OPERATING CONDITIONS (184 MHz IF CENTER)

Unless otherwise noted, the following conditions apply:

- Applications circuit for 100 $\Omega$  differential load with 184MHz +/- 40MHz BW into 2:1 transformer. See schematic in BOM section.
- Pout ~ +3dBm
- Measurement on Channel A
- P<sub>IN</sub> from -27dBm to -5dBm per tone (Gain Setting Adjusted to yield Pout ~ +3dBm)
- Tone Spacing = 800KHz
- Device configured in Standard Mode with High Side Injection
- T<sub>CASE</sub> = 25C, V<sub>CC</sub> = 5.00V, LO Power = 0dBm
- RF Frequency: 915MHz
- IF Frequency: 184MHz
- IF Transformer losses are de-embedded
- Input RF trace and connector losses are de-embedded
- Listed Temperatures are Case Temperature (T<sub>C</sub> = Case Temperature)
- Where noted, T<sub>A</sub> or T<sub>AMB</sub> = Ambient Temperature

TOCs [MAX GAIN, STD MODE, IF = 184MHz +/- 40MHz] GAIN, OIP3, OIP2 (-1-)

RF Gain vs. T<sub>CASE</sub> [low side inj.]

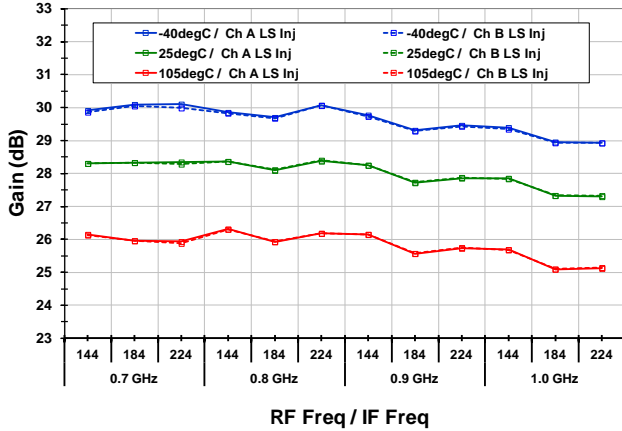

RF Gain vs. T<sub>CASE</sub> [high side inj.]

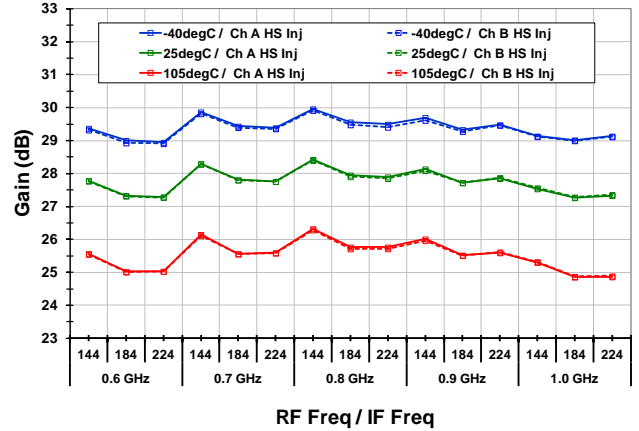

Output IP3 vs. T<sub>CASE</sub> [low side inj.]

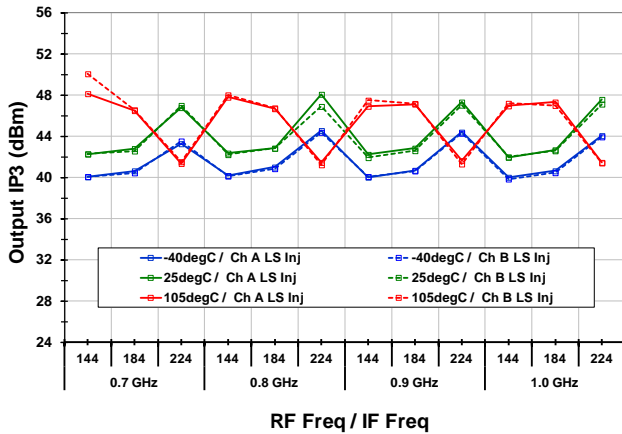

Output IP3 vs. T<sub>CASE</sub> [high side inj.]

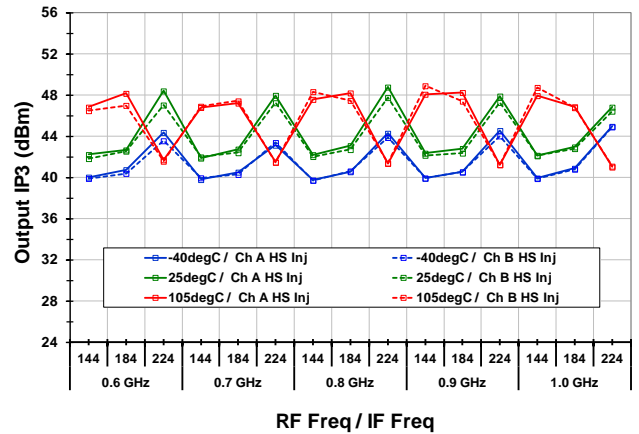

Output IP2 vs. T<sub>CASE</sub> [low side inj.]

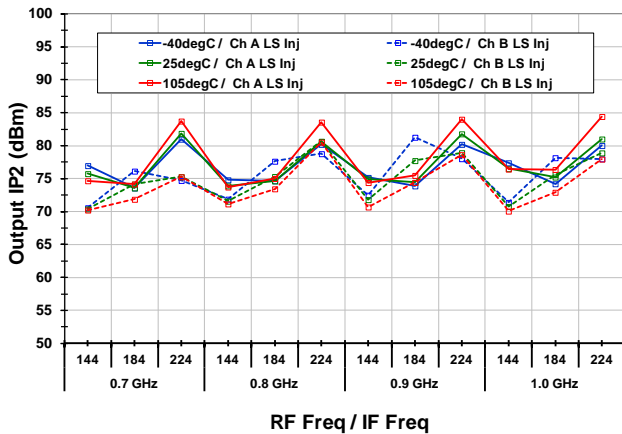

Output IP2 vs. T<sub>CASE</sub> [high side inj.]

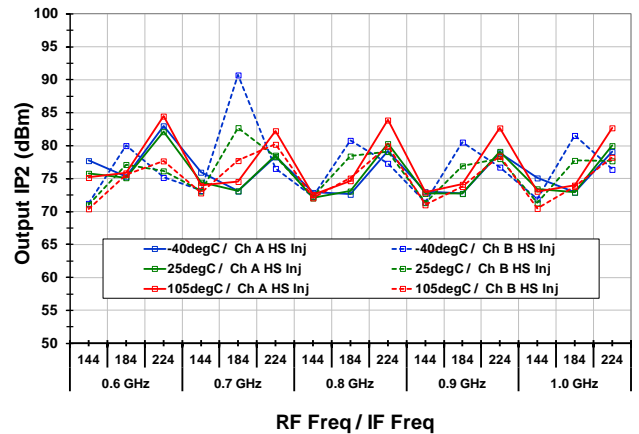

TOCs [MAX GAIN, STD MODE, IF = 184MHz +/- 40MHz] 2x2, L-I, DC CURRENT (-2-)

2RF-2LO vs. T<sub>CASE</sub> [low side inj.]

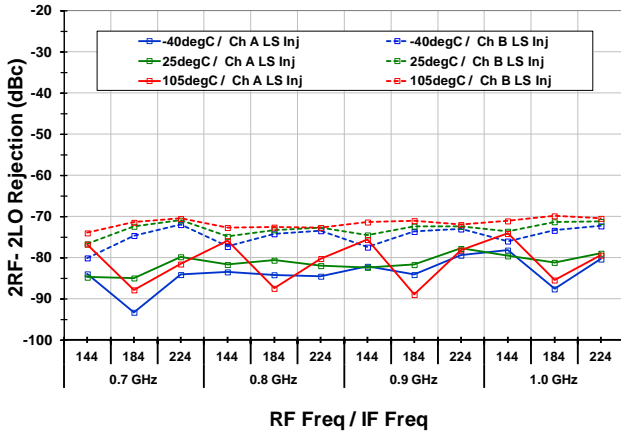

2LO-2RF vs. T<sub>CASE</sub> [high side inj.]

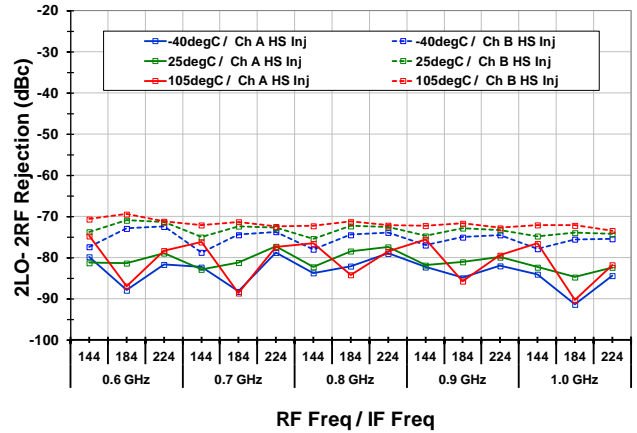

Total Current Drain [v V<sub>SUPPLY</sub>, high side inj.]

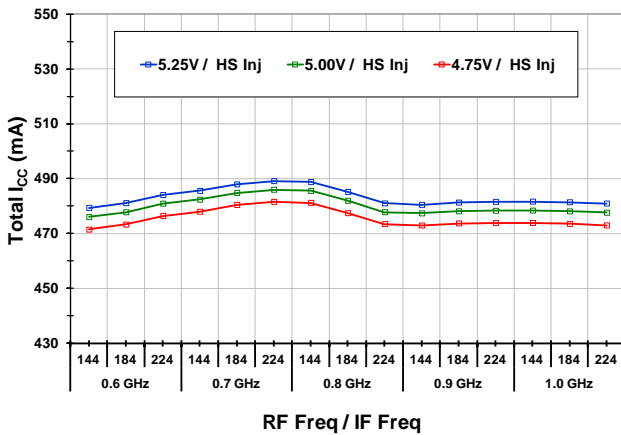

Total Current Drain [v Temp, high side inj.]

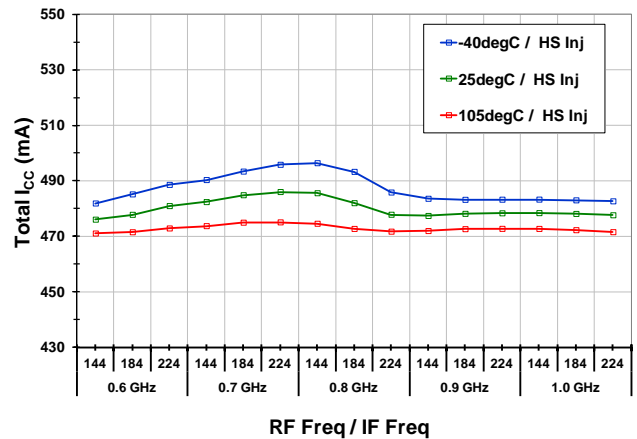

Channel Isolation [high side inj.]

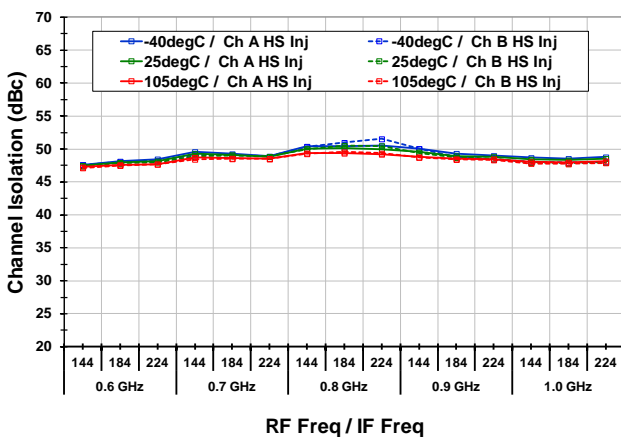

LO to IF Leakage [high side inj.]

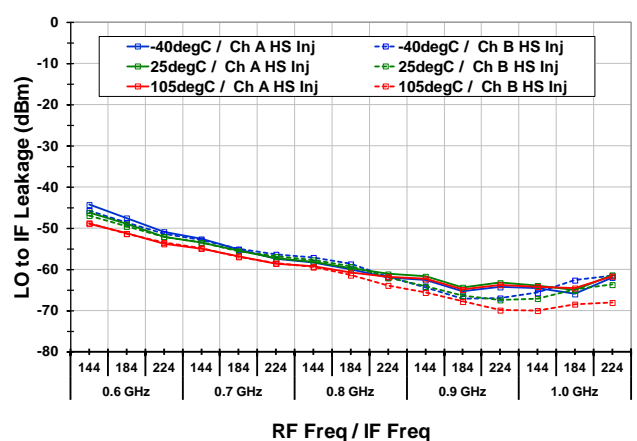

TOCs [SWEPT GAIN, STD MODE, IF = 184MHz, HS INJECTION] GAIN, OIP3, IIP3 (-3-)

RF Gain [RF=0.7 GHz]

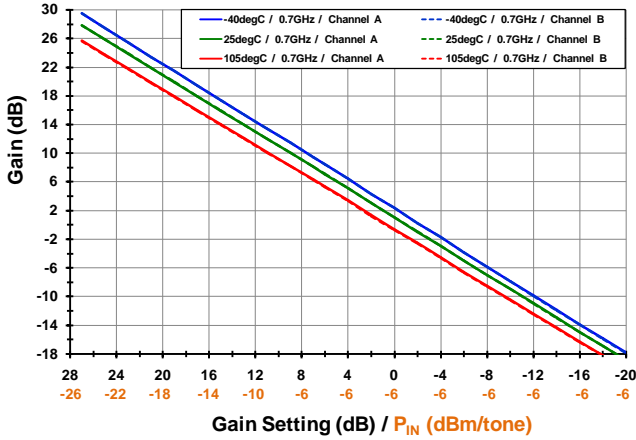

RF Gain [RF=0.9 GHz]

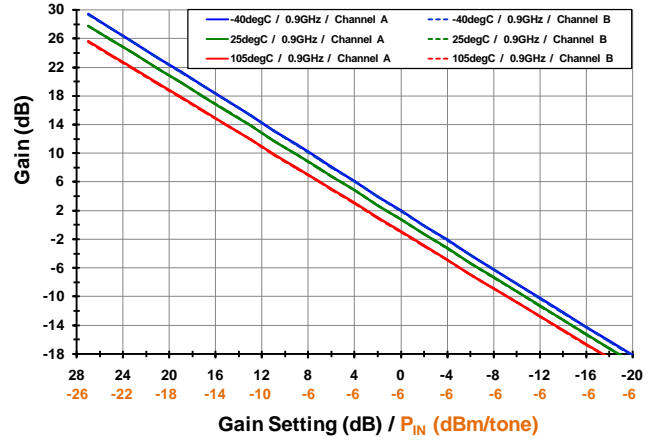

Output IP3 [RF=0.7 GHz]

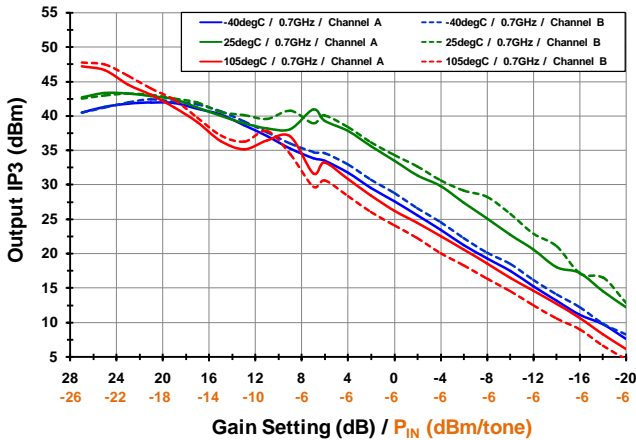

Output IP3 [RF=0.9 GHz]

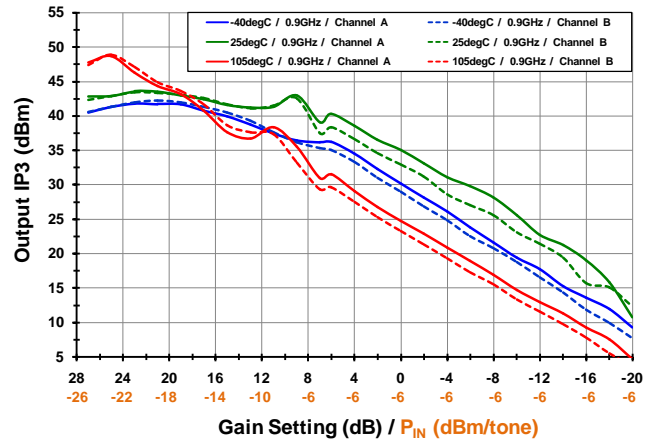

Input IP3 [RF=0.7 GHz]

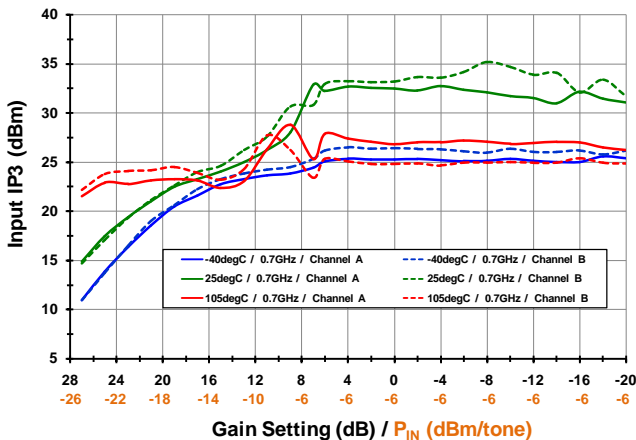

Input IP3 [RF=0.9 GHz]

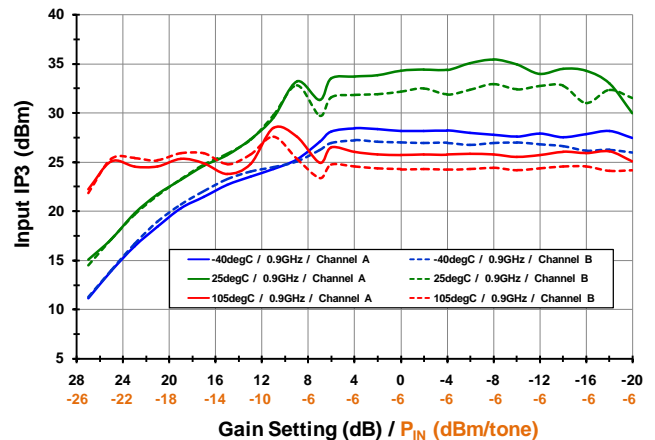

TOCs [SWEPT GAIN, STD MODE, IF = 184MHz, HS INJECTION] OIP2, IIP2, 2X2 (-4-)

Output IP2 [RF=0.7 GHz]

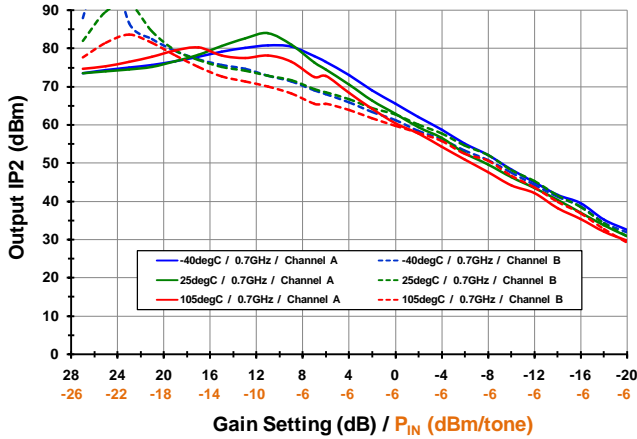

Output IP2 [RF=0.9 GHz]

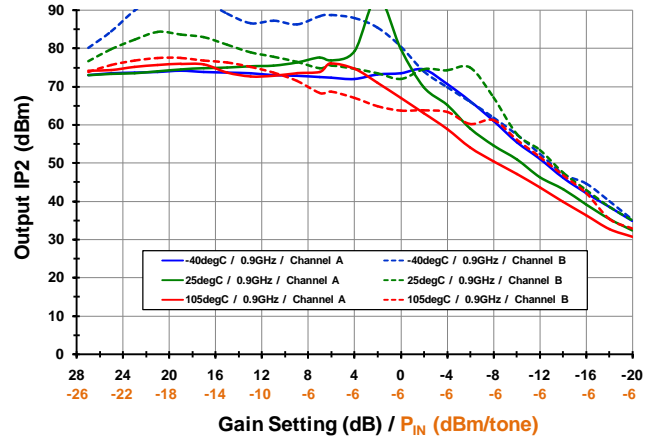

Input IP2 [RF=0.7 GHz]

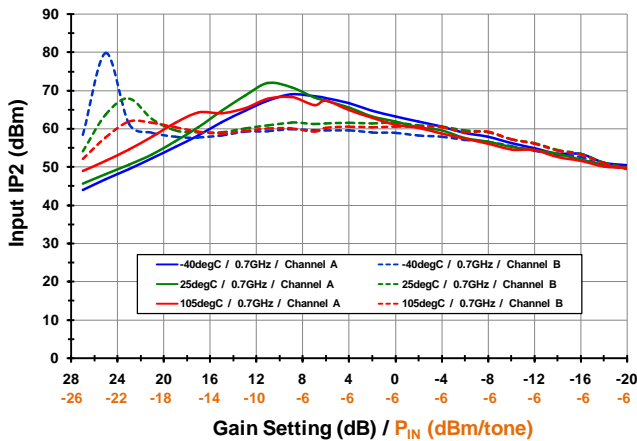

Input IP2 [RF=0.9 GHz]

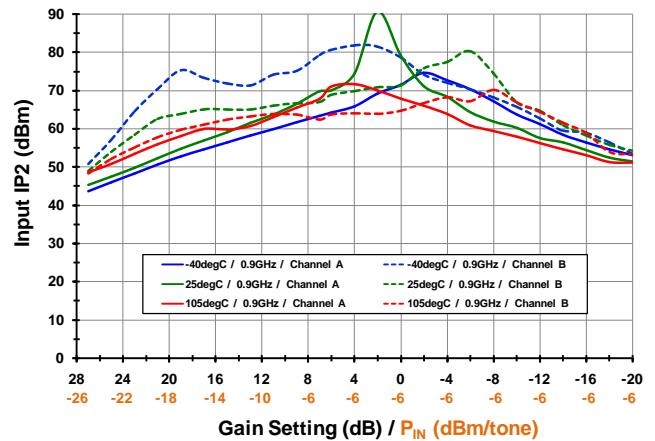

2LO-2RF Rejection [RF=0.7 GHz]

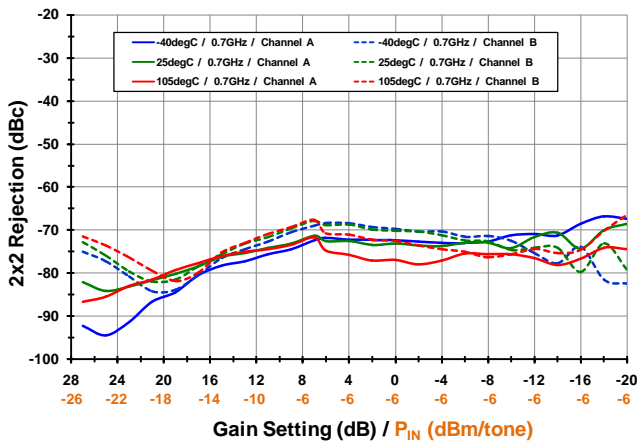

2LO-2RF Rejection [RF=0.9 GHz]

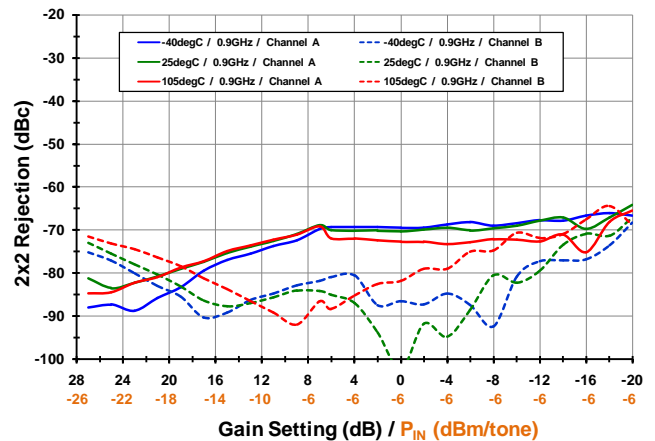

TOCs [SWEPT GAIN, STD MODE, IF = 184MHz, HS INJECTION] 3X3, L-I, R-I (-5-)

3LO-3RF Rejection [RF=0.7 GHz]

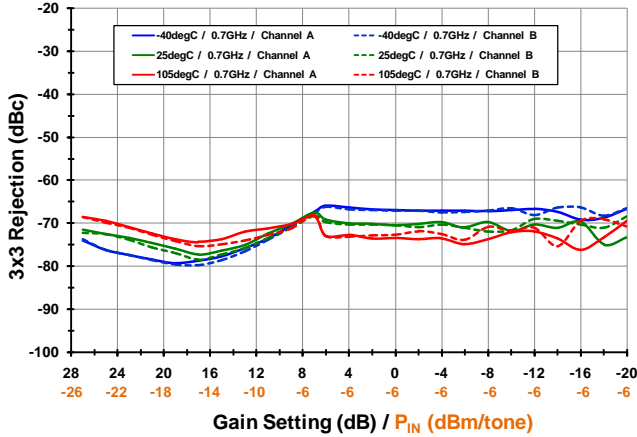

3LO-3RF Rejection [RF=0.9 GHz]

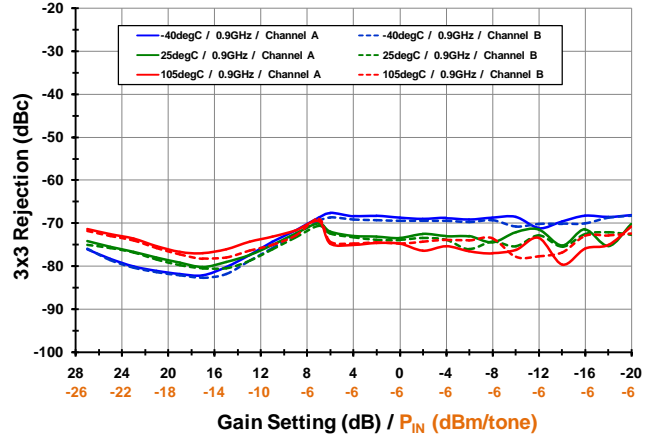

LO to IF Leakage [RF=0.7 GHz]

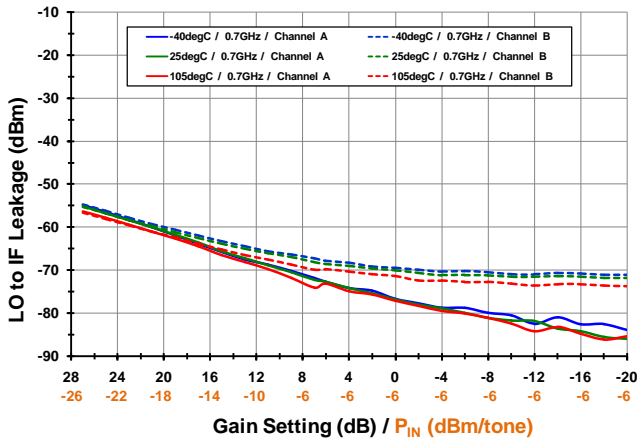

LO to IF Leakage [RF=0.9 GHz]

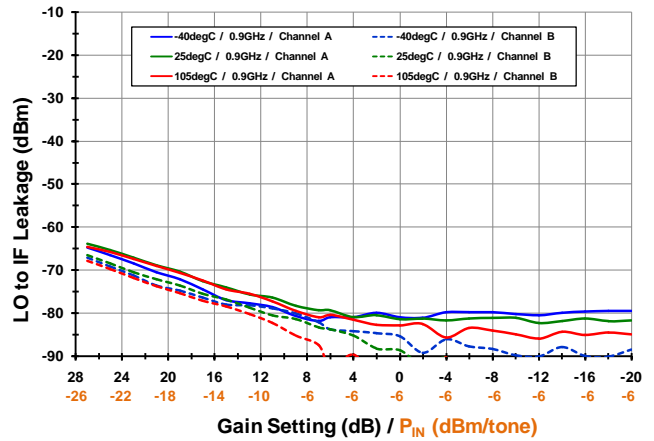

RF to IF Leakage [RF=0.7 GHz]

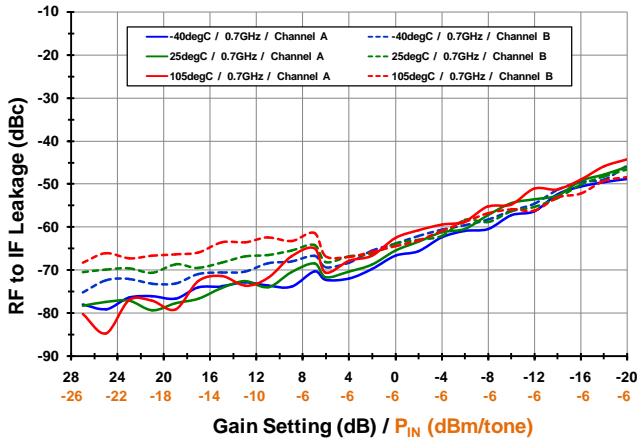

RF to IF Leakage [RF=0.9 GHz]

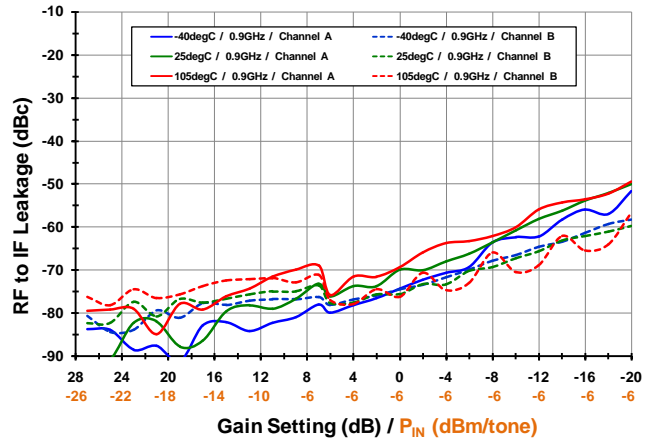

TOCs [SWEPT GAIN, LC MODE, RF=900MHz, IF = 184MHz, HS INJECTION] GAIN, OIP3, IIP3 (-6-)

RF Gain [v Temp]

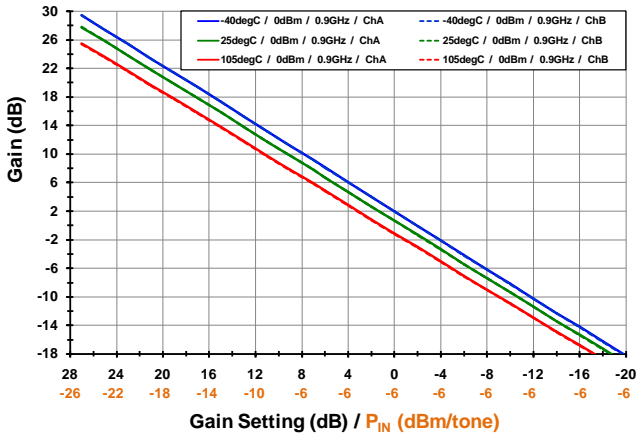

RF Gain [v LO Power]

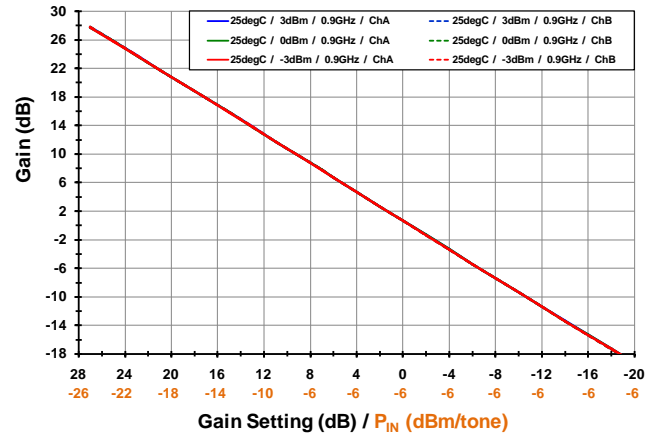

Output IP3 [v Temp]

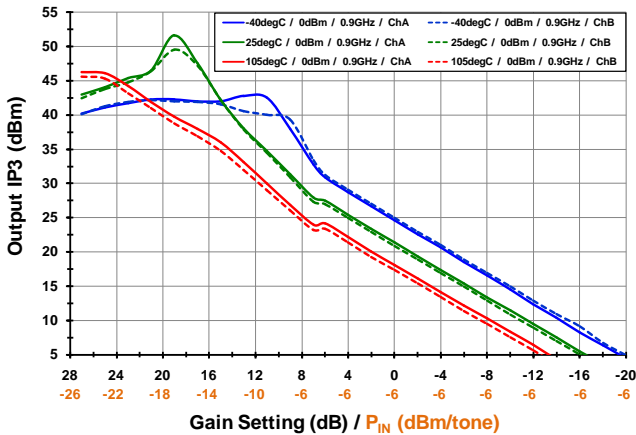

Output IP3 [v LO Power]

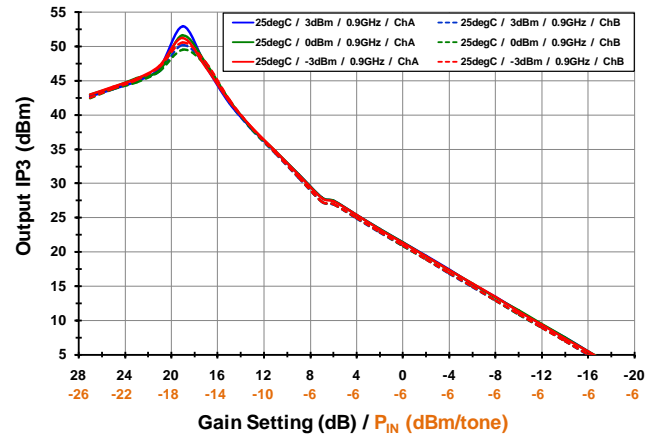

Input IP3 [v Temp]

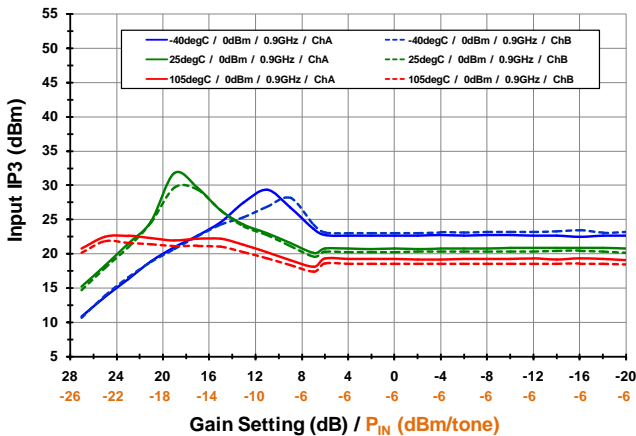

Input IP3 [v LO Power]

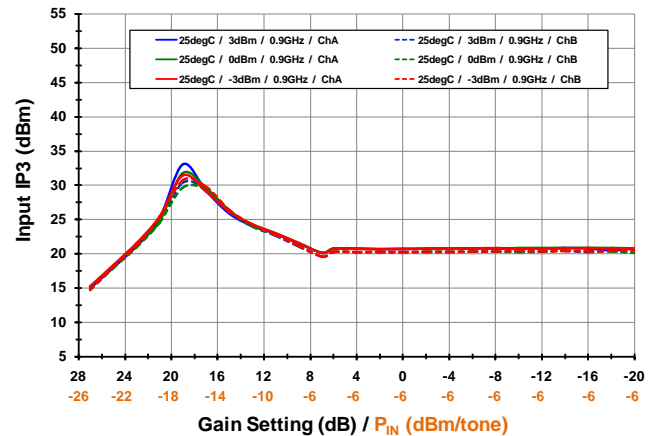

TOCs [SWEPT GAIN, *LC MODE*, RF=900MHz, IF = 184MHz, HS INJECTION] OIP2, CHAN ISO, 2X2 (-7-)

Output IP2 [v Temp]

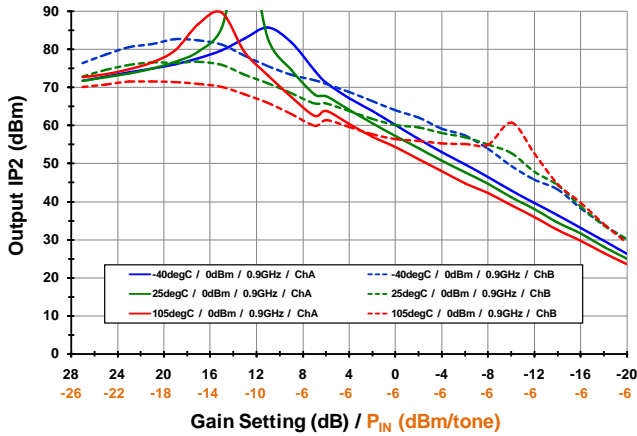

Output IP2 [v LO Power]

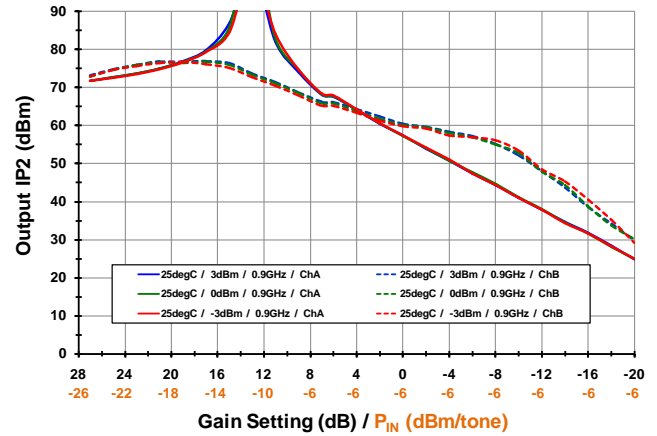

Channel Isolation [v Temp]

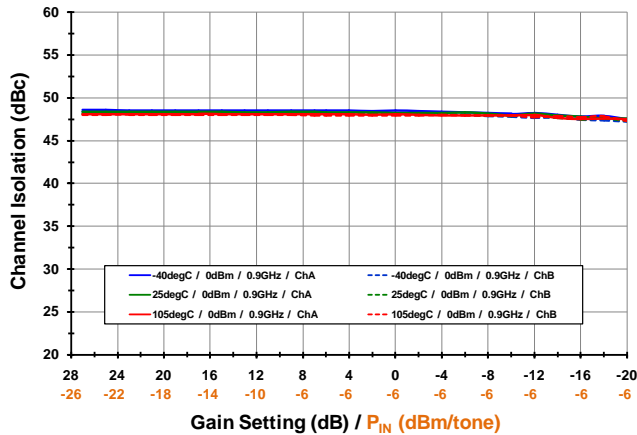

Channel Isolation [v LO Power]

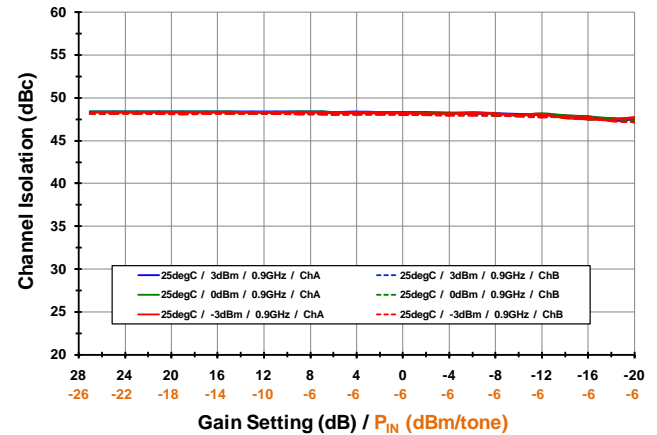

2LO-2RF Rejection [v Temp]

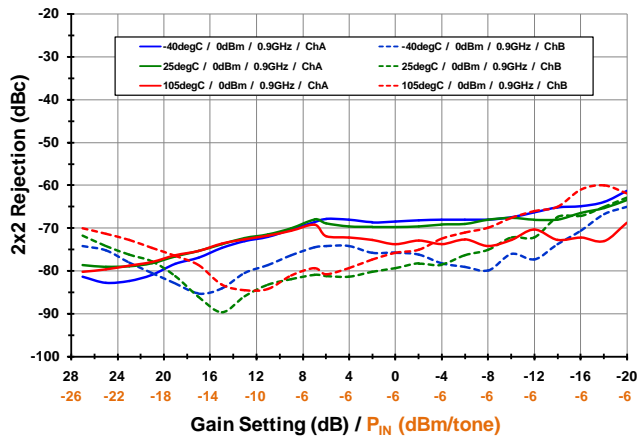

2LO-2RF Rejection [v LO Power]

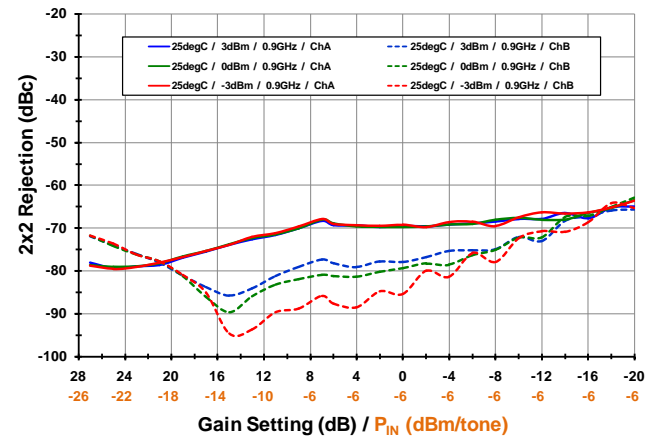



TOCs [SWEPT GAIN, *LC MODE*, RF=900MHz, IF = 184MHz, HS INJ] 3x3, L-I, DC CURRENT, R-I (-8-)

3LO-3RF Rejection [v Temp]

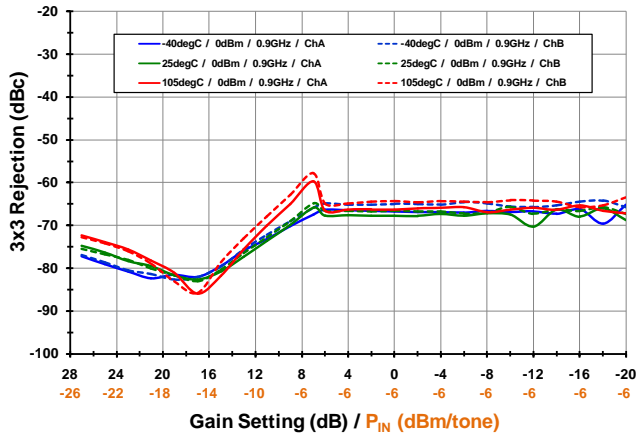

3LO-3RF Rejection [v LO Power]

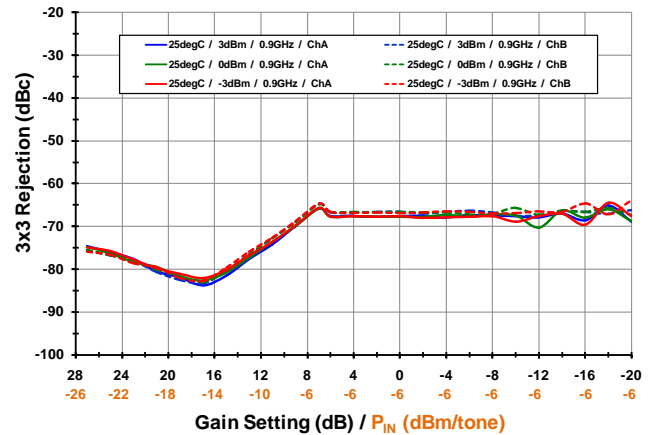

Total I<sub>CC</sub> [v LO Power]

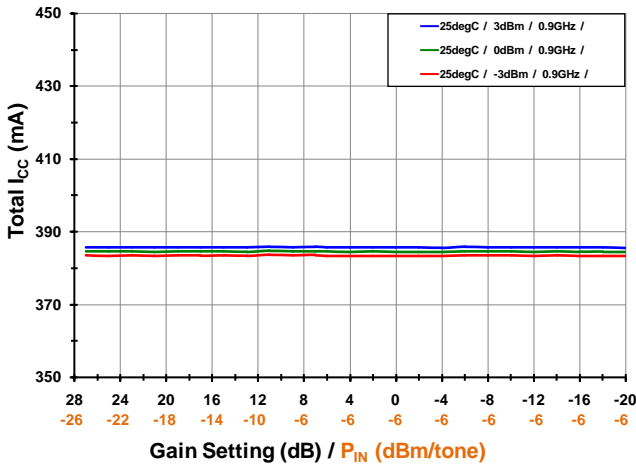

Total I<sub>CC</sub> [v Temp]

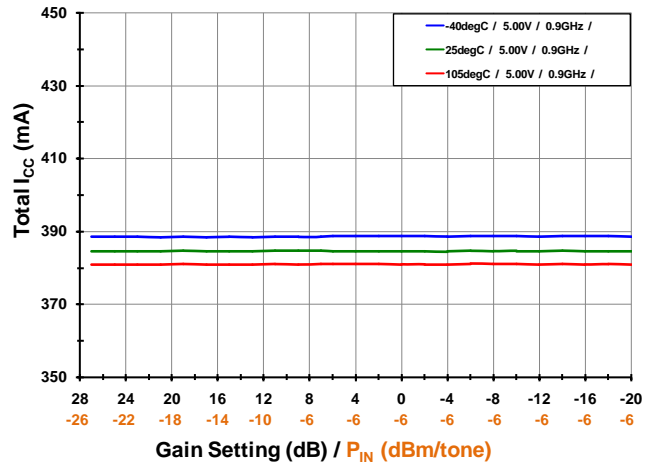

LO to IF Leakage [v LO Power]

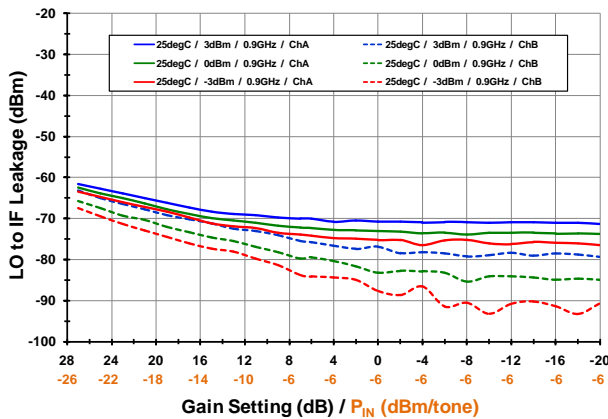

RF to IF Leakage [v Temp]

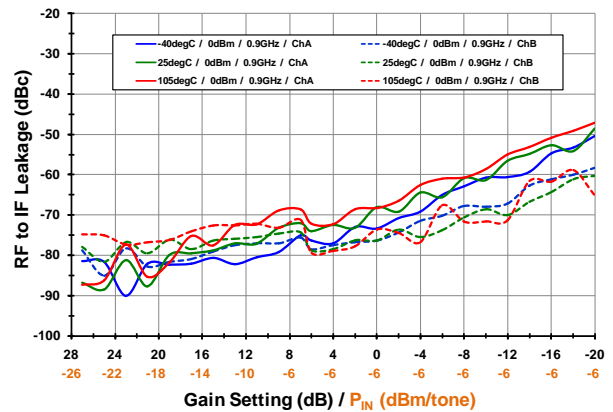

## TYPICAL OPERATING CONDITIONS [276 MHz IF CENTER]

Unless otherwise noted, the following conditions apply:

- Applications circuit for 100Ω differential load with 276MHz +/- 40MHz BW into 2:1 transformer. See schematic in BOM section.
- Pout ~ +3dBm
- Measurement on Channel A
- P<sub>IN</sub> from -27dBm to -6dBm per tone (Gain Setting Adjusted to yield Pout ~ +3dBm)
- Tone Spacing = 800KHz
- Device configured in Standard Mode with High Side Injection
- T<sub>CASE</sub> = 25C, V<sub>CC</sub> = 5.00V, LO Power = 0dBm
- RF Frequency: 915MHz
- IF Frequency: 276MHz
- IF Transformer Losses are de-embedded
- Input RF trace and connector losses are de-embedded
- Listed Temperatures are Case Temperature (T<sub>C</sub> = Case Temperature)
- Where noted, T<sub>A</sub> or T<sub>AMB</sub> = Ambient Temperature

TOCs [SWEPT GAIN, STD MODE, IF = 276MHz, HS INJECTION] GAIN, OIP3, OIP2 (-9-)

RF Gain [RF=0.7 GHz]

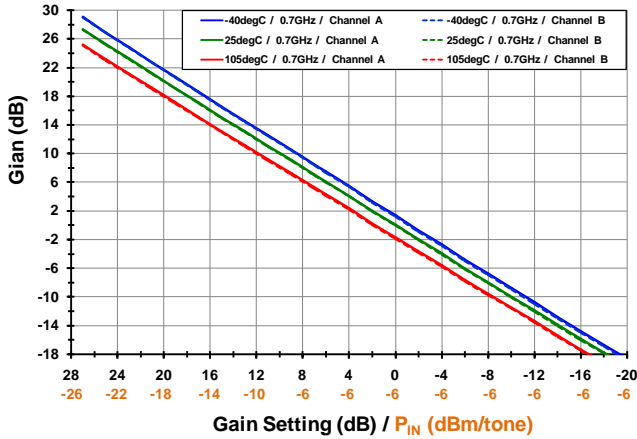

RF Gain [RF=0.9 GHz]

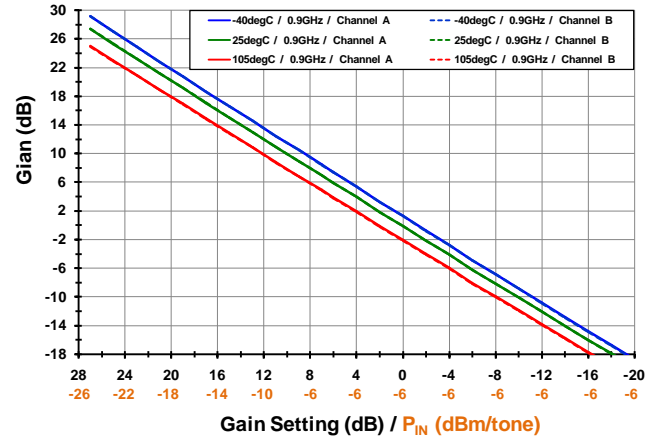

Output IP3 [RF=0.7 GHz]

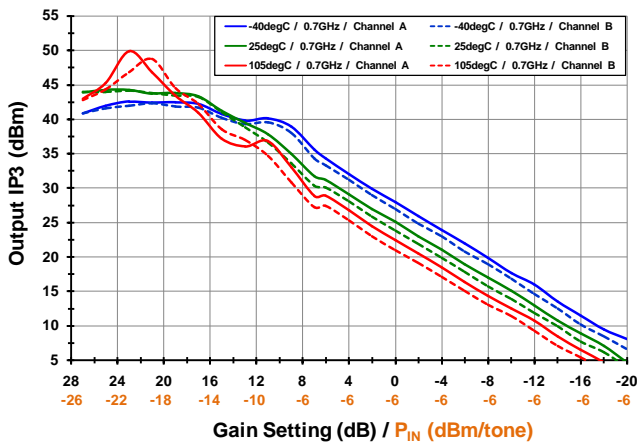

Output IP3 [RF=0.9 GHz]

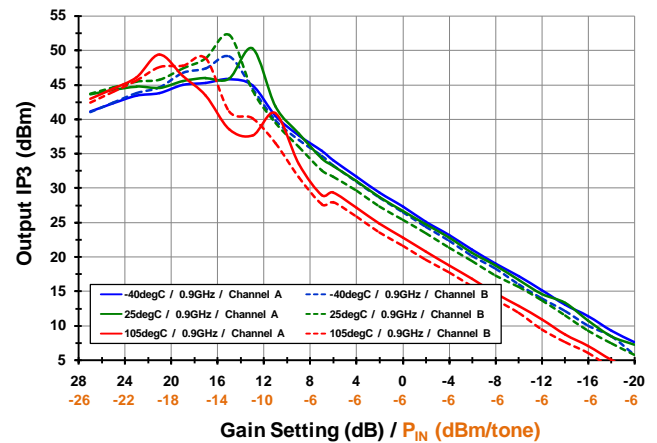

Output IP2 [RF=0.7 GHz]

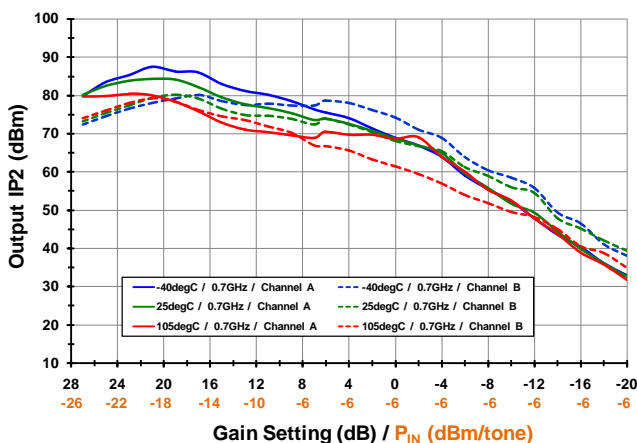

Output IP2 [RF=0.9 GHz]

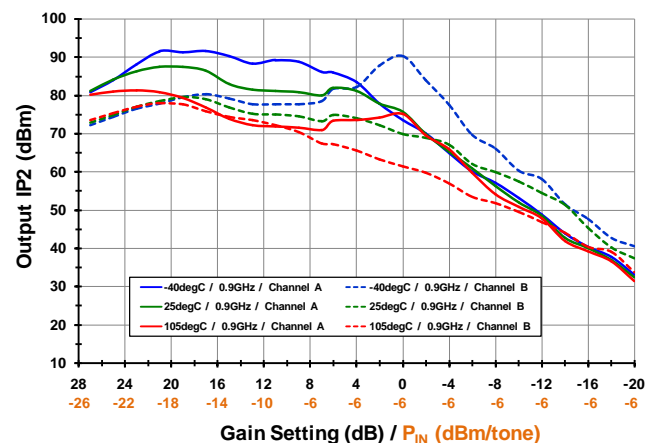

TOCs [SWEPT GAIN, STD MODE, IF = 276MHz, HS INJECTION] 2X2, 3X3, CURRENT, R-I, ISO (-10-)

2x2 Rejection [RF=0.7 GHz]

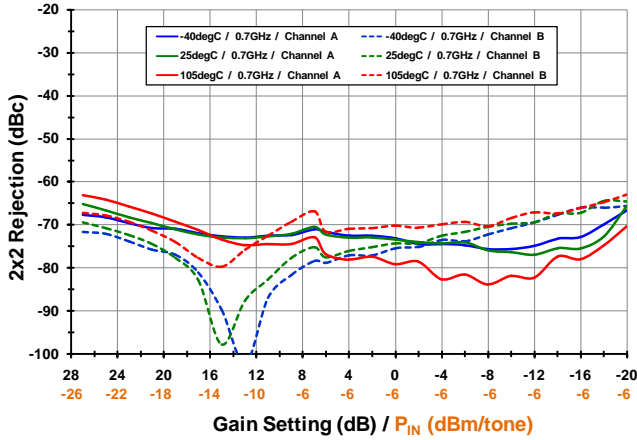

2x2 Rejection [RF=0.9 GHz]

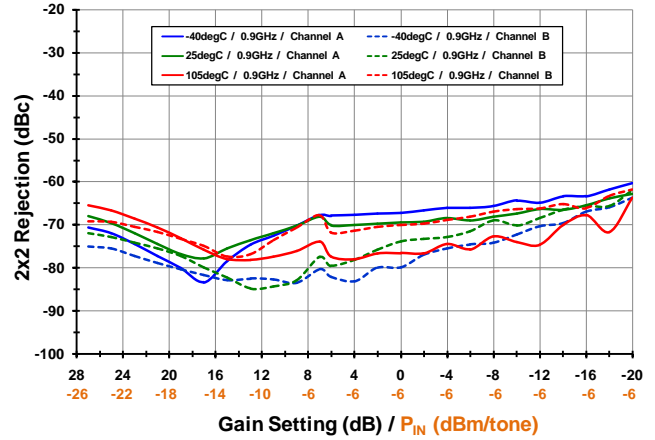

3x3 Rejection [RF=0.9 GHz]

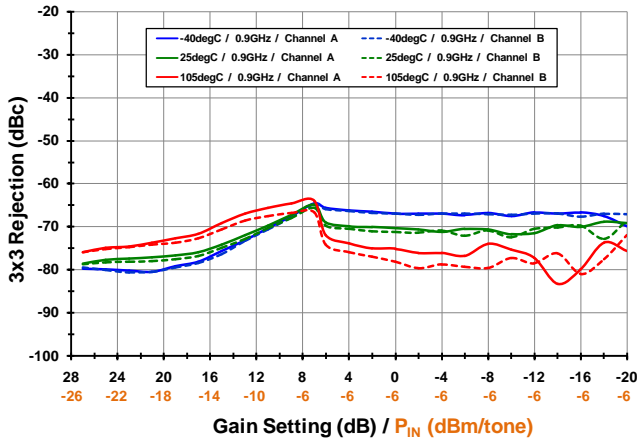

Total I<sub>CC</sub> [RF=0.9 GHz]

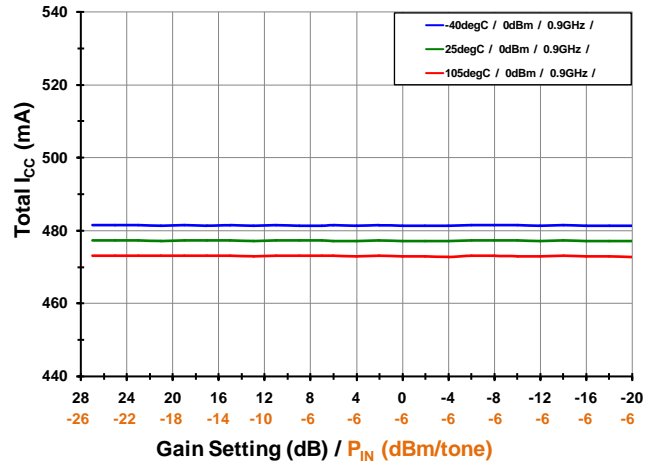

RF to IF Leakage [RF=0.9 GHz]

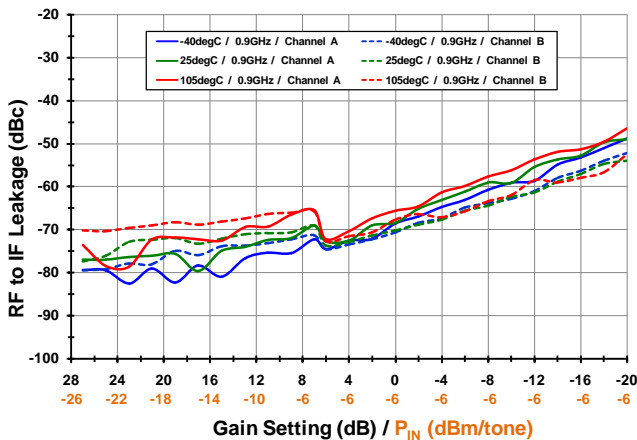

Channel Isolation [RF=0.9 GHz]

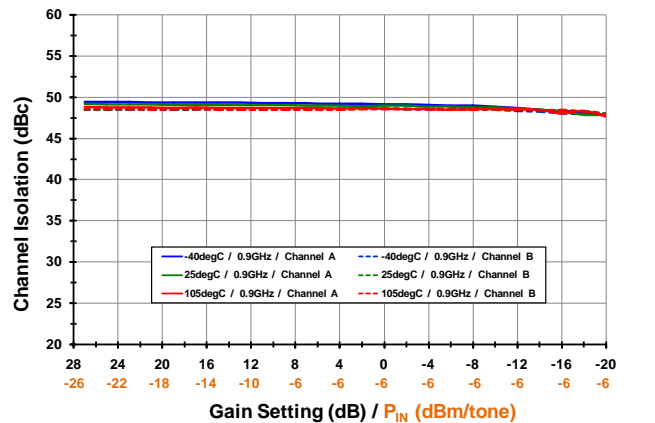

### TYPICAL OPERATING CONDITIONS (80 MHz IF CENTER)

Unless otherwise noted, the following conditions apply:

- Applications circuit for 100Ω differential load with 80MHz +/- 40MHz BW into 2:1 transformer. See schematic in BOM section.
- Pout ~ +3dBm
- Measurement on Channel A
- P<sub>IN</sub> from -27dBm to -5dBm per tone (Gain Setting Adjusted to yield Pout ~ +3dBm)
- Tone Spacing = 800KHz
- Device configured in Standard Mode with High Side Injection
- T<sub>CASE</sub> = 25C, V<sub>CC</sub> = 5.00V, LO Power = 0dBm
- RF Frequency: 915MHz
- IF Frequency: 80MHz
- IF Transformer Losses are de-embedded
- Input RF trace and connectors losses are de-embedded
- Listed Temperatures are Case Temperature (T<sub>C</sub> = Case Temperature)
- Where noted, T<sub>A</sub> or T<sub>AMB</sub> = Ambient Temperature

TOCs [SWEPT GAIN, STD MODE, IF = 80MHz, HS INJECTION] GAIN, OIP3, OIP2 (-11-)

RF Gain [RF=0.7 GHz]

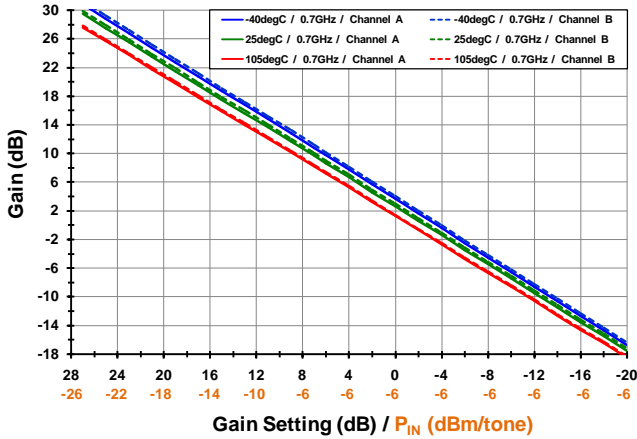

RF Gain [RF=0.9 GHz]

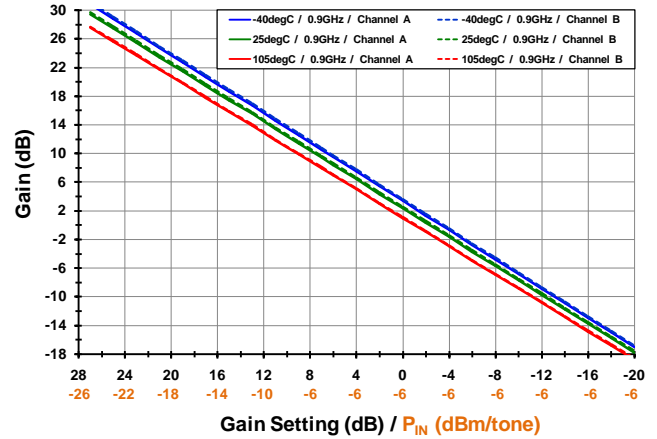

Output IP3 [RF=0.7 GHz]

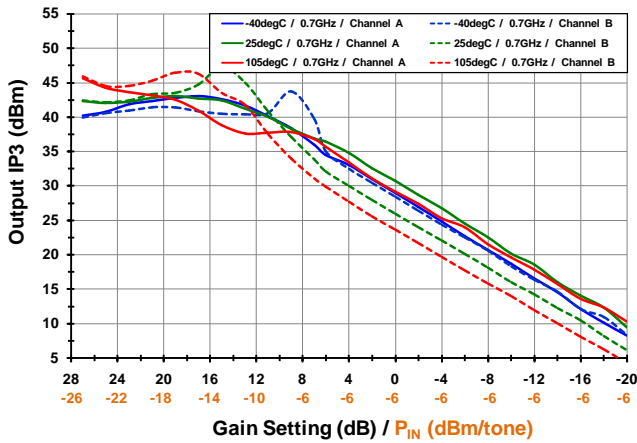

Output IP3 [RF=0.9 GHz]

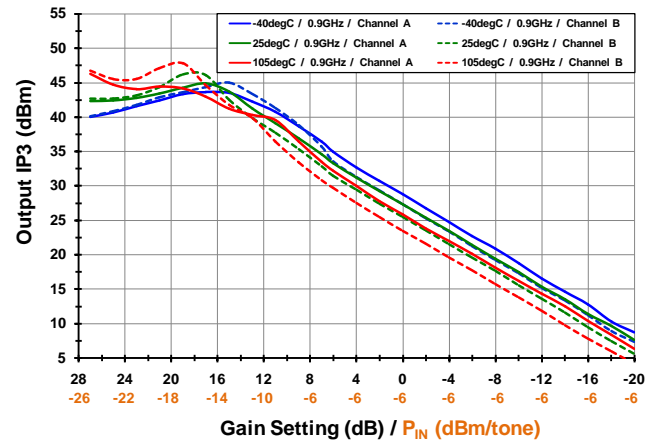

Output IP2 [RF=0.7 GHz]

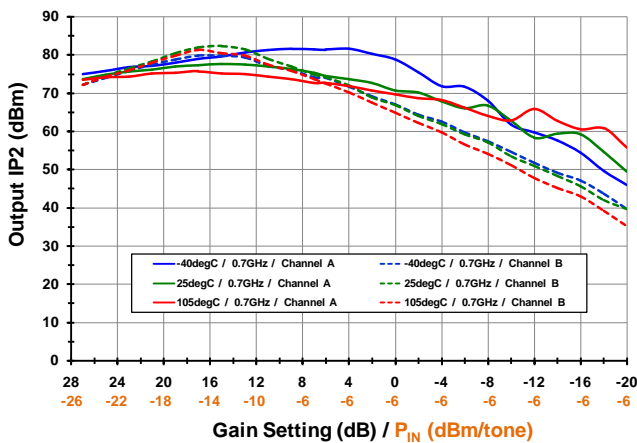

Output IP2 [RF=0.9 GHz]

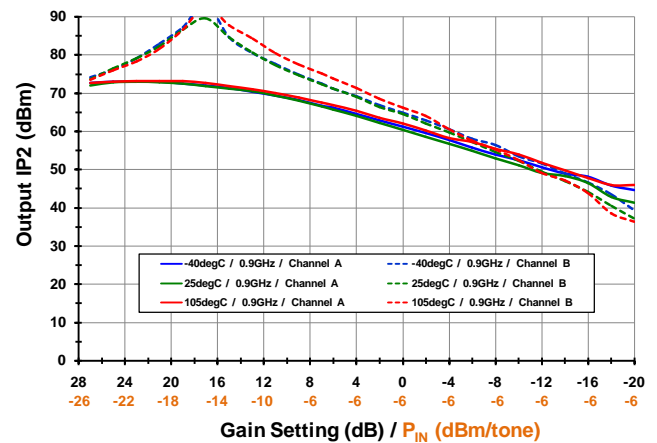

TOCs [SWEPT GAIN, STD MODE, IF = 80MHz, HS INJECTION] 2X2, 3X3, CURRENT, R-I, ISO (-12-)

2LO-2RF Rejection [RF=0.7 GHz]

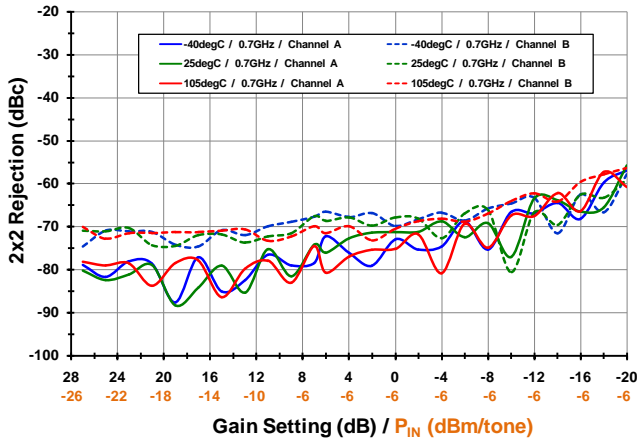

2LO-2RF Rejection [RF=0.9 GHz]

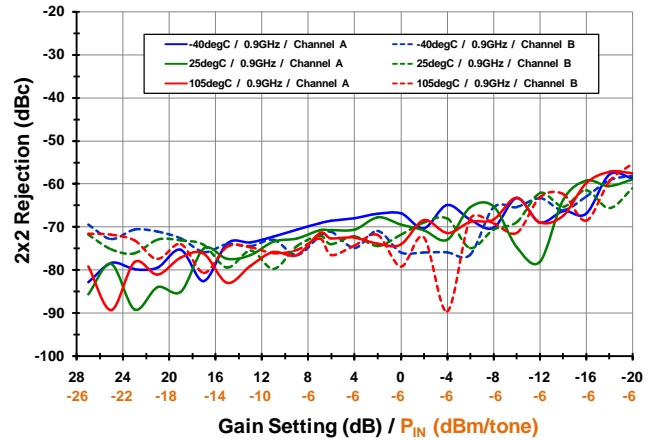

3LO-3RF Rejection [RF=0.9 GHz]

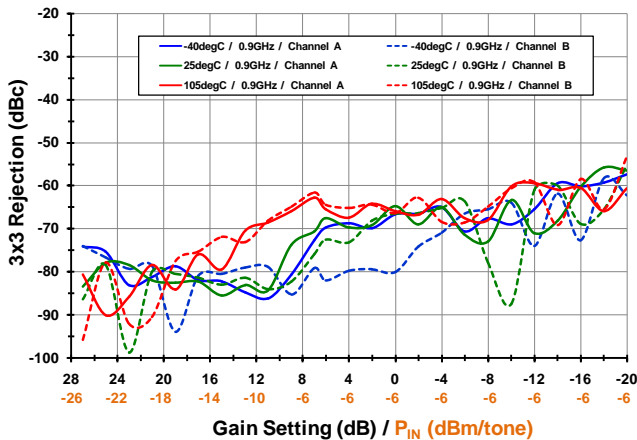

Total I<sub>CC</sub> [RF=0.9 GHz]

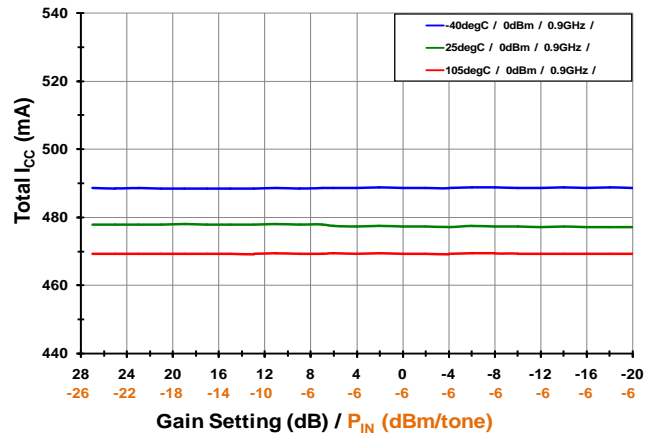

RF to IF Leakage [RF=0.9 GHz]

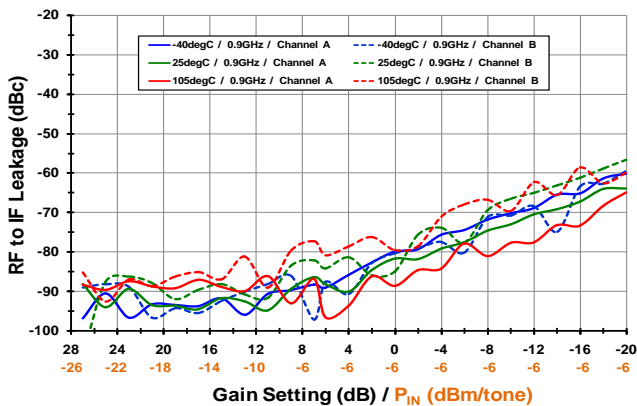

Channel Isolation [RF=0.9 GHz]

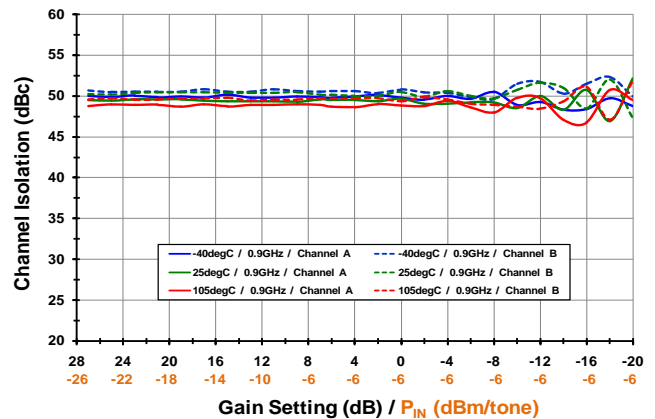

TOCs RETURN LOSS [STD MODE] (-13-)

IF\_A Output Return Loss 184MHz match

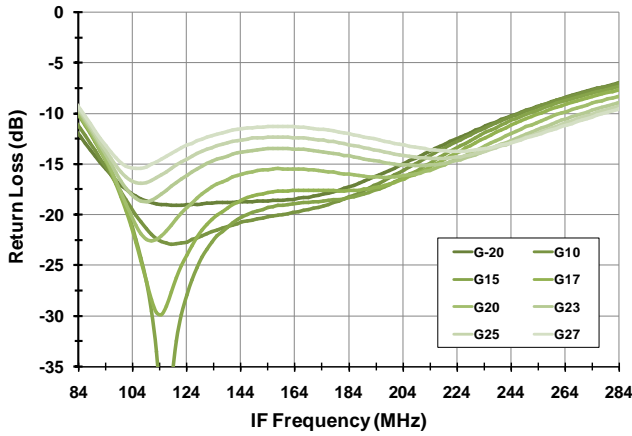

IF\_B Output Return Loss 184MHz match

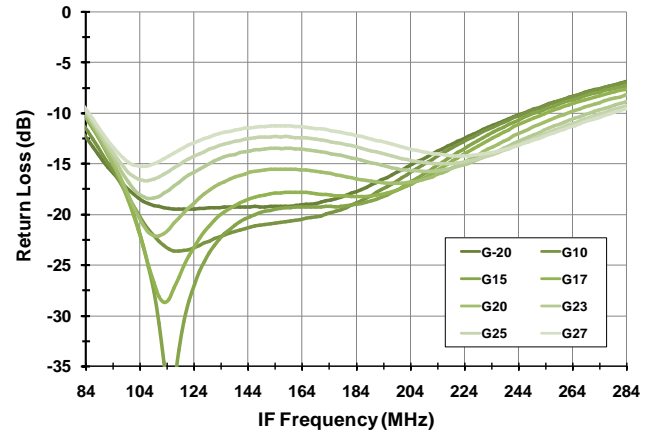

IF\_A Output Return Loss 276MHz match

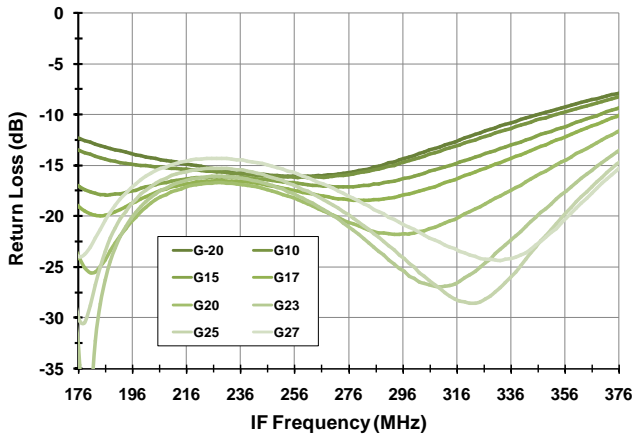

IF\_B Output Return Loss 276MHz match

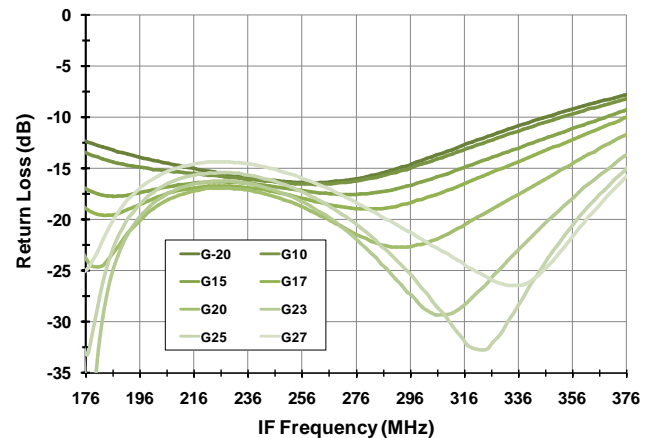

RF Port Return Loss

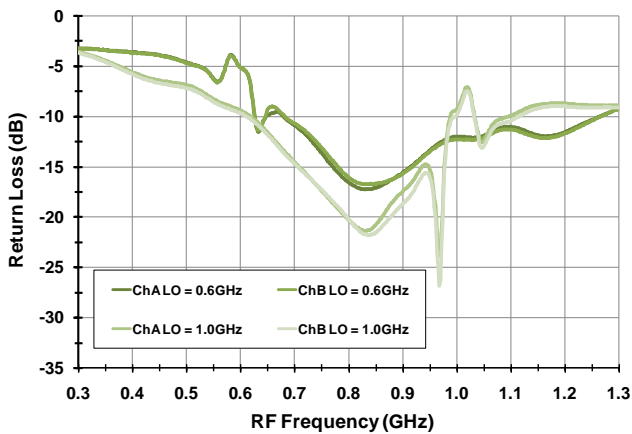

LO Port Return Loss

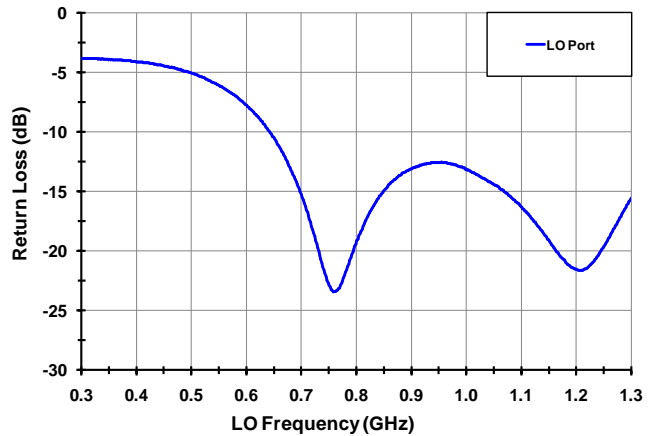



TOCS NOISE FIGURE, GAIN ACCURACY, P1dB [STD MODE] (-14-)

NF v Gain [RF=915M, IF=184M, HS Injection]

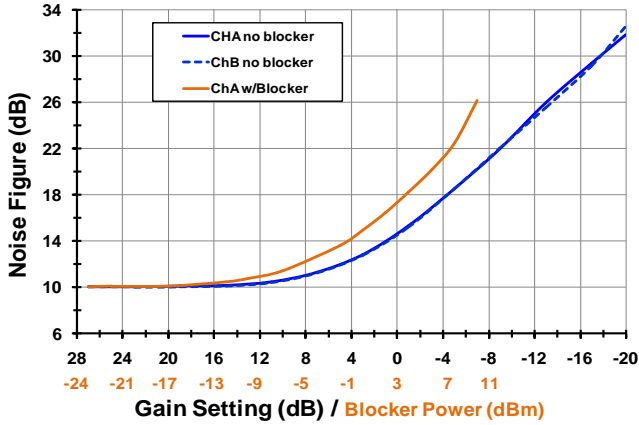

NF v Temp [RF=915M, IF=184M, HS Injection]

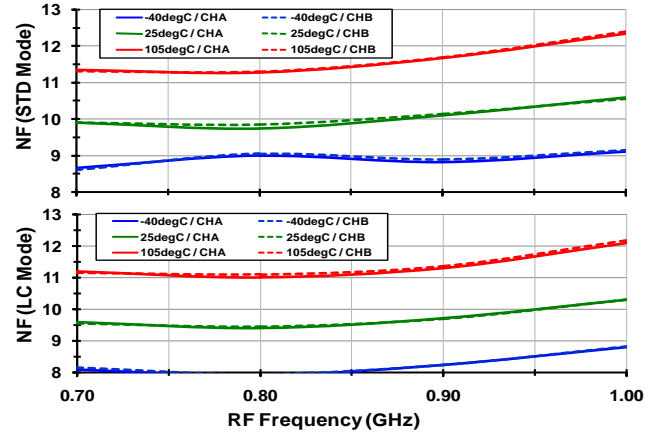

Gain Accuracy [RF = 915M, IF=184M, HS Injection]

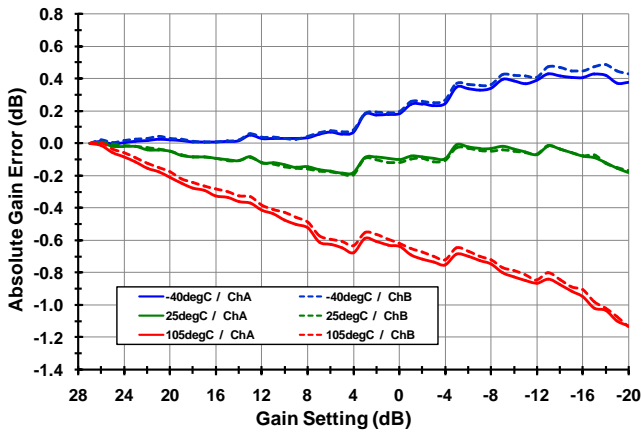

Output P1dB [IF = 184 MHz, High Side Injection]

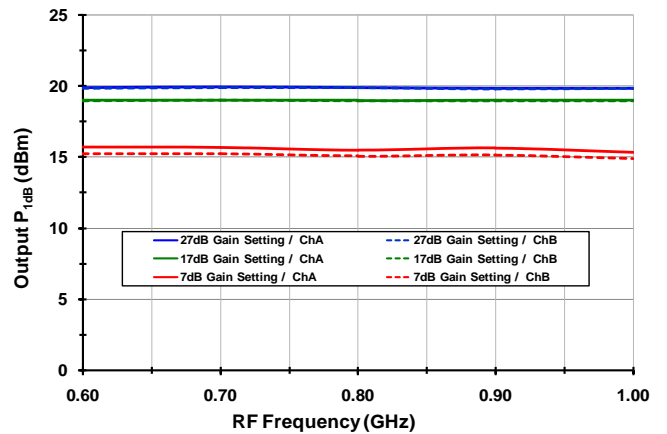

Input P1dB [IF = 184 MHz, High Side Injection]

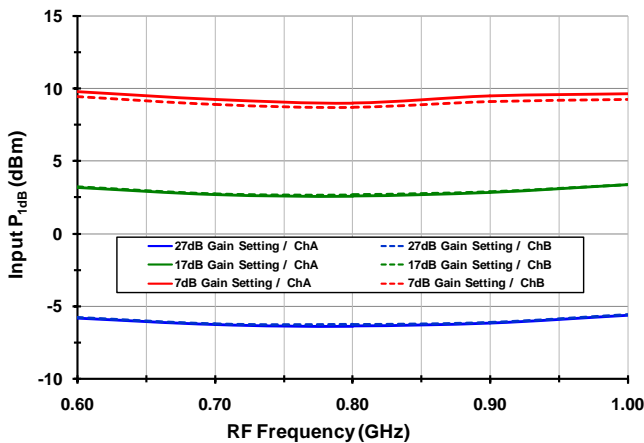

Input P1dB [RF = 915M, IF = 184M, High Side Inj.]

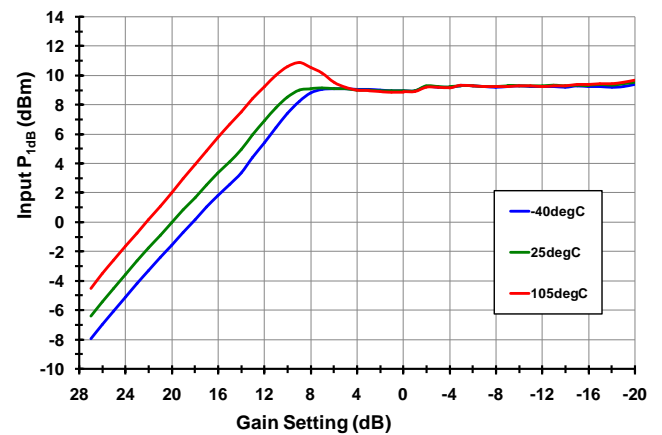

TOCs M x N SPURS [LO = 1.08182 GHz, T<sub>CASE</sub> = 25C, > -90 dBc] (-15-)

Spur Rejection [ChA, Spur P<sub>IN</sub> = -5 dBm]

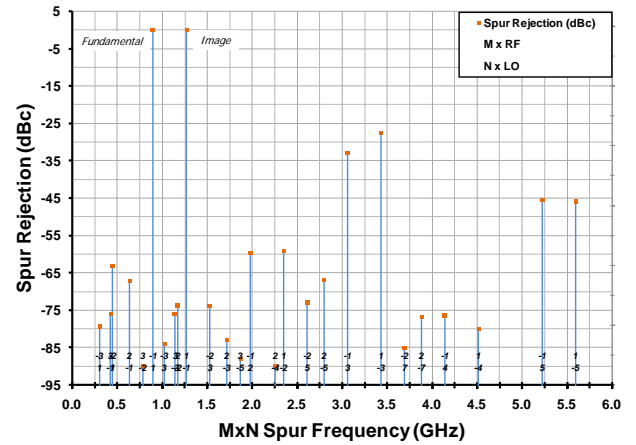
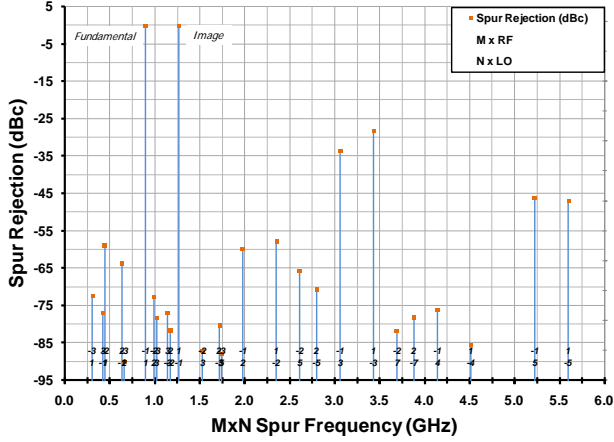

Spur Rejection [ChA, Spur P<sub>IN</sub> = 0 dBm]

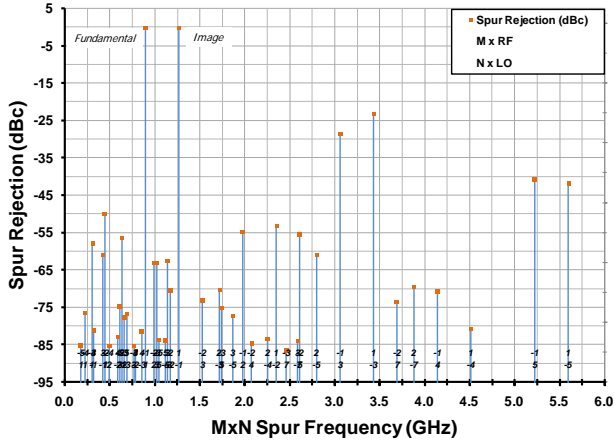

Spur Rejection [ChB, Spur P<sub>IN</sub> = 0 dBm]

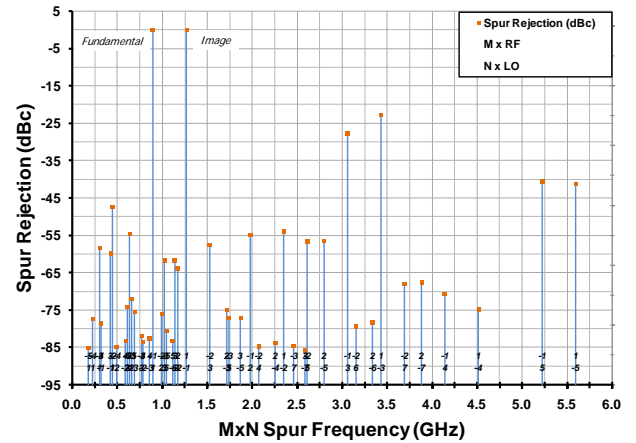

Transformer TC2-7T Loss vs. Temperature

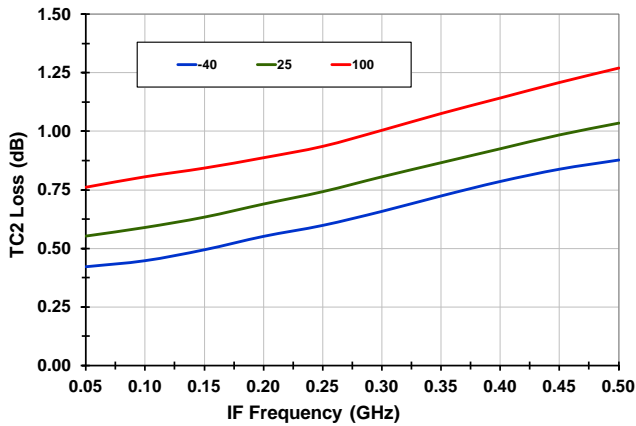

TOCS HISTOGRAMS [N= 4584, T<sub>CASE</sub> = 25C] (-16-)

Gain [RF = 850MHz, G<sub>MAX</sub>]

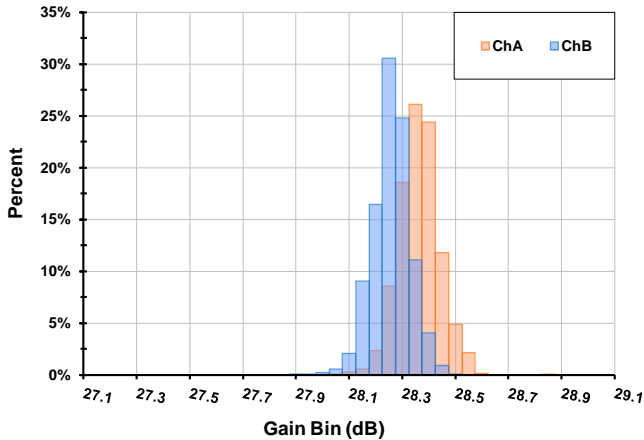

Output IP3 [RF = 850MHz, G<sub>MAX</sub>]

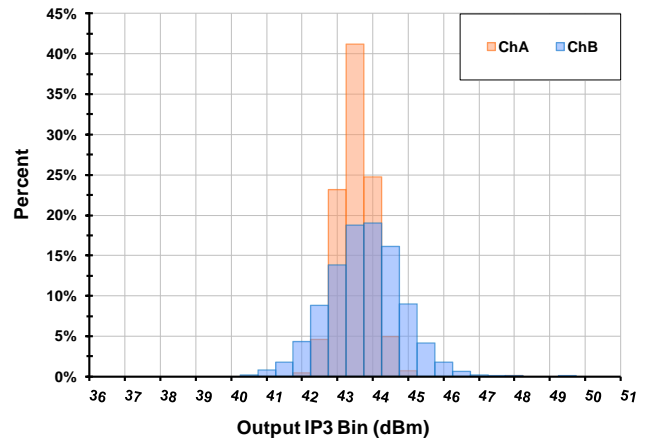

Output IP3 [RF = 850MHz, G<sub>17</sub>]

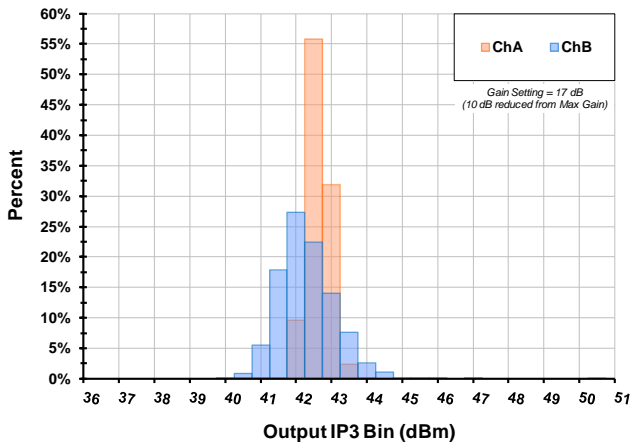

ATTN Accuracy1 [RF = 850MHz, ChB]

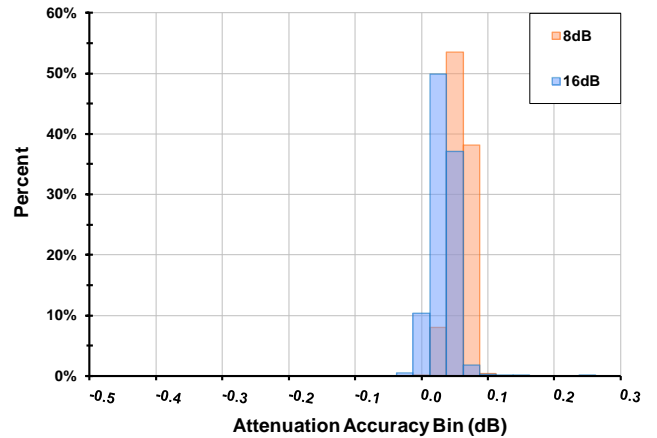

ATTN Accuracy2 [RF = 850MHz, ChB]

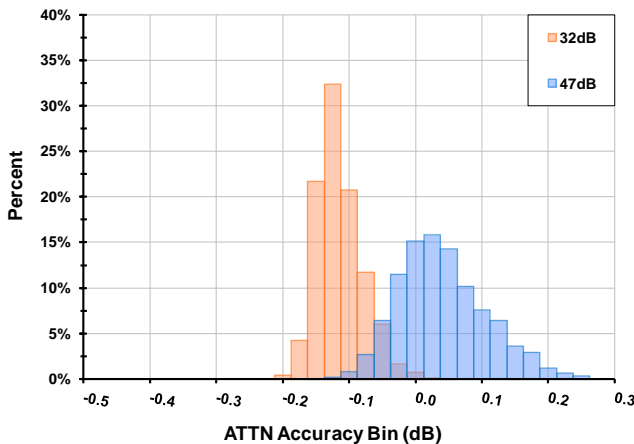

Total I<sub>CC</sub> [LO = 1034MHz, V<sub>CC</sub> = 5.00 V]

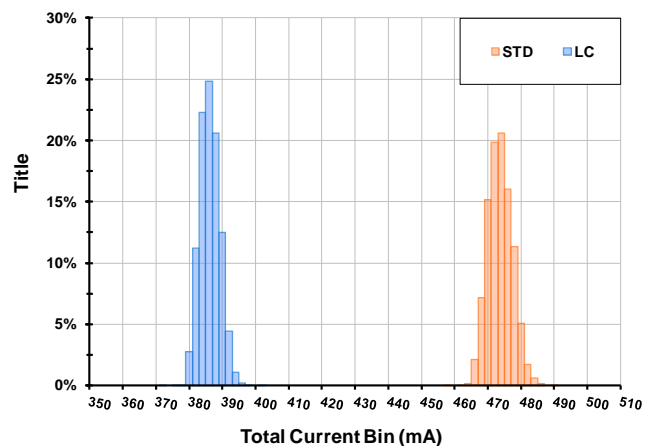

**PACKAGE OUTLINE DRAWINGS**

The package outline drawings are located at the end of this document and are accessible from the Renesas website (see Ordering Information for POD links). The package information is the most current data available and is subject to change without revision of this document.

**PIN DIAGRAM**

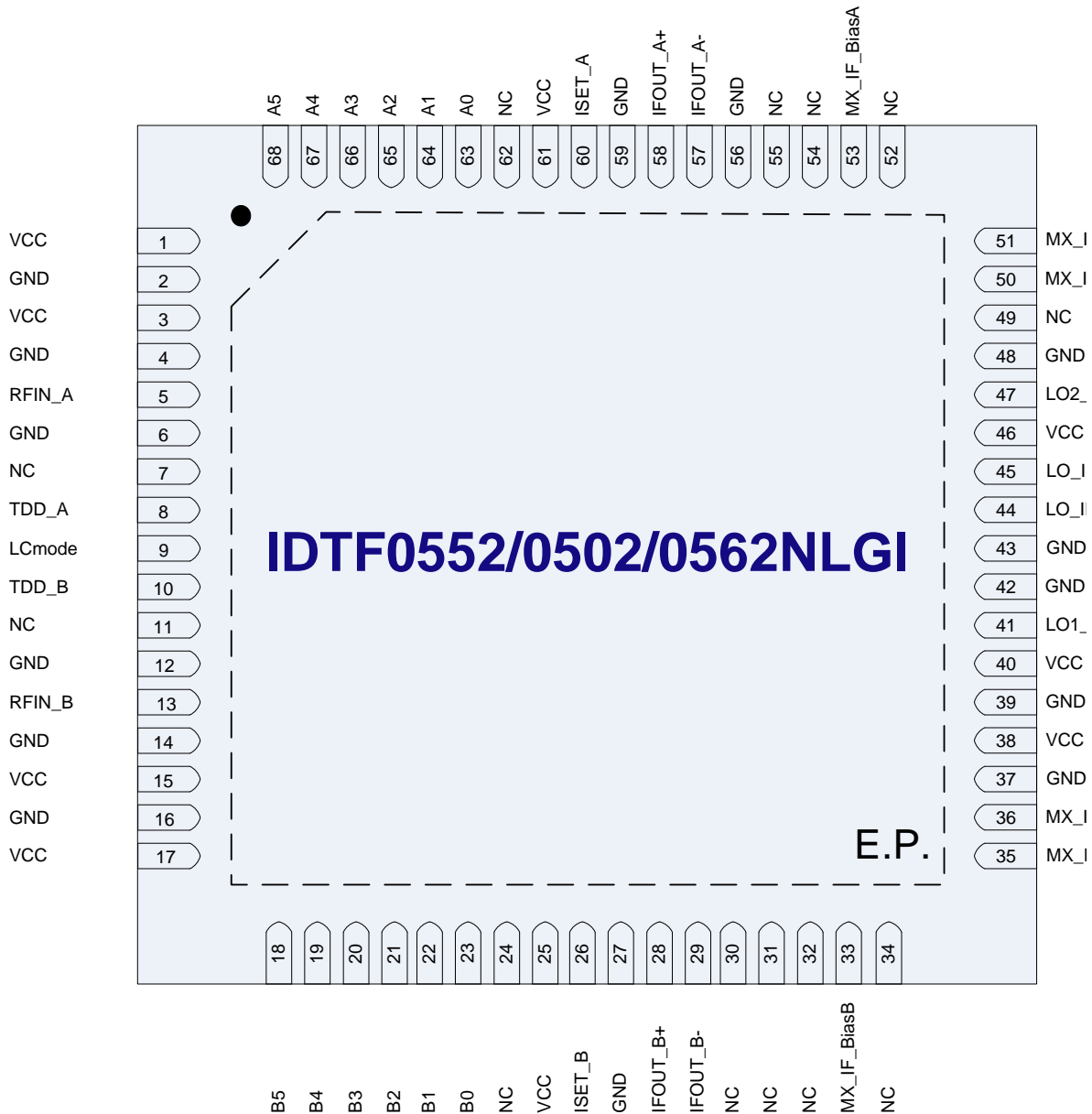

**PIN DESCRIPTION**

Pin	Name	Function
1, 3, 15, 17, 25, 38, 40, 46, 61	VCC	Power Supply. Bypass to GND with capacitors shown in the Typical Application Circuit as close as possible to pin.
2, 4, 6, 12, 14, 16, 27, 37, 39, 42, 43, 48, 56, 59	GND	Ground these pins. These pins are internally tied to the exposed paddle.
5	RFIN_A	Main Channel RF Input. Internally matched to 50Ω. <b>DO NOT apply DC to this pin,</b>
7, 11, 24, 30, 31, 32, 34, 49, 52, 54, 55, 62	NC	No Connection. Not internally connected. OK to connect to VCC, or GND
8	TDD_A	Standby control for Channel A. Includes an internal pull-up resistor so leave as NC for Standby mode. Set this pin to low or GND for normal operation.
9	LCmode	Low_Current Mode. Includes an internal pull-up resistor so leave as NC for LC mode. Set this pin to low or GND for STD mode.
10	TDD_B	Standby control for Channel B. Includes an internal pull-up resistor so leave as NC for Standby mode. Set this pin to low or GND for normal operation.
13	RFIN_B	Diversity Channel RF Input. Internally matched to 50Ω. <b>DO NOT apply DC to this pin,</b>
18	B5	Parallel Gain Control Input - MSB
19	B4	Parallel Gain Control Input
20	B3	Parallel Gain Control Input
21	B2	Parallel Gain Control Input
22	B1	Parallel Gain Control Input
23	B0	Parallel Gain Control Input – LSB (1 dB step)
26	ISET_B	ChB VGA Icc set: Recommended resistor value = 3.48kΩ
28	IFOUT_B+	Channel B Differential Output +. Pull up to Vcc through an inductor
29	IFOUT_B-	Channel B Differential Output -. Pull up to Vcc through an inductor
33	MX_IF_BiasB	Connect the specified resistor for either Standard mode (40.2Ω) or LC mode (62Ω) from this pin to ground to set the bias for the Diversity IF amplifier. This is NOT a current set resistor.
35	MX_IFB+	Diversity Mixer Differential IF (+) Output. Connect a pullup inductor from this pin to VCC.
36	MX_IFB-	Diversity Mixer Differential IF (-) Output. Connect a pullup inductor from this pin to VCC.

**PIN DESCRIPTION (CONTINUED)**

41	LO1_ADJ	Connect the specified resistor for either Standard mode (91Ω ) or LC mode (180Ω ) from this pin to ground to set the LO common buffer Icc.
44	LO_IN	Local Oscillator Input. Connect the LO to this port through the recommended coupling capacitor.
45	LO_IN_RTN	Transformer ground return. Ground this pin close to the device
47	LO2_ADJ	Connect the specified resistor for either Standard mode (1.21kΩ) or LC mode (1.91kΩ) from this pin to ground to set the LO drive buffers Icc.
50	MX_IFA-	Diversity Mixer Differential IF (-) Output. Connect a pullup inductor from this pin to VCC.
51	MX_IFA+	Diversity Mixer Differential IF (+) Output. Connect a pullup inductor from this pin to VCC.
53	MX_IF_BiasA	Connect the specified resistor for either Standard mode (40.2Ω ) or LC mode (62Ω) from this pin to ground to set the bias for the Diversity IF amplifier. This is NOT a current set resistor.
57	IFOUT_A-	Channel A Differential Output -. Pull up to Vcc through an inductor
58	IFOUT_A+	Channel A Differential Output +. Pull up to Vcc through an inductor
60	ISET_A	ChA VGA Icc set: Recommended resistor value = 3.48kΩ
63	A0	Parallel Gain Control Input – LSB (1dB step)
64	A1	Parallel Gain Control Input
65	A2	Parallel Gain Control Input
66	A3	Parallel Gain Control Input
67	A4	Parallel Gain Control Input
68	A5	Parallel Gain Control Input - MSB
69	EP	Exposed Pad. Internally connected to GND. Solder this exposed pad to a PCB pad that uses multiple ground vias to provide heat transfer out of the device into the PCB ground planes. These multiple via grounds are also required to achieve the noted RF performance.

### DIGITAL PIN VOLTAGE AND RESISTANCE VALUES

The following table provides open-circuit DC voltage referenced to ground and resistance values for each of the control pins listed.

Pin	Name	DC Voltage (volts)	Resistance (ohms)
8	TDD_A	5V	50kΩ to Vcc
9	LCmode	5V	50kΩ to Vcc
10	TDD_B	5V	50kΩ to Vcc
18 – 23	B5-B0	5V	50kΩ to Vcc
63 - 68	A0-A5	5V	50kΩ to Vcc

## APPLICATIONS INFORMATION

### Power Supplies

A common VCC power supply should be used for all pins requiring DC power. All supply pins should be bypassed with external capacitors to minimize noise and fast transients. Supply noise can degrade noise figure and fast transients can trigger ESD clamps and cause them to fail. Supply voltage change or transients should have a slew rate smaller than  $1V/20\mu s$ . In addition, all control pins should remain at 0V (+/-0.3V) while the supply voltage ramps or while it returns to zero.

### Control Pin Interface

If control signal integrity is a concern and clean signals cannot be guaranteed due to overshoot, undershoot, ringing, etc., provisions for an R-C circuit at the input of each control and data pin is recommended. This applies to pins 8, 9, 10, 18 - 23, and 63 - 68 as shown below.

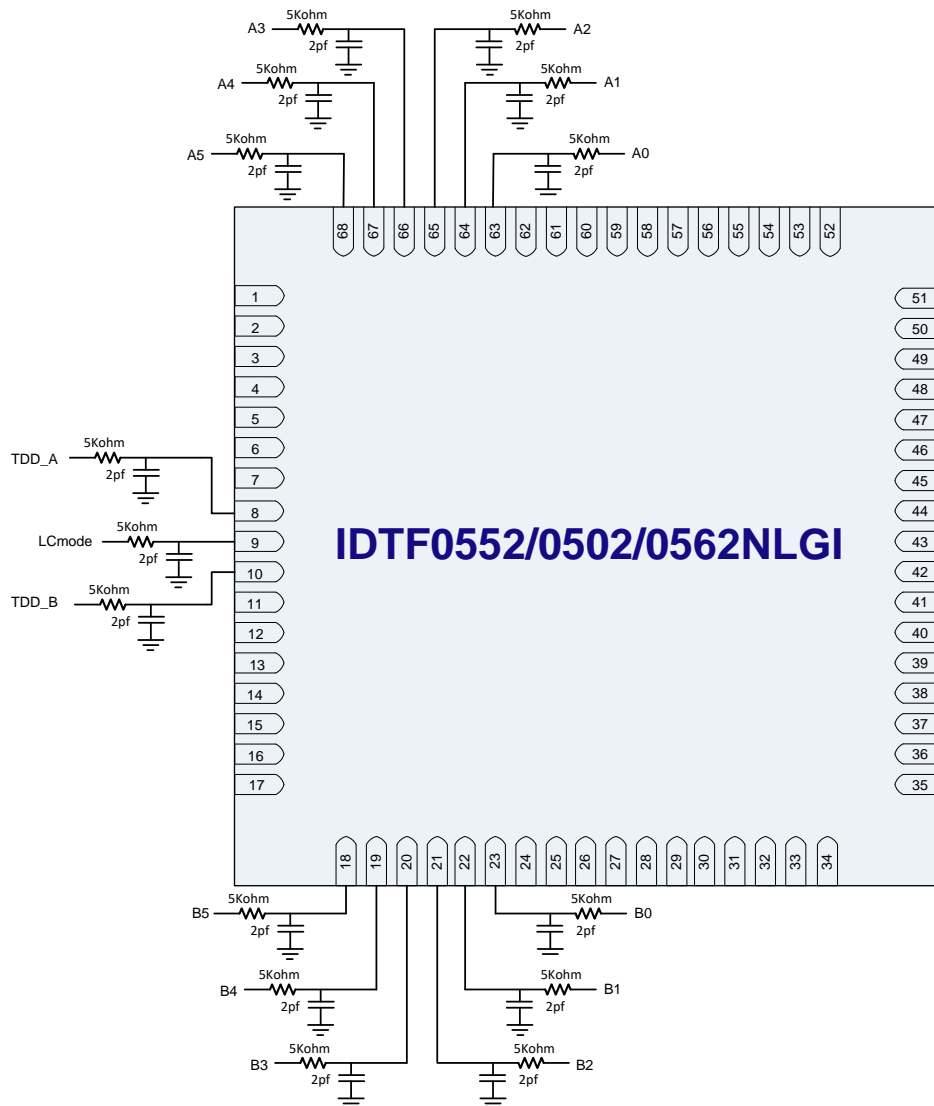



**EVKIT AND TYPICAL APPLICATION SCHEMATIC**

The following schematic describes the recommended EVkit and applications circuit.

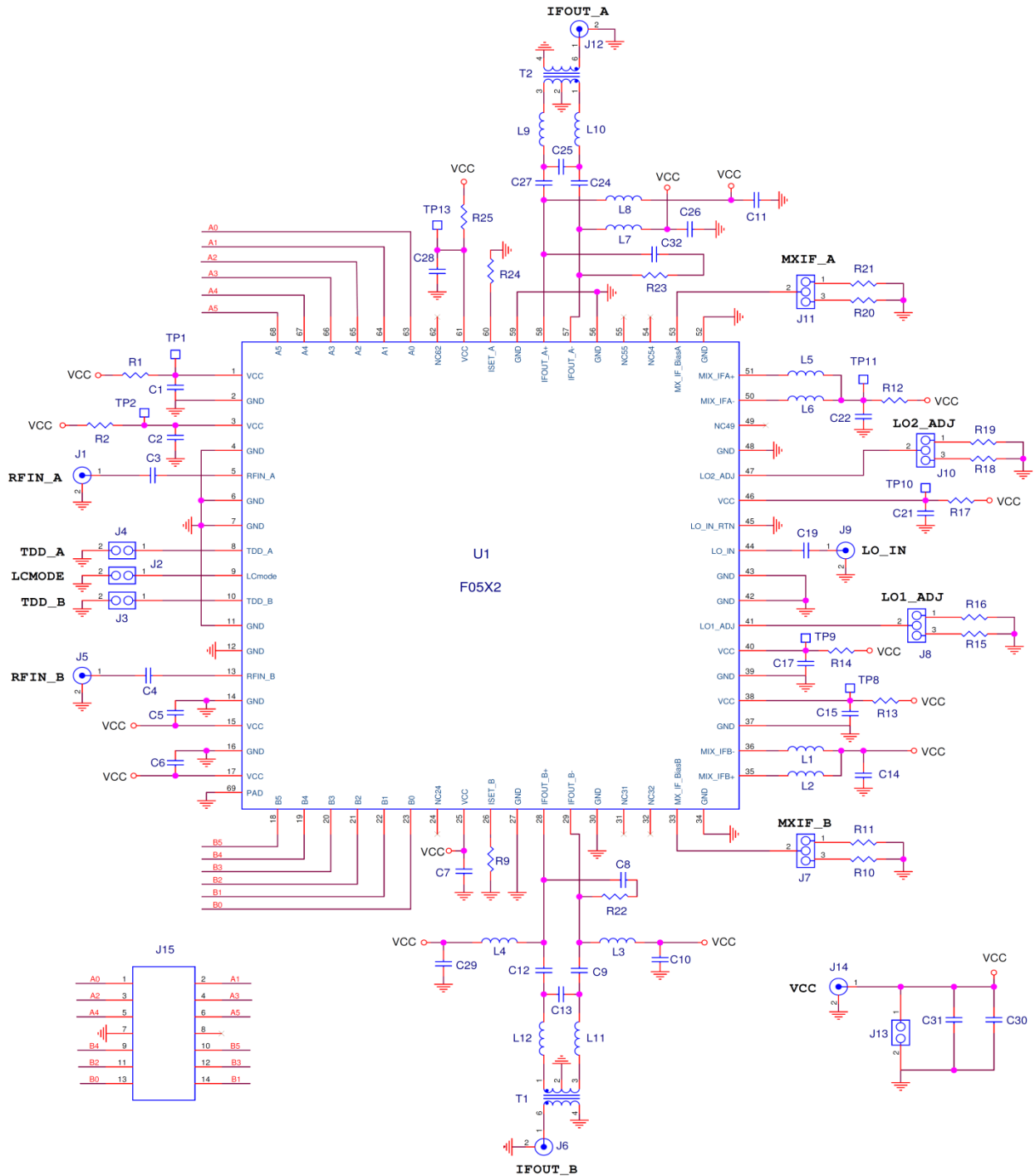

EVKIT PICTURE

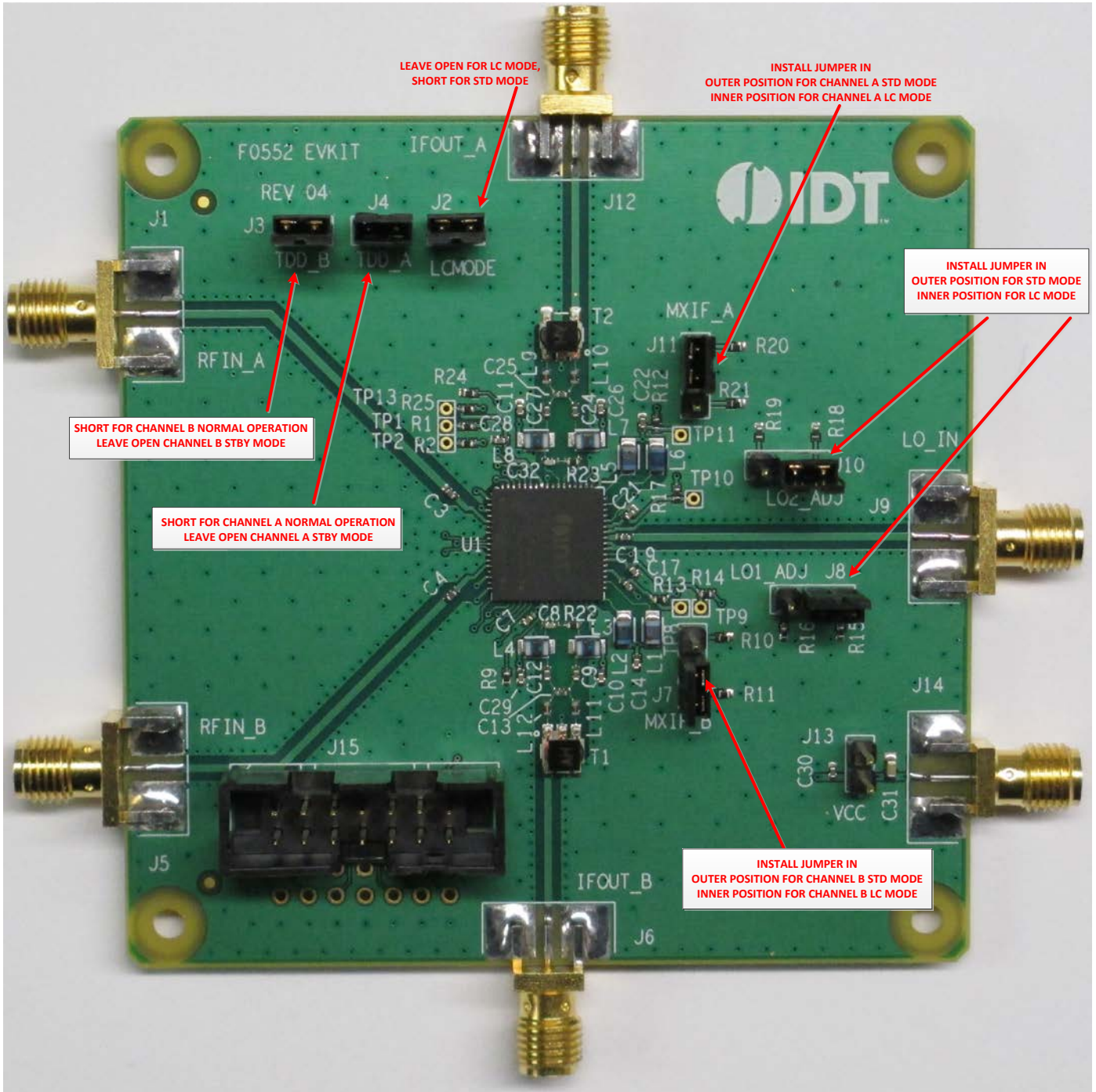

## BOM 1 AND 2

Two BOMs are included: BOM1 supports the 4:1 output transformation from 200Ω to 50Ω used for production test and BOM2 supports the 2:1 output transformation from 200Ω to 100Ω used to generate the typical operating curve graphs.

- For Standard (STD) Mode, use resistor values in **RED** and short J2 LCMODE jumper (short pin to GND).
- For Low Current (LC) Mode, use resistor values in **BLUE** and open J2 LCMODE jumper (open pin).

**BOM1** includes components for 4:1 output transformation supporting production test (IF center frequency 184MHz)

4:1 Transformer, IF = 184MHz 8/13/14

Part Reference	QTY	DESCRIPTION	Mfr. Part #	Mfr.
C3, 4, 19	3	CAP CER 39PF ±5% 50V C0G (0402)	GRM1555C1H390JZ010	Murata
C9, 12, 24, 27	4	CAP CER 1000PF ±5% 50V C0G (0402)	GRM1555C1H102JA01D	Murata
C1, 2, 5, 6, 7, 10, 11, 14, 15, 17, 21, 22, 26, 28, 29, 30	16	CAP CER 10NF ±10% 16V X7R (0402)	GRM155R71C103KA01D	Murata
C31	1	CAP CER 10UF ±20% 6.3V X5R (0603)	GRM188R60J106ME47D	Murata
C8, 32	2	CAP CER 0.6PF ±0.1PF 50V C0G (0402)	GRM1555C1HR60B	Murata
<b>R15</b>	1	RES 91.0 OHM ±1% 1/10W (0402)	ERJ-2RKF91R0X	Panasonic
<b>R16</b>	1	RES 180 OHM ±1% 1/10W (0402)	ERJ-2RKF1800X	Panasonic
<b>R18</b>	1	RES 1.21K OHM ±1% 1/10W (0402)	ERJ-2RKF1211X	Panasonic
<b>R19</b>	1	RES 1.91K OHM ±1% 1/10W (0402)	ERJ-2RKF1911X	Panasonic
<b>R10, 21</b>	2	RES 62.0 OHM ±1% 1/10W (0402)	ERJ-2RKF62R0X	Panasonic
R9, 24	2	RES 3.48K OHM ±1% 1/10W (0402)	ERJ-2RKF3481X	Panasonic
<b>R11, 20</b>	2	RES 40.2 OHM ±1% 1/10W (0402)	ERJ-2RKF40R2X	Panasonic
R22, 23	2	RES 100 OHM ±1% 1/10W (0402)	ERJ-2RKF1000X	Panasonic
R1, 2, 12, 13, 14, 17, 25, L9-L12	11	RES 0.0 OHM 1/10W (0402)	ERJ-2GE0R00X	Panasonic
L1-8	8	IND 390nH ±5% 0805CS (2012)	0805CS-391XJLB	Coilcraft
J6, 12, 14	3	SMA END LAUNCH (Big)	142-0701-851	Emerson Johnson
J1, 5, 9	3	SMA END LAUNCH (small)	142-0711-821	Emerson Johnson
J15	1	CONN HEADER VERT SGL 7 x 2 POS GOLD	N2514-6002-RB	3M
<b>J2, 3, 4, 13</b>	4	CONN HEADER VERT SGL 2 x 1 POS GOLD	961102-6404-AR	3M
J7, 8, 10, 11	4	CONN HEADER VERT SGL 3 x 1 POS GOLD	961103-6404-AR	3M
T1, 2	2	4:1 Center Tap Balun (SM-22)	TC4-1WG2+	Mini Circuits
U1	1	Sampling IF receiver (TQFN-68)	F0502	IDT
C13, 25		Not Installed CER CAP (0402)		
	1	Printed Circuit Board	F0502 EVKit Rev 04	

**BOM2** includes components for 2:1 output transformation used for TOCs (IF center frequency 184MHz +/- 40MHz)

**2:1 Transformer, IF = 184MHz 8/13/14**

Part Reference	QTY	DESCRIPTION	Mfr. Part #	Mfr.
C3, 4, 19	3	CAP CER 150PF ±5% 50V C0G (0402)	GRM1555C1H151JA01D	Murata
C9,12, 24, 27	4	CAP CER 20PF ±5% 50V C0G (0402)	GRM1555C1H200JZ01D	Murata
C1, 2, 5, 6, 7, 10, 11, 14,15, 17, 21, 22, 26, 28, 29, 30	16	CAP CER 10NF ±10%16V X7R (0402)	GRM155R71C103KA01D	Murata
C31	1	CAP CER 10UF ±20% 6.3V X5R (0603)	GRM188R60J106ME47D	Murata
C13, 25	2	CAP CER 3PF ±0.25PF 50V C0G (0402)	GRM1555C1H3R0CZ01D	Murata
C8, 32	2	CAP CER 0.6PF ±0.1pF 50V C0G (0402)	GRM1555C1HR60BB01D	Murata
R15	1	RES 91.0 OHM ±1% 1/10W (0402)	ERJ-2RKF91R0X	Panasonic
R16	1	RES 180 OHM ±1% 1/10W (0402)	ERJ-2RKF1800X	Panasonic
R18	1	RES 1.21K OHM ±1% 1/10W (0402)	ERJ-2RKF1211X	Panasonic
R19	1	RES 1.91K OHM ±1% 1/10W (0402)	ERJ-2RKF1911X	Panasonic
R10, 21	2	RES 62.0 OHM ±1% 1/10W (0402)	ERJ-2RKF62R0X	Panasonic
R9, 24	2	RES 3.48K OHM ±1% 1/10W (0402)	ERJ-2RKF3481X	Panasonic
R11, 20	2	RES 40.2 OHM ±1% 1/10W (0402)	ERJ-2RKF40R2X	Panasonic
R22, 23	2	RES 100 OHM ±1% 1/10W (0402)	ERJ-2RKF1000X	Panasonic
R1, 2, 12, 13, 14, 17, 25	7	RES 0.0 OHM 1/10W (0402)	ERJ-2GE0R00X	Panasonic
L1, 2, 5, 6	4	IND 390nH ±5% 0805CS (2012)	0805CS-391XJLB	Coilcraft
L3, 4, 7, 8	4	IND 150nH ±5% 0805CS (2012)	0805CS-151XJLB	Coilcraft
L9-12	4	IND 30nH ±5% 0402CS	0402CS-30NXJLU	Coilcraft
J1, 5, 9	3	SMA END LAUNCH (Big)	142-0701-851	Emerson Johnson
J6,12,14	3	SMA END LAUNCH (small)	142-0711-821	Emerson Johnson
J15	1	CONN HEADER VERT SGL 7 x 2 POS GOLD	N2514-6002-RB	3M
J2, 3, 4, 13	4	CONN HEADER VERT SGL 2 x 1 POS GOLD	961102-6404-AR	3M
J7, 8, 10, 11	4	CONN HEADER VERT SGL 3 x 1 POS GOLD	961103-6404-AR	3M
T1, 2	2	2:1 Center Tap Balun (SM-22)	TC2-72T+	Mini Circuits
U1	1	Sampling IF receiver (TQFN -68)	F0502	IDT
	1	Printed Circuit Board	F0502EV Kit Rev 04	

## IF BIAS AND OUTPUT MATCHING CIRCUIT AND BOM FOR VARIOUS IFs

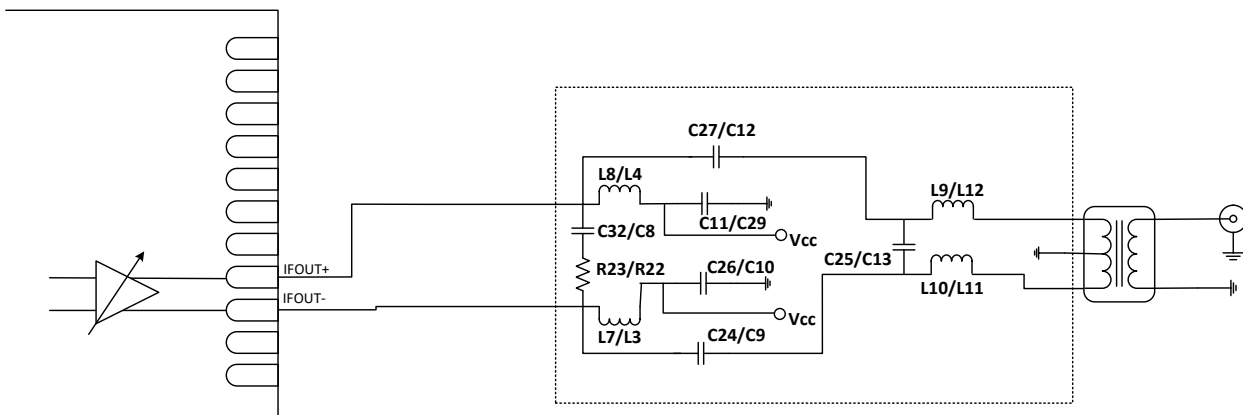

**IF NETWORK BOM FOR DIFFERENT FREQUENCIES**

Item #	Part Reference	Value				Unit
		IF frequency				
		80 (60-100)	138, 184 (98-240)	276 (190-316)	330 (250-410)	MHz
1	C9, 12, 24, 27	75	20	8	6	pF
2	C13,25	11	3	1.2	0.7	pF
3	C8, C32	0.6	0.6	0.6	0.6	pF
4	R22, R23	100	100	100	100	ohm
5	L3, 4, 7, 8	220	150	82	56	nH
6	L9-12	36	30	24	18	nH

**TOP MARKING**

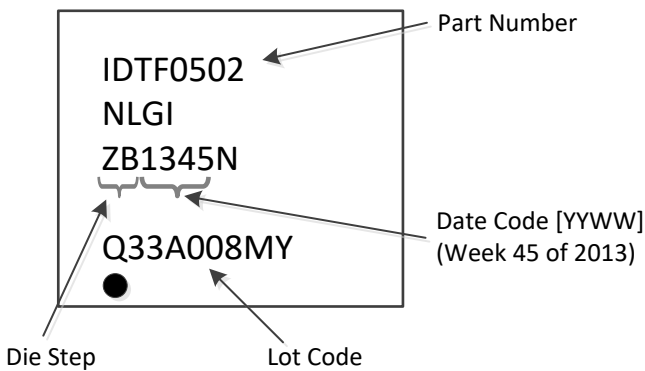

**ORDERING INFORMATION**

Part Number	Package Description	Carrier Type	Temperature Range
F0502NLGI	<a href="#">68-VFQFPN</a> , 10 × 10 mm	Tape and Reel	-40°C to +85°C
F0502NLGI8		Tray	

**REVISION HISTORY**

Revision Date	Description
February 8, 2022	Rebranded to Renesas.
July 20, 2016	Initial release.

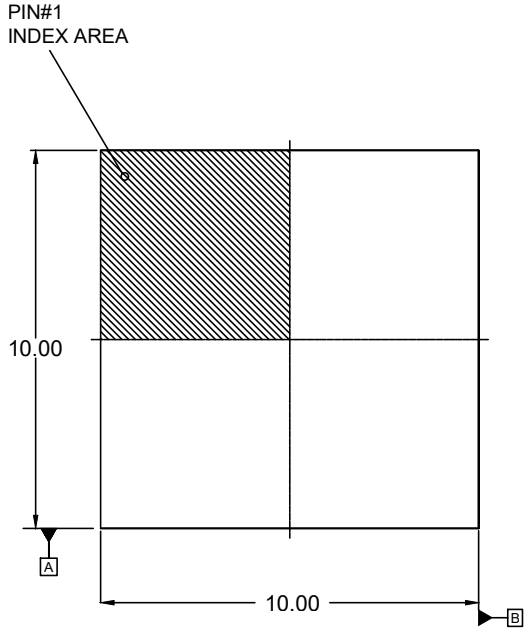

TOP VIEW

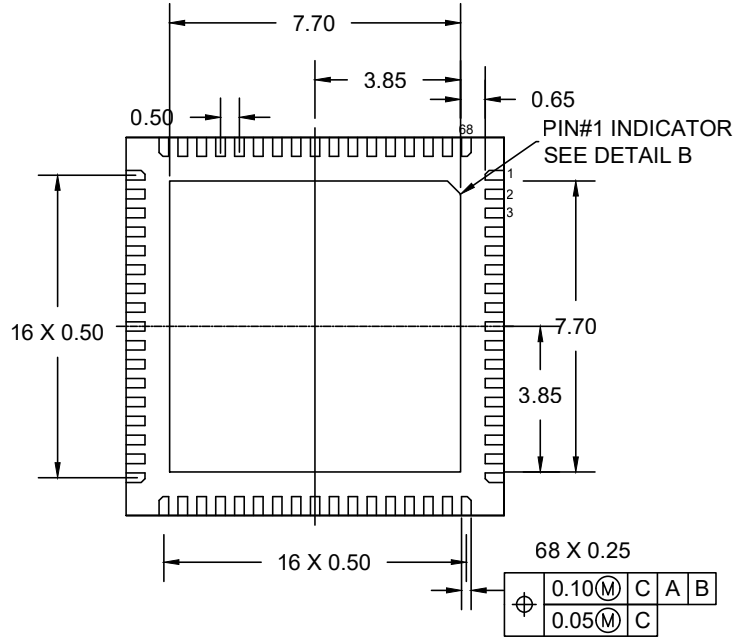

BOTTOM VIEW

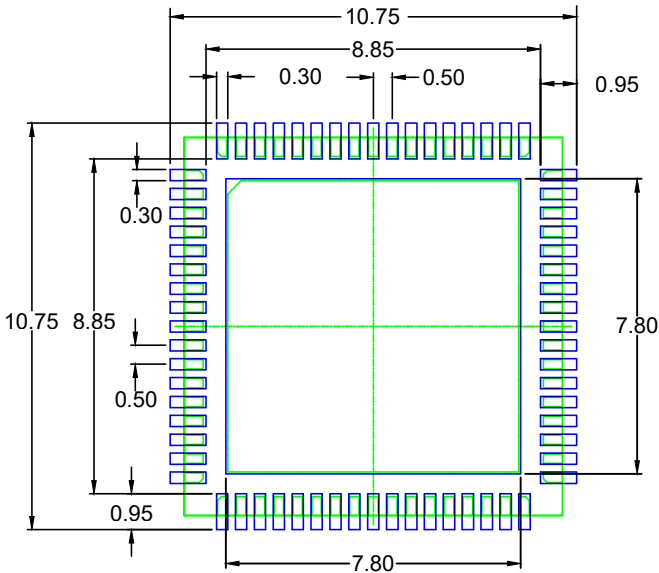

RECOMMENDED LAND PATTERN DIMENSION

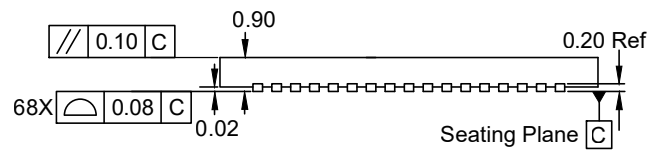

SIDE VIEW

NOTES:

1. All dimension are in mm, angles in degrees.
2. Top down view, as viewed on PC.
3. Land pattern in blue. NSMD land pattern assumed.
4. Land pattern recommendation as per IPC-7351B generic requirement for surface mount design and land pattern.

## IMPORTANT NOTICE AND DISCLAIMER

RENESAS ELECTRONICS CORPORATION AND ITS SUBSIDIARIES (“RENESAS”) PROVIDES TECHNICAL SPECIFICATIONS AND RELIABILITY DATA (INCLUDING DATASHEETS), DESIGN RESOURCES (INCLUDING REFERENCE DESIGNS), APPLICATION OR OTHER DESIGN ADVICE, WEB TOOLS, SAFETY INFORMATION, AND OTHER RESOURCES “AS IS” AND WITH ALL FAULTS, AND DISCLAIMS ALL WARRANTIES, EXPRESS OR IMPLIED, INCLUDING, WITHOUT LIMITATION, ANY IMPLIED WARRANTIES OF MERCHANTABILITY, FITNESS FOR A PARTICULAR PURPOSE, OR NON-INFRINGEMENT OF THIRD PARTY INTELLECTUAL PROPERTY RIGHTS.

These resources are intended for developers skilled in the art designing with Renesas products. You are solely responsible for (1) selecting the appropriate products for your application, (2) designing, validating, and testing your application, and (3) ensuring your application meets applicable standards, and any other safety, security, or other requirements. These resources are subject to change without notice. Renesas grants you permission to use these resources only for development of an application that uses Renesas products. Other reproduction or use of these resources is strictly prohibited. No license is granted to any other Renesas intellectual property or to any third party intellectual property. Renesas disclaims responsibility for, and you will fully indemnify Renesas and its representatives against, any claims, damages, costs, losses, or liabilities arising out of your use of these resources. Renesas' products are provided only subject to Renesas' Terms and Conditions of Sale or other applicable terms agreed to in writing. No use of any Renesas resources expands or otherwise alters any applicable warranties or warranty disclaimers for these products.

(Rev.1.0 Mar 2020)

### Corporate Headquarters

TOYOSU FORESIA, 3-2-24 Toyosu,  
Koto-ku, Tokyo 135-0061, Japan  
[www.renesas.com](http://www.renesas.com)

### Contact Information

For further information on a product, technology, the most up-to-date version of a document, or your nearest sales office, please visit:  
[www.renesas.com/contact/](http://www.renesas.com/contact/)

### Trademarks

Renesas and the Renesas logo are trademarks of Renesas Electronics Corporation. All trademarks and registered trademarks are the property of their respective owners.