

PART NAME	HAND HELD ENCLOSURE (STYLE G)	PART No.	HH-3496-B & HH-3496-G	REV. DATE	
-----------	-------------------------------	----------	-----------------------	-----------	--

MATERIAL:
HIGH-IMPACT ABS (FLAMMABILITY RATING OF UL94V-0)

FINISH:
(SUFFIX -B) _____ BLACK
(SUFFIX -G) _____ LIGHT GRAY

ALL DIMENSIONS HAVE ± 0.015 TOLERANCE.

FOUR (4) M3 x 1.173 LG. SCREWS SUPPLIED FOR ASSEMBLY.
ONE (1) M3 x 0.394 LG. SCREW SUPPLIED FOR TILT STAND.
WALL MOUNT/TILT STAND SUPPLIED UNASSEMBLED.
OPTIONAL ACCESSORIES: HH-3441-G GASKET

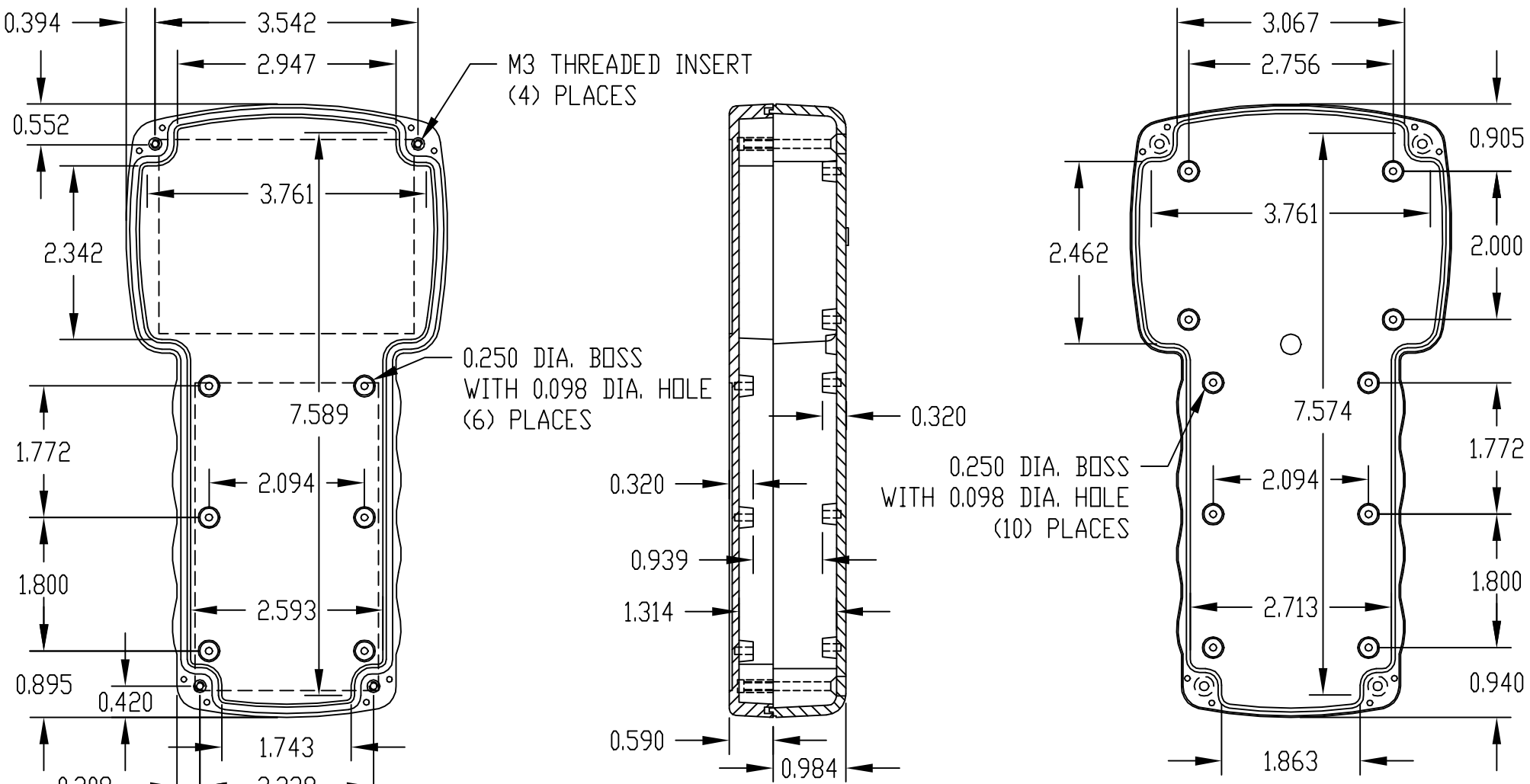
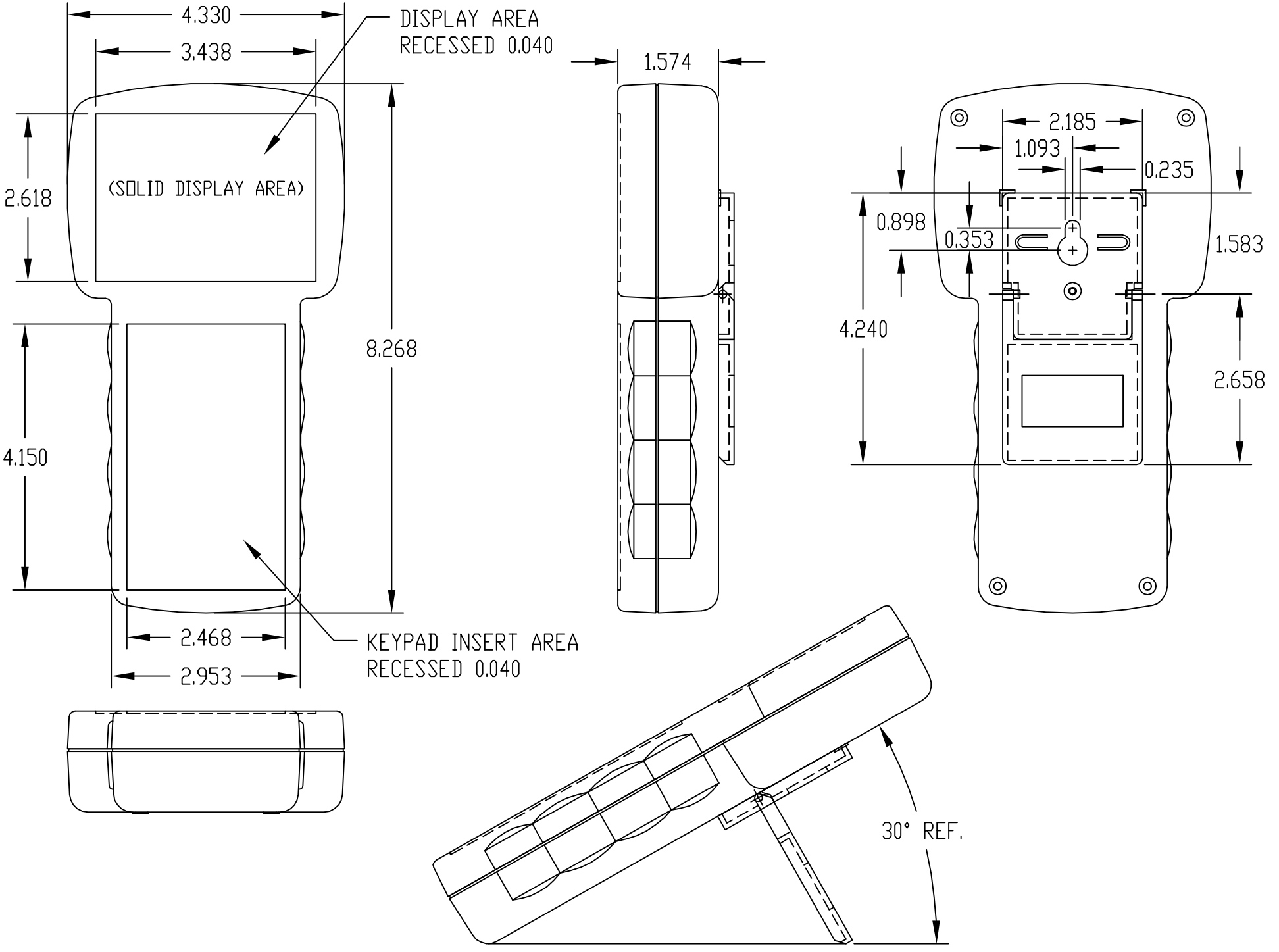

NOTE: MOUNTING BOSSES USE EITHER M2.5 METRIC OR #4 STD. SHEET METAL SCREWS x 0.250 LG (NOT SUPPLIED)

INSIDE VIEW OF BOTTOM

INSIDE VIEW OF TOP