

**67 mΩ R<sub>DS(ON)</sub> 2A High-Side Load Switch  
in 0.85 mm x 0.85 mm FTDFN Package**

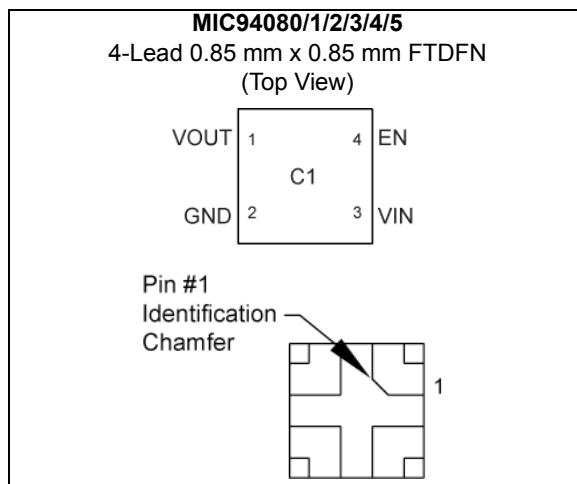
## Features

- Space-Saving 0.85 mm x 0.85 mm 4-Lead FTDFN Package
- Input Voltage Range: 1.7V to 5.5V
- 2A Continuous Operating Current
- 67 mΩ R<sub>DS(ON)</sub>
- Internal Level Shift for CMOS/TTL Control Logic
- Ultra-Low Quiescent Current
- Micropower Shutdown Current
- Soft-Start: MIC94082/3 (800 μs), MIC94084/5 (120 μs)
- Load Discharge Circuit: MIC94081, MIC94083, MIC94085
- Ultra-Fast Turn-Off Time
- -40°C to +125°C Junction Operating Temperature

## Applications

- Cellular Phones
- Portable Navigation Devices (PND)
- Personal Media Players (PMP)
- Ultra-Mobile PCs
- Portable Instrumentation
- Other Portable Applications
- PDAs
- GPS Modules
- Industrial and Datacom Equipment

## Package Type



## General Description

The MIC94080/1/2/3/4/5 is a family of high-side load switches designed to operate from 1.7V to 5.5V input voltage. The load switch pass element is an internal 67 mΩ R<sub>DS(ON)</sub> P-Channel MOSFET that enables the device to support up to 2A of continuous current. Additionally, the load switch supports 1.5V logic level control and shutdown features in a tiny 0.85 mm x 0.85 mm 4-lead FTDFN package.

The MIC94080 and MIC94081 feature rapid turn on. The MIC94082 and MIC94083 provide a slew rate controlled soft-start turn-on of 800 μs, while the MIC94084 and MIC94085 provide a slew rate controlled soft-start turn-on of 120 μs. The soft-start feature is provided to prevent an in-rush current event from pulling down the input supply voltage.

The MIC94081, MIC94083, and MIC94085 feature an active load discharge circuit which switches in a 250Ω load when the switch is disabled to automatically discharge a capacitive load.

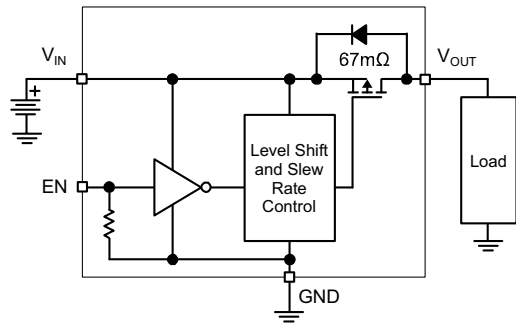
An active pull-down on the enable input keeps the MIC94080/1/2/3/4/5 in a default OFF state until the enable pin is pulled above 1.25V. Internal level shift circuitry allows low voltage logic signals to switch higher supply voltages. The enable voltage can be as high as 5.5V and is not limited by the input voltage.

The MIC94080/1/2/3/4/5 operating voltage range makes them ideal for Lithium ion and NiMH/NiCad/Alkaline battery powered systems, as well as non-battery powered applications. The devices provide low quiescent current and low shutdown current to maximize battery life.

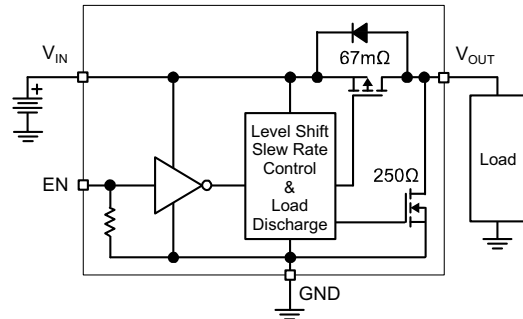
# MIC94080/1/2/3/4/5

## Typical Application Circuits

MIC94080 (Ultra-Fast Turn-On)  
MIC94082 (800  $\mu$ s Soft-Start)  
MIC94084 (120  $\mu$ s Soft-Start)



MIC94081 (Ultra-Fast Turn-On w/ Auto-Discharge)  
MIC94083 (800  $\mu$ s Soft-Start w/ Auto-Discharge)  
MIC94085 (120  $\mu$ s Soft-Start w/ Auto-Discharge)



## 1.0 ELECTRICAL CHARACTERISTICS

### Absolute Maximum Ratings †

Input Voltage ( $V_{IN}$ ) .....	+6V
Enable Voltage ( $V_{EN}$ ) .....	+6V
Continuous Drain Current ( $I_D$ ) (Note 1)	
$T_A = +25^\circ\text{C}$ .....	$\pm 2.0\text{A}$
$T_A = +85^\circ\text{C}$ .....	$\pm 1.5\text{A}$
Pulsed Drain Current ( $I_{DP}$ ) (Note 2) .....	$\pm 6.0\text{A}$
Continuous Diode Current ( $I_S$ ) (Note 3) .....	-50 mA
Storage Temperature ( $T_S$ ) .....	-55°C to +150°C
ESD Rating (HBM, Note 4) .....	3 kV

### Operating Ratings ††

Input Voltage ( $V_{IN}$ ) .....	+1.7V to +5.5V
Junction Temperature Range ( $T_J$ ) .....	-40°C to +125°C
Package Thermal Resistance	
4-Ld FTDFN 0.85 mm x 0.85 mm ( $\theta_{JA}$ ) .....	140°C/W
4-Ld FTDFN 0.85 mm x 0.85 mm ( $\theta_{JC}$ ) .....	85°C/W

**† Notice:** Stresses above those listed under “Absolute Maximum Ratings” may cause permanent damage to the device. This is a stress rating only and functional operation of the device at those or any other conditions above those indicated in the operational sections of this specification is not intended. Exposure to maximum rating conditions for extended periods may affect device reliability.

**†† Notice:** The device is not guaranteed to function outside its operating ratings.

**Note 1:** With thermal contact to PCB. See Thermal Considerations section.

**2:** Pulse width <300  $\mu\text{s}$  with <2% duty cycle.

**3:** Continuous body diode current conduction (reverse conduction, i.e.  $V_{OUT}$  to  $V_{IN}$ ) is not recommended.

**4:** Devices are ESD sensitive. Handling precautions recommended. Human body model, 1.5 k $\Omega$  in series with 100 pF.

# MIC94080/1/2/3/4/5

## ELECTRICAL CHARACTERISTICS

Electrical Characteristics:  $T_A = +25^\circ\text{C}$ , **bold** values indicate  $-40^\circ\text{C} \leq T_A \leq +85^\circ\text{C}$ , unless noted.

Parameter	Sym.	Min.	Typ.	Max.	Units	Conditions
Enable Threshold Voltage	$V_{EN\_TH}$	<b>0.4</b>	—	<b>1.25</b>	V	$V_{IN} = 1.7\text{V to } 4.5\text{V}$ , $I_D = -250\ \mu\text{A}$
Quiescent Current	$I_Q$	—	0.1	<b>1</b>	$\mu\text{A}$	$V_{IN} = V_{EN} = 5.5\text{V}$ , $I_D = \text{OPEN}$ Measured on $V_{IN}$ MIC94080/1
		—	8	<b>15</b>		$V_{IN} = V_{EN} = 5.5\text{V}$ , $I_D = \text{OPEN}$ Measured on $V_{IN}$ MIC94082/3/4/5
Enable Input Current	$I_{EN}$	—	2.8	<b>4</b>	$\mu\text{A}$	$V_{IN} = V_{EN} = 5.5\text{V}$ , $I_D = \text{OPEN}$
Quiescent Current (Shutdown)	$I_{SHUT-Q}$	—	0.02	<b>1</b>	$\mu\text{A}$	$V_{IN} = +5.5\text{V}$ , $V_{EN} = 0\text{V}$ , $I_D = \text{OPEN}$ Measured on $V_{IN}$ , <a href="#">Note 1</a>
OFF State Leakage Current	$I_{SHUT-SWITCH}$	—	0.02	<b>1</b>	$\mu\text{A}$	$V_{IN} = +5.5\text{V}$ , $V_{EN} = 0\text{V}$ , $I_D = \text{SHORT}$ Measured on $V_{IN}$ , <a href="#">Note 1</a>
P-Channel Drain-to-Source ON Resistance	$R_{DS(ON)}$	—	67	<b>115</b>	$\text{m}\Omega$	$V_{IN} = +5.0\text{V}$ , $I_D = -100\ \text{mA}$ , $V_{EN} = 1.5\text{V}$
		—	70	<b>130</b>		$V_{IN} = +4.5\text{V}$ , $I_D = -100\ \text{mA}$ , $V_{EN} = 1.5\text{V}$
		—	80	<b>165</b>		$V_{IN} = +3.6\text{V}$ , $I_D = -100\ \text{mA}$ , $V_{EN} = 1.5\text{V}$
		—	110	<b>225</b>		$V_{IN} = +2.5\text{V}$ , $I_D = -100\ \text{mA}$ , $V_{EN} = 1.5\text{V}$
		—	175	<b>350</b>		$V_{IN} = +1.8\text{V}$ , $I_D = -100\ \text{mA}$ , $V_{EN} = 1.5\text{V}$
		—	200	<b>375</b>		$V_{IN} = +1.7\text{V}$ , $I_D = -100\ \text{mA}$ , $V_{EN} = 1.5\text{V}$
Turn-Off Resistance	$R_{SHUTDOWN}$	—	250	<b>400</b>	$\Omega$	$V_{IN} = +3.6\text{V}$ , $I_{TEST} = 1\ \text{mA}$ , $V_{EN} = 0\text{V}$ MIC94081/3/5
<b>Dynamic Electrical Characteristics</b>						
Turn-On Delay	$t_{ON\_DLY}$	—	0.4	1.5	$\mu\text{s}$	$V_{IN} = +3.6\text{V}$ , $I_D = -100\ \text{mA}$ , $V_{EN} = 1.5\text{V}$ MIC94080, MIC94081
		200	600	1500		$V_{IN} = +3.6\text{V}$ , $I_D = -100\ \text{mA}$ , $V_{EN} = 1.5\text{V}$ MIC94082, MIC94083
		65	110	165		$V_{IN} = +3.6\text{V}$ , $I_D = -100\ \text{mA}$ , $V_{EN} = 1.5\text{V}$ MIC94084, MIC94085
Turn-On Rise Time	$t_{ON\_RISE}$	—	0.4	1.5	$\mu\text{s}$	$V_{IN} = +3.6\text{V}$ , $I_D = -100\ \text{mA}$ , $V_{EN} = 1.5\text{V}$ MIC94080, MIC94081
		400	800	1500		$V_{IN} = +3.6\text{V}$ , $I_D = -100\ \text{mA}$ , $V_{EN} = 1.5\text{V}$ MIC94082, MIC94083
		65	120	175		$V_{IN} = +3.6\text{V}$ , $I_D = -100\ \text{mA}$ , $V_{EN} = 1.5\text{V}$ MIC94084, MIC94085
Turn-Off Delay Time	$t_{OFF\_DLY}$	—	60	200	ns	$V_{IN} = +3.6\text{V}$ , $I_D = -100\ \text{mA}$ , $V_{EN} = 0\text{V}$
Turn-Off Fall Time	$t_{OFF\_FALL}$	—	20	100	ns	$V_{IN} = +3.6\text{V}$ , $I_D = -100\ \text{mA}$ , $V_{EN} = 0\text{V}$

**Note 1:** Measured on the MIC94080YFT.

## TEMPERATURE SPECIFICATIONS

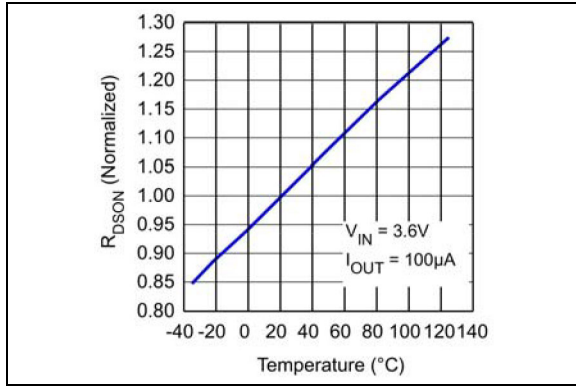
Parameters	Sym.	Min.	Typ.	Max.	Units	Conditions
<b>Temperature Ranges</b>						
Junction Temperature Range	$T_J$	-40	—	+125	°C	—
Storage Temperature Range	$T_S$	-55	—	+150	°C	—
<b>Package Thermal Resistances</b>						
Thermal Resistance, 4-Ld FTDFN 0.85 mm x 0.85 mm	$\theta_{JA}$	—	140	—	°C/W	—
Thermal Resistance, 4-Ld FTDFN 0.85 mm x 0.85 mm	$\theta_{JC}$	—	85	—	°C/W	—

**Note 1:** The maximum allowable power dissipation is a function of ambient temperature, the maximum allowable junction temperature and the thermal resistance from junction to air (i.e.,  $T_A$ ,  $T_J$ ,  $\theta_{JA}$ ). Exceeding the maximum allowable power dissipation will cause the device operating junction temperature to exceed the maximum +125°C rating. Sustained junction temperatures above +125°C can impact the device reliability.

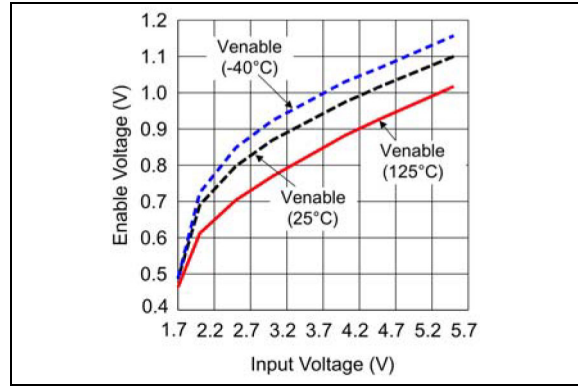
# MIC94080/1/2/3/4/5

## 2.0 TYPICAL PERFORMANCE CURVES

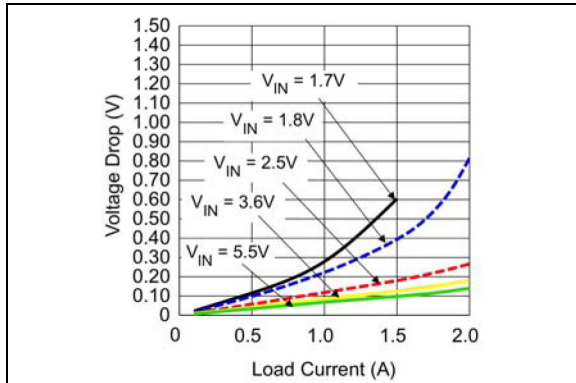
**Note:** The graphs and tables provided following this note are a statistical summary based on a limited number of samples and are provided for informational purposes only. The performance characteristics listed herein are not tested or guaranteed. In some graphs or tables, the data presented may be outside the specified operating range (e.g., outside specified power supply range) and therefore outside the warranted range.



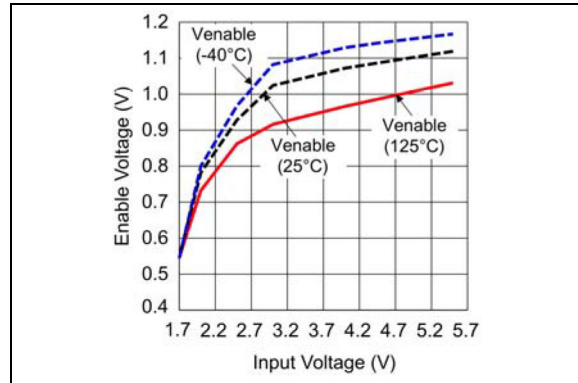
**FIGURE 2-1:** MIC94080/1/2/3/4/5  $R_{DS(ON)}$  Variance vs. Temperature.



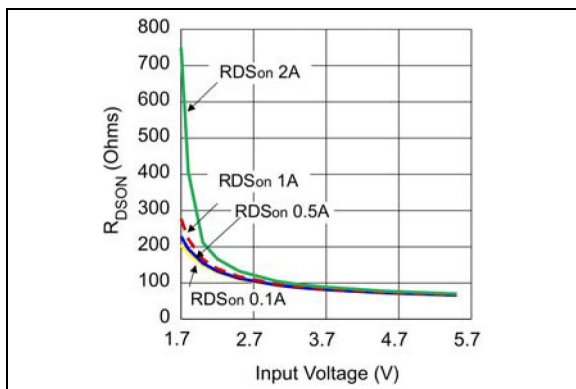
**FIGURE 2-4:** MIC94080/1 Enable Threshold vs. Input Voltage.



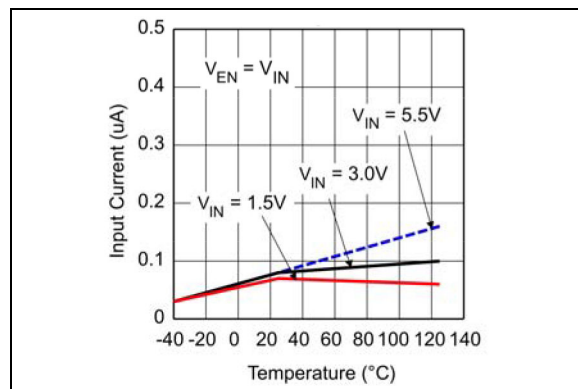
**FIGURE 2-2:** MIC94080/1/2/3/4/5 Voltage Drop vs. Load Current.



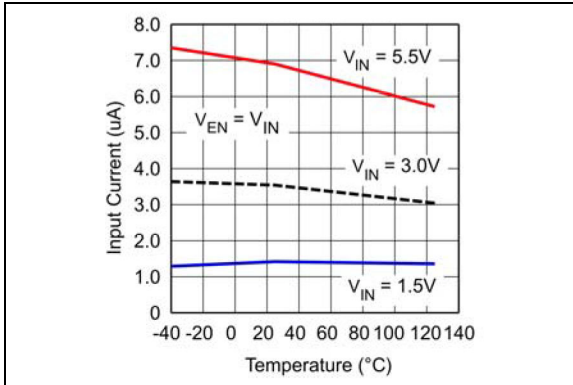
**FIGURE 2-5:** MIC94082/3/4/5 Enable Threshold vs. Input Voltage.



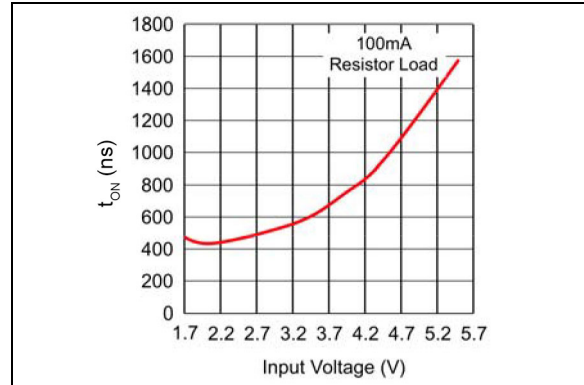
**FIGURE 2-3:** MIC94080/1/2/3/4/5 On Resistance vs. Input Voltage.



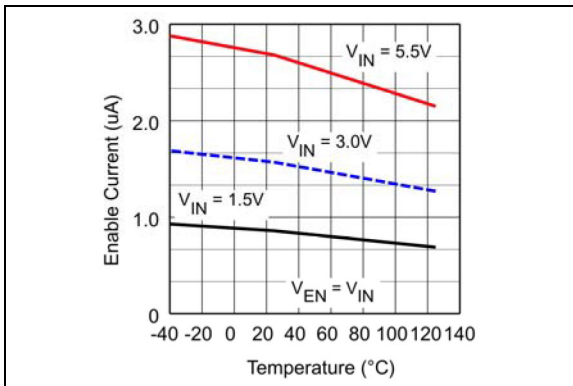
**FIGURE 2-6:** MIC94080/1 Input Current vs. Temperature.



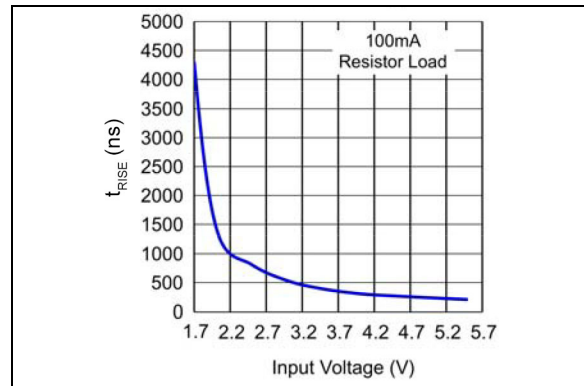
**FIGURE 2-7:** MIC94082/3/4/5 Input Current vs. Temperature.



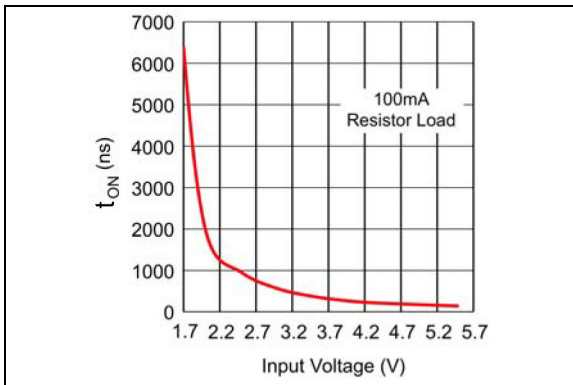
**FIGURE 2-10:** MIC94082/3  $t_{ON}$  Delay vs. Input Voltage.



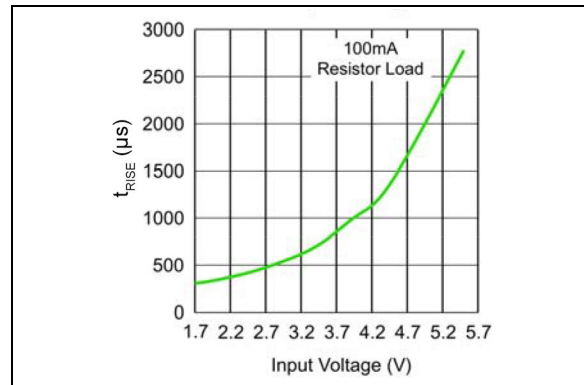
**FIGURE 2-8:** MIC94081/2/3/4/5 Enable Current vs. Temperature.



**FIGURE 2-11:** MIC94080/1 Rise Time vs. Input Voltage.

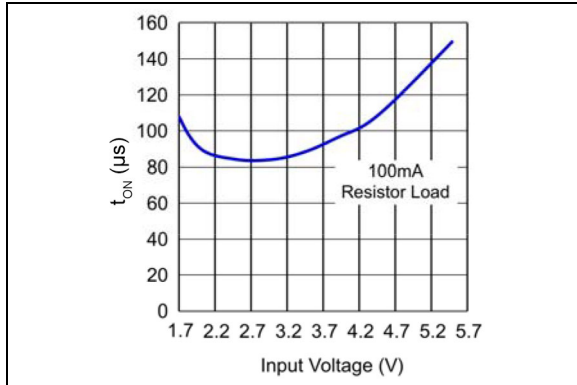


**FIGURE 2-9:** MIC94080/1  $t_{ON}$  Delay vs. Input Voltage.

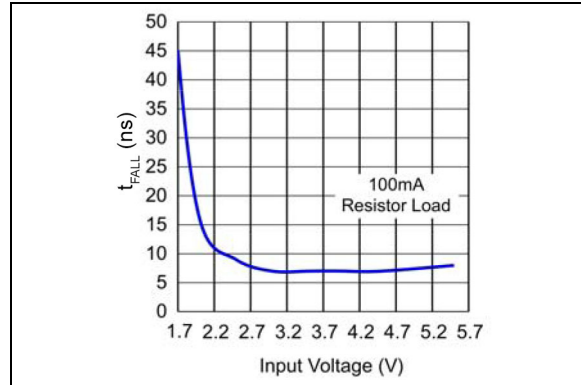


**FIGURE 2-12:** MIC94082/3 Rise Time vs. Input Voltage.

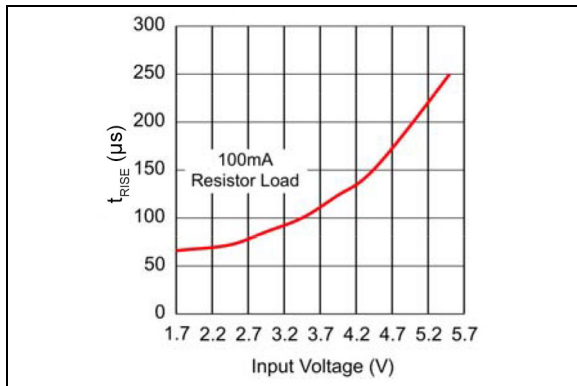
# MIC94080/1/2/3/4/5



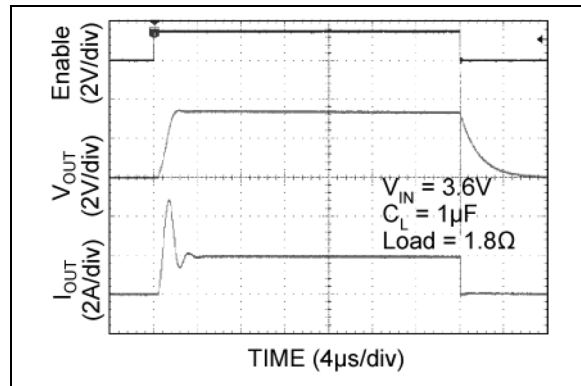
**FIGURE 2-13:** MIC94084/5  $t_{ON}$  Delay vs. Input Voltage.



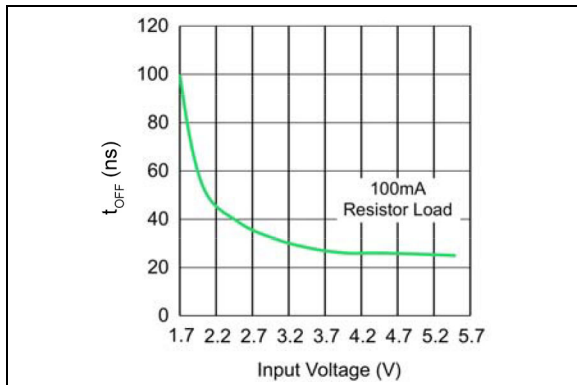
**FIGURE 2-16:** MIC94080/1/2/3/4/5 Fall Time vs. Input Voltage.



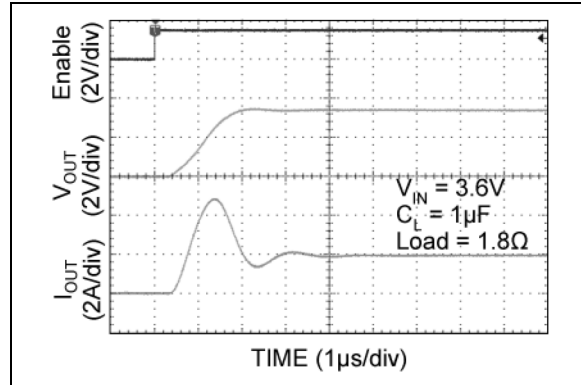
**FIGURE 2-14:** MIC94084/5 Rise Time vs. Input Voltage.



**FIGURE 2-17:** MIC94080 Scope 1.

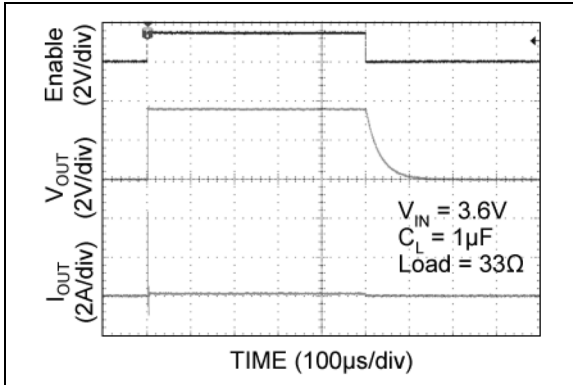


**FIGURE 2-15:** MIC94080/1/2/3/4/5  $t_{OFF}$  Delay vs. Input Voltage.

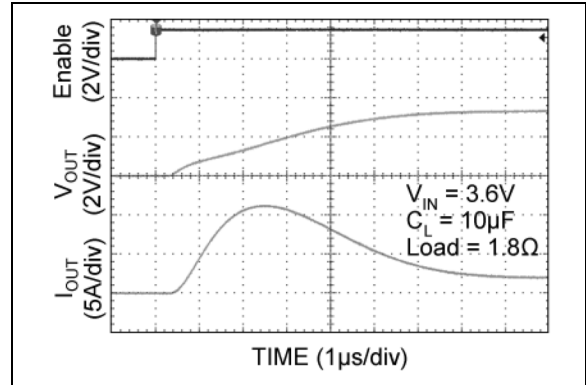


**FIGURE 2-18:** MIC94080 Scope 2.

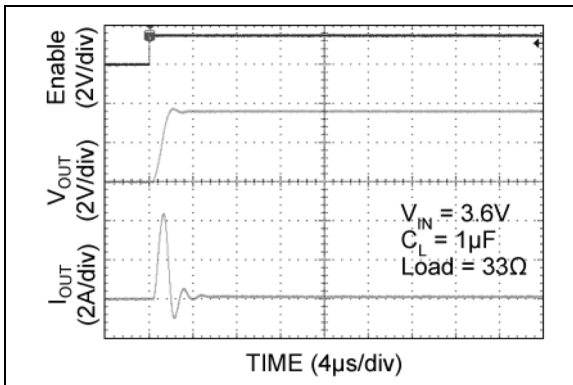




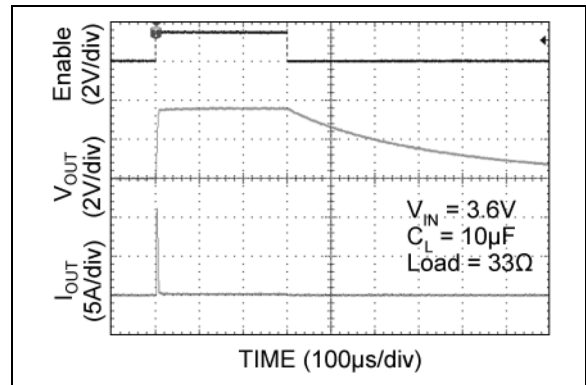
**FIGURE 2-19:** MIC94080 Scope 3.



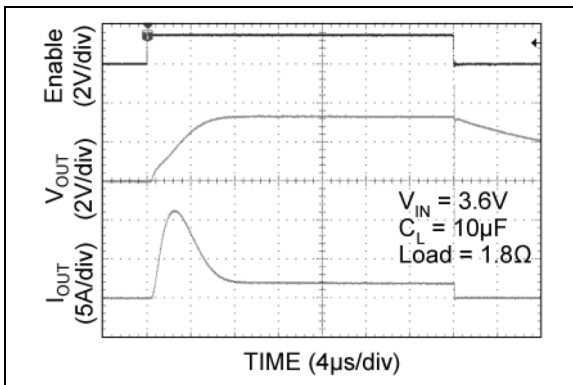
**FIGURE 2-22:** MIC94080 Scope 6.



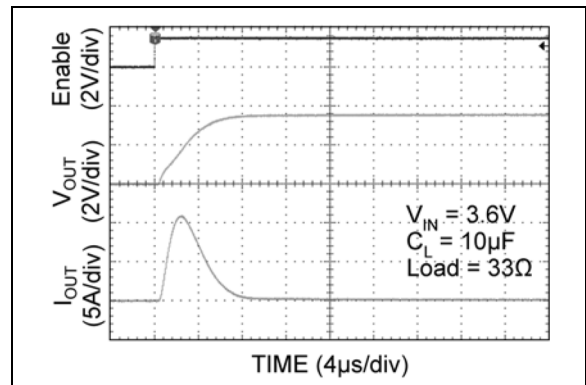
**FIGURE 2-20:** MIC94080 Scope 4.



**FIGURE 2-23:** MIC94080 Scope 7.

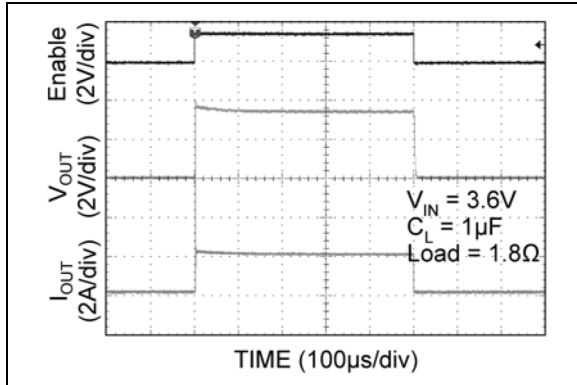


**FIGURE 2-21:** MIC94080 Scope 5.

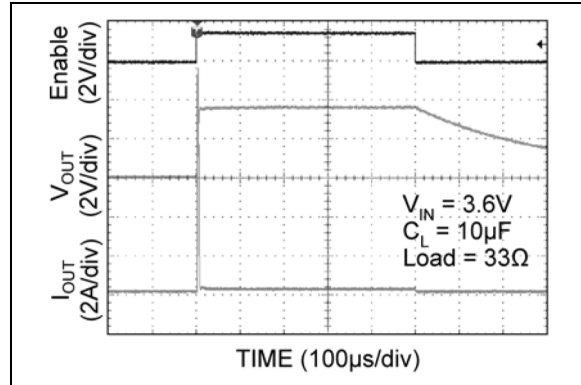


**FIGURE 2-24:** MIC94080 Scope 8.

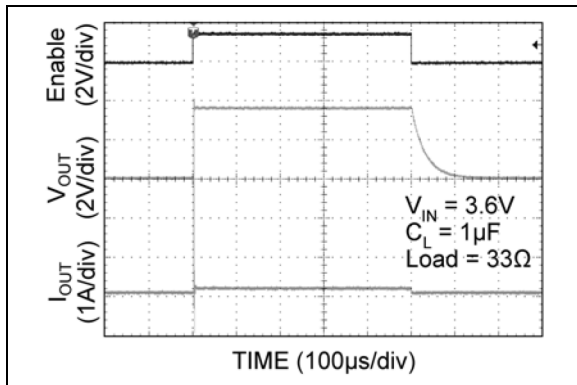
# MIC94080/1/2/3/4/5



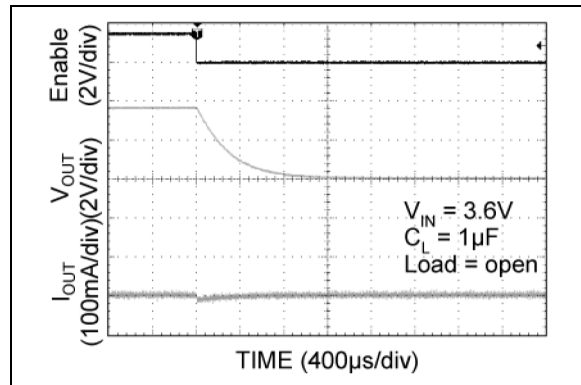
**FIGURE 2-25:** MIC94081 Scope 1.



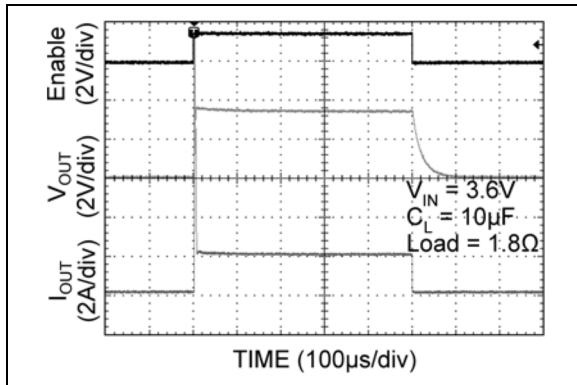
**FIGURE 2-28:** MIC94081 Scope 4.



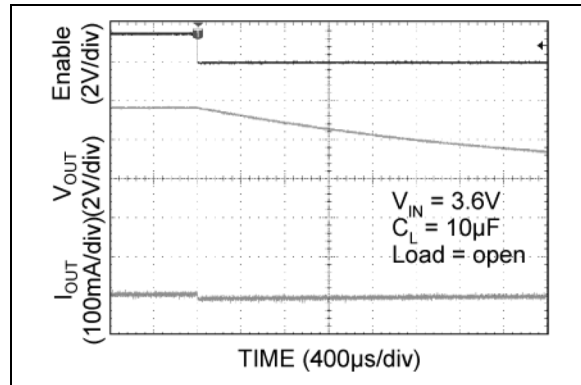
**FIGURE 2-26:** MIC94081 Scope 2.



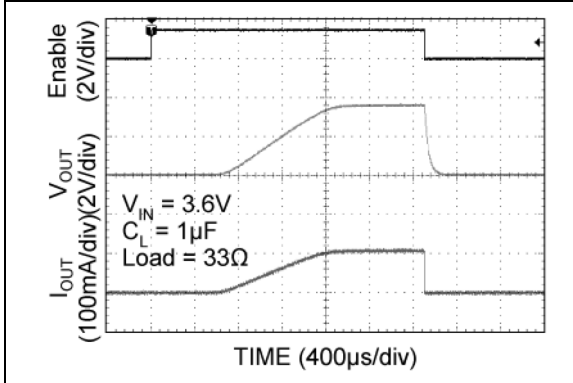
**FIGURE 2-29:** MIC94081 Scope 5.



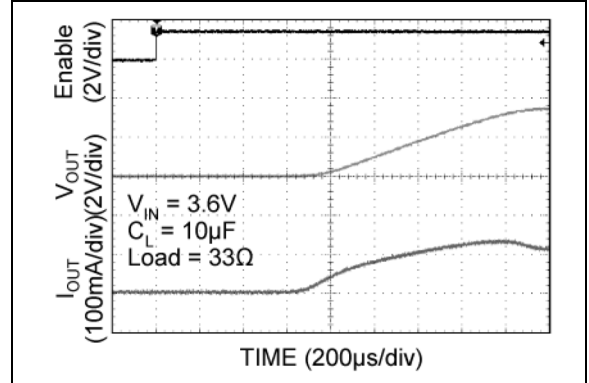
**FIGURE 2-27:** MIC94081 Scope 3.



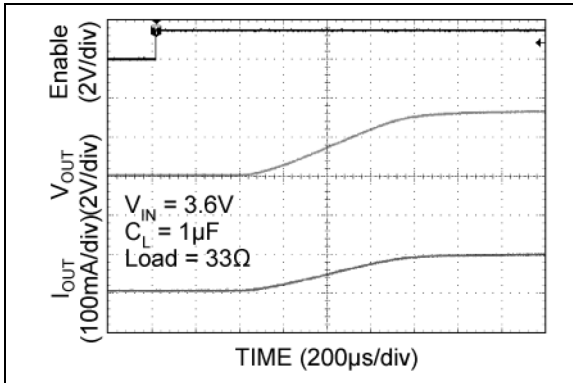
**FIGURE 2-30:** MIC94081 Scope 6.



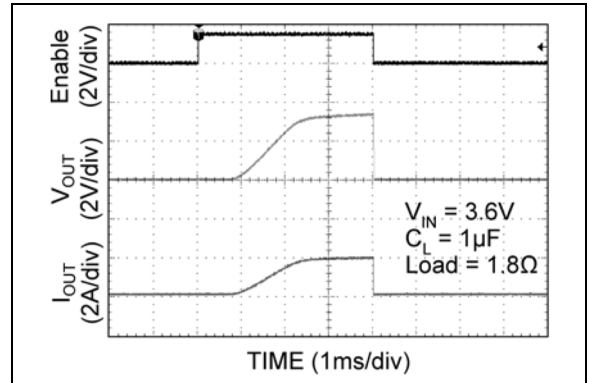
**FIGURE 2-31:** MIC94082 Scope 1.



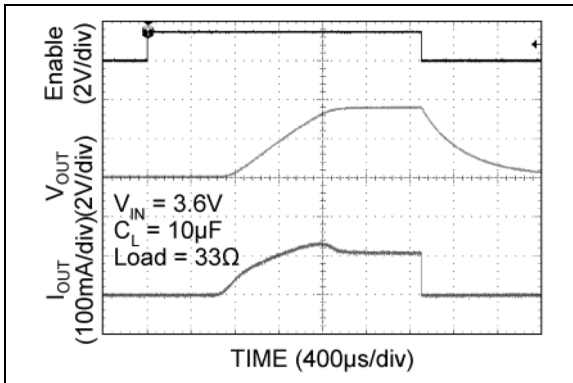
**FIGURE 2-34:** MIC94082 Scope 4.



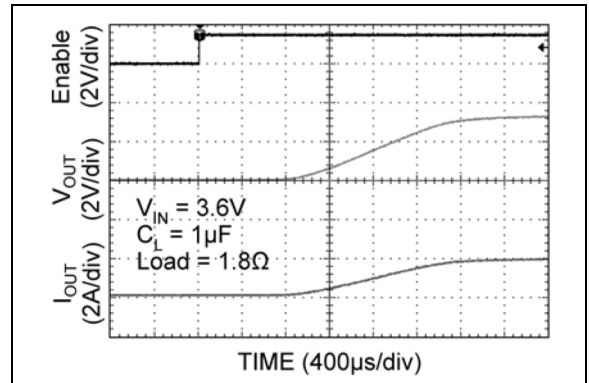
**FIGURE 2-32:** MIC94082 Scope 2.



**FIGURE 2-35:** MIC94082 Scope 5.

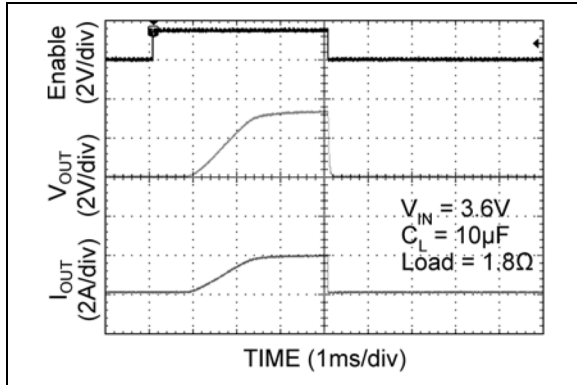


**FIGURE 2-33:** MIC94082 Scope 3.

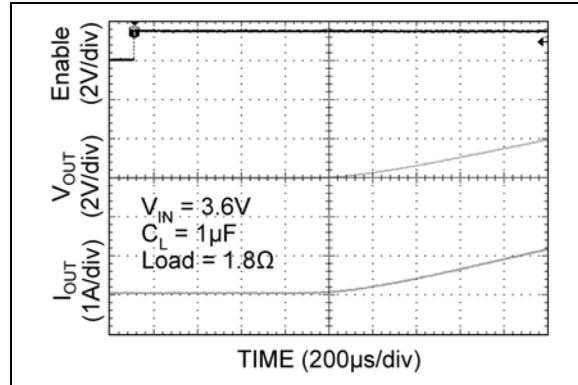


**FIGURE 2-36:** MIC94082 Scope 6.

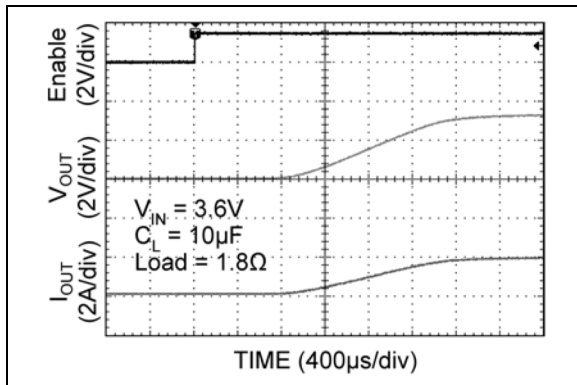
# MIC94080/1/2/3/4/5



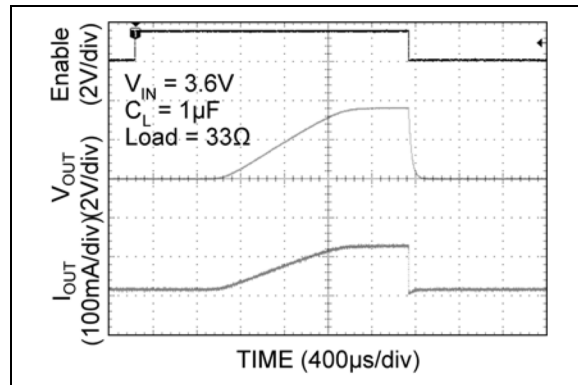
**FIGURE 2-37:** MIC94082 Scope 7.



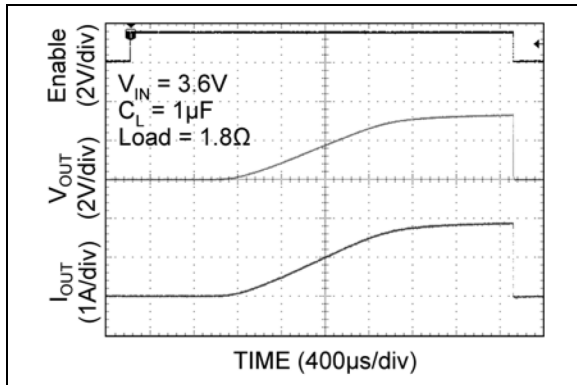
**FIGURE 2-40:** MIC94083 Scope 2.



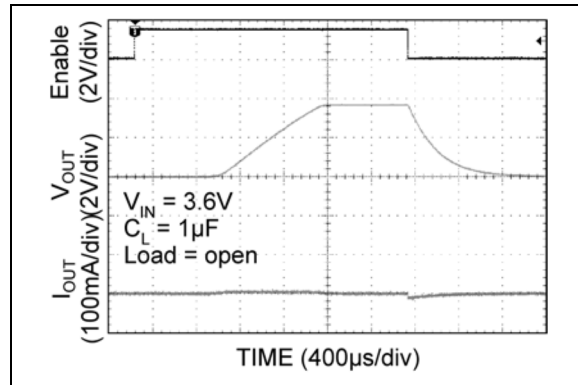
**FIGURE 2-38:** MIC94082 Scope 8.



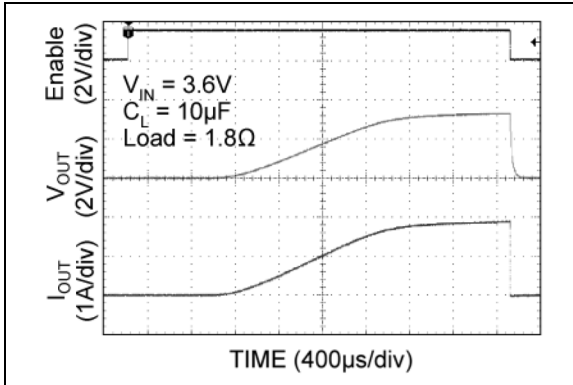
**FIGURE 2-41:** MIC94083 Scope 3.



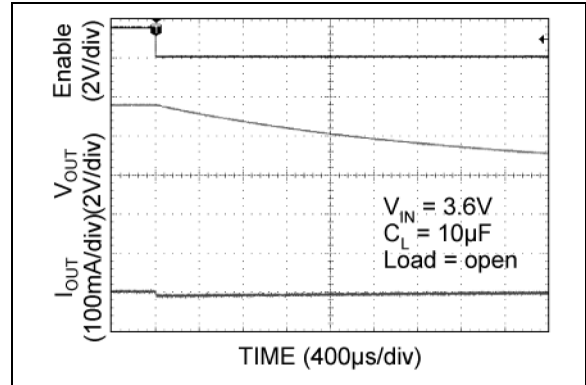
**FIGURE 2-39:** MIC94083 Scope 1.



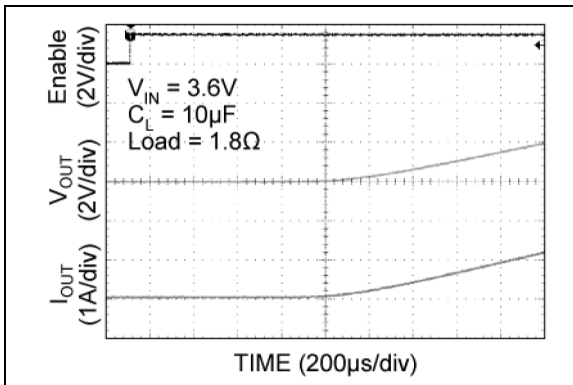
**FIGURE 2-42:** MIC94083 Scope 4.



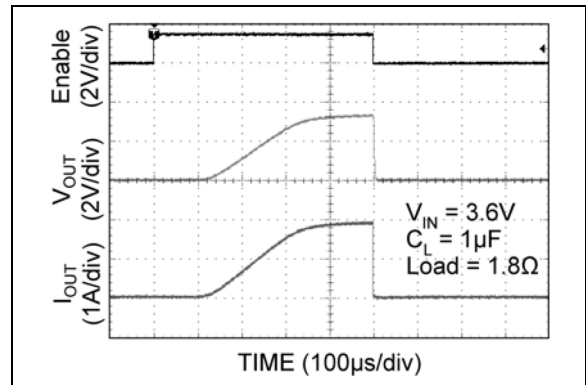
**FIGURE 2-43:** MIC94083 Scope 5.



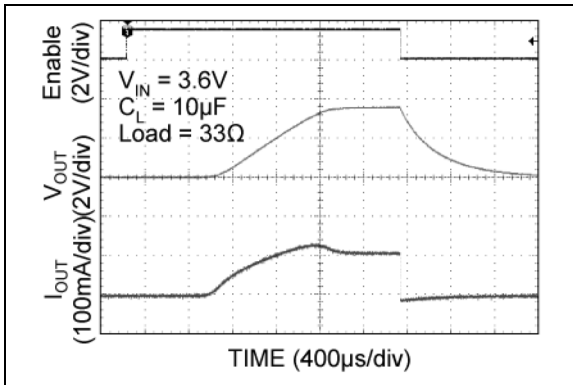
**FIGURE 2-46:** MIC94083 Scope 8.



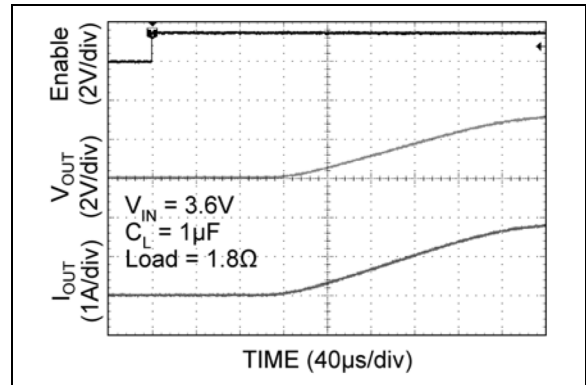
**FIGURE 2-44:** MIC94083 Scope 6.



**FIGURE 2-47:** MIC94084 Scope 1.

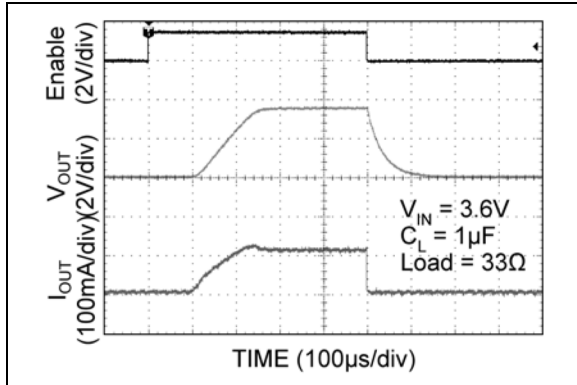


**FIGURE 2-45:** MIC94083 Scope 7.

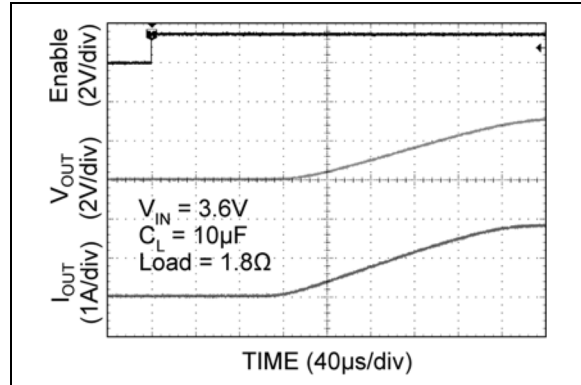


**FIGURE 2-48:** MIC94084 Scope 2.

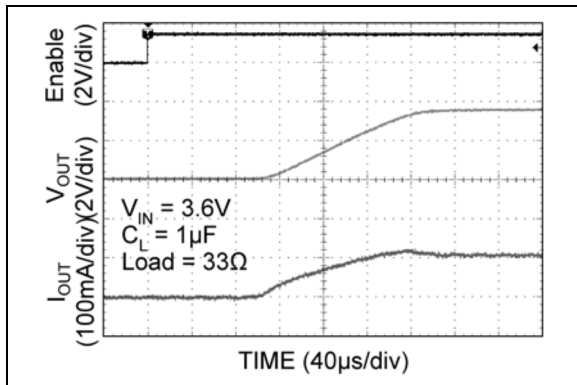
# MIC94080/1/2/3/4/5



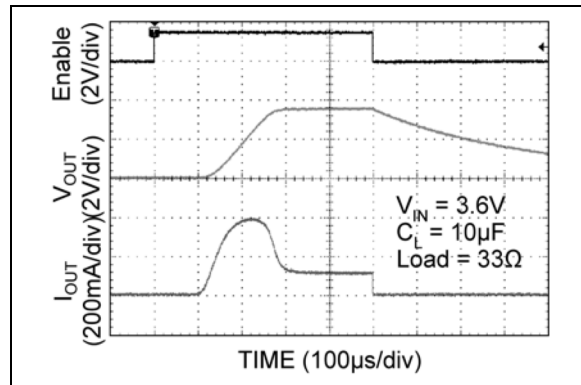
**FIGURE 2-49:** MIC94084 Scope 3.



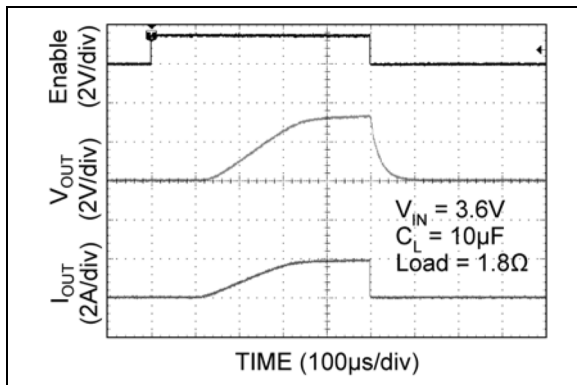
**FIGURE 2-52:** MIC94084 Scope 6.



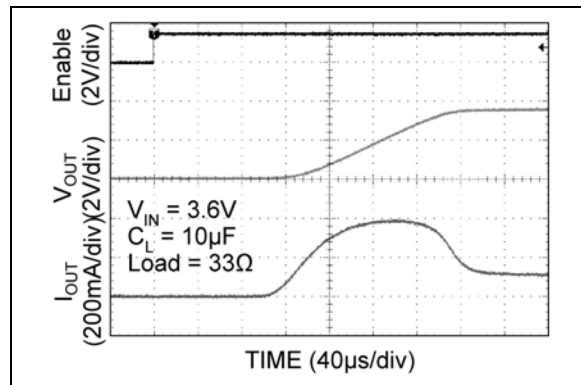
**FIGURE 2-50:** MIC94084 Scope 4.



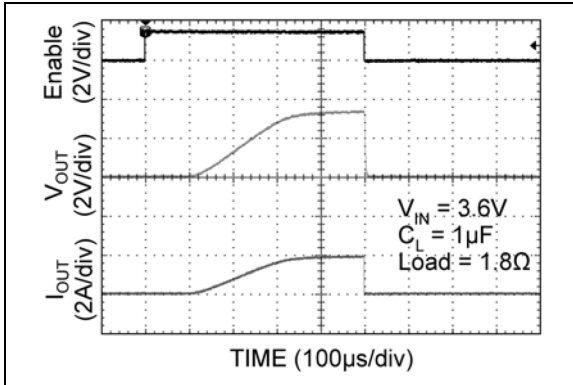
**FIGURE 2-53:** MIC94084 Scope 7.



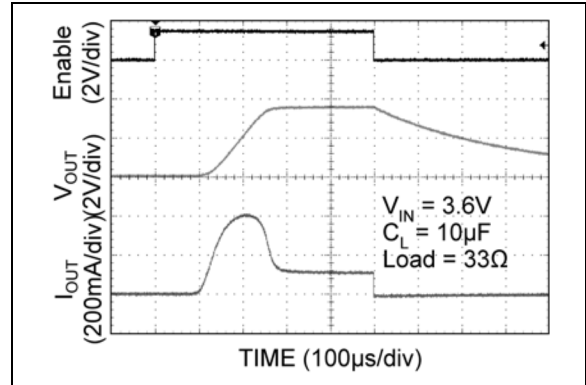
**FIGURE 2-51:** MIC94084 Scope 5.



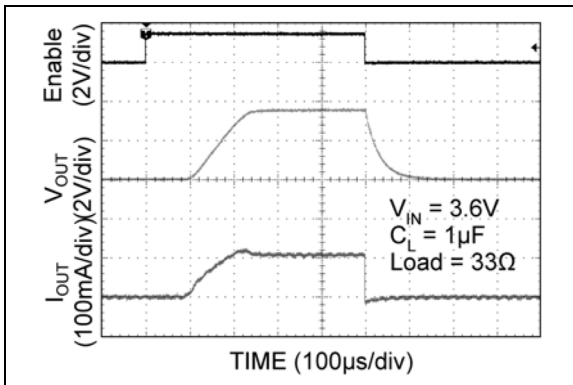
**FIGURE 2-54:** MIC94084 Scope 8.



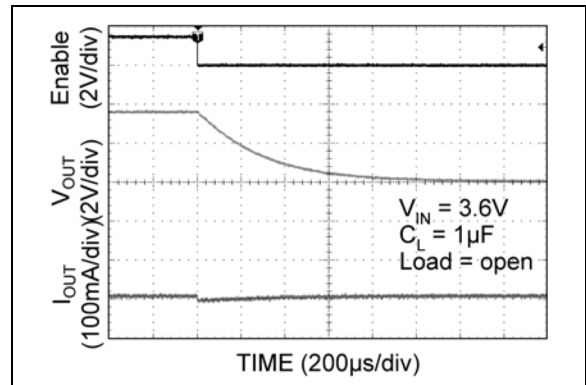
**FIGURE 2-55:** MIC94085 Scope 1.



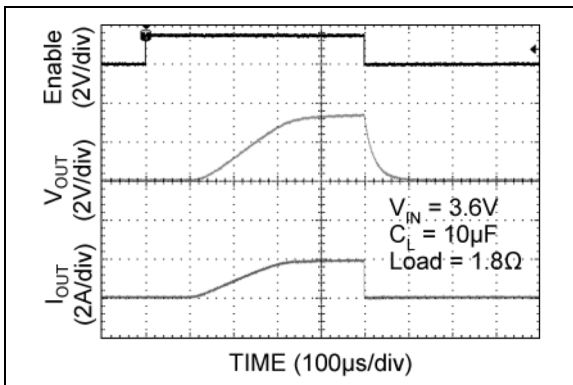
**FIGURE 2-58:** MIC94085 Scope 4.



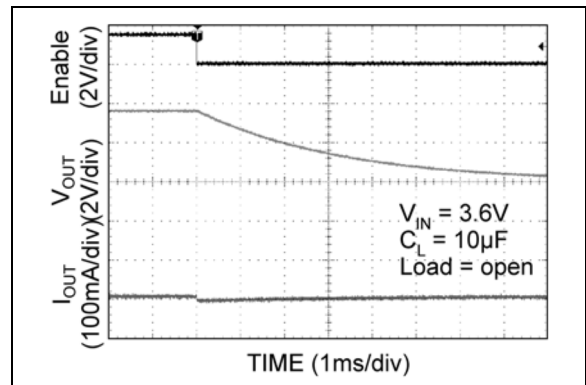
**FIGURE 2-56:** MIC94085 Scope 2.



**FIGURE 2-59:** MIC94085 Scope 5.



**FIGURE 2-57:** MIC94085 Scope 3.



**FIGURE 2-60:** MIC94085 Scope 6.

# MIC94080/1/2/3/4/5

---

## 3.0 PIN DESCRIPTIONS

The descriptions of the pins are listed in [Table 3-1](#).

**TABLE 3-1: PIN FUNCTION TABLE**

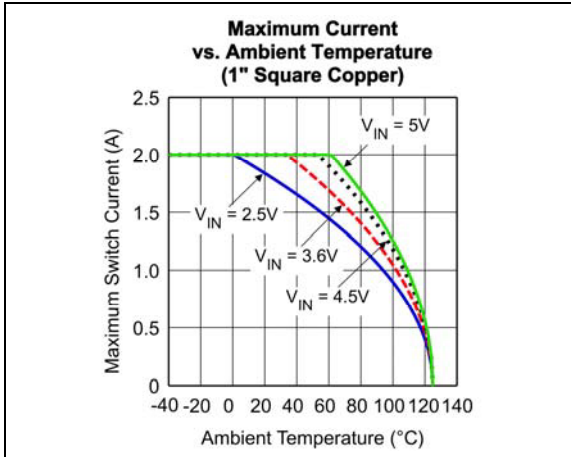
Pin Number	Pin Name	Description
1	V <sub>OUT</sub>	Drain of P-Channel MOSFET.
2	GND	Ground. Should be connected to electrical ground.
3	V <sub>IN</sub>	Source of P-Channel MOSFET.
4	EN	Enable (Input): Active-high CMOS/TTL control input for switch. Internal ~2 M $\Omega$ pull-down resistor. Output will be off if this pin is left floating.



## 4.0 APPLICATION INFORMATION

### 4.1 Power Switch SOA

The safe operating area (SOA) curve represents the boundary of maximum safe operating current and maximum safe operating junction temperature.

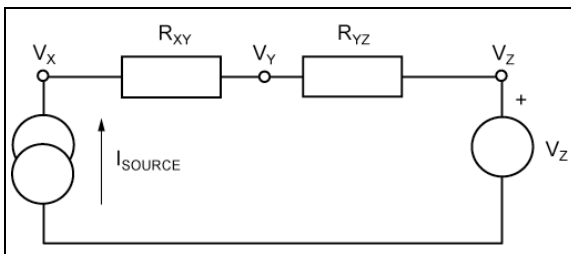


**FIGURE 4-1:** SOA Graph.

The curves above show the SOA for various  $V_{IN}$  values mounted on a typical one-layer, 1 square inch copper board.

### 4.2 Power Dissipation Considerations

As with all power switches, the current rating of the switch is limited mostly by the thermal properties of the package and the PCB on which it's mounted. There is a simple Ohm's law type relationship between thermal resistance, power dissipation, and temperature that are analogous to an electrical circuit.



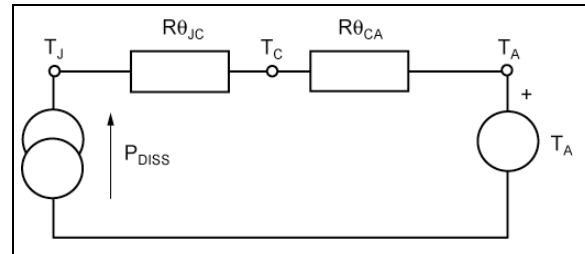
**FIGURE 4-2:** Simple Electrical Circuit.

From this simple circuit, one can calculate  $V_X$  if one knows  $I_{SOURCE}$ ,  $V_Z$ , and the resistor values for  $R_{XY}$  and  $R_{YZ}$  using [Equation 4-1](#).

#### EQUATION 4-1:

$$V_X = I_{SOURCE} \times (R_{XY} + R_{YZ}) + V_Z$$

Thermal circuits can be considered using these same rules and can be drawn similarly by replacing current sources with power dissipation (in Watts), resistance with thermal resistance (in °C/W), and voltage sources with temperature (in °C).



**FIGURE 4-3:** Simple Thermal Circuit.

By replacing the variables in the equation for  $V_X$ , one can find the junction temperature ( $T_J$ ) from power dissipation, ambient temperature, and then know thermal resistance of the PCB ( $R_{\theta_{CA}}$ ) and the package ( $R_{\theta_{JC}}$ ).

#### EQUATION 4-2:

$$T_J = P_{DISS} \times (R_{\theta_{JC}} + R_{\theta_{CA}}) + T_A$$

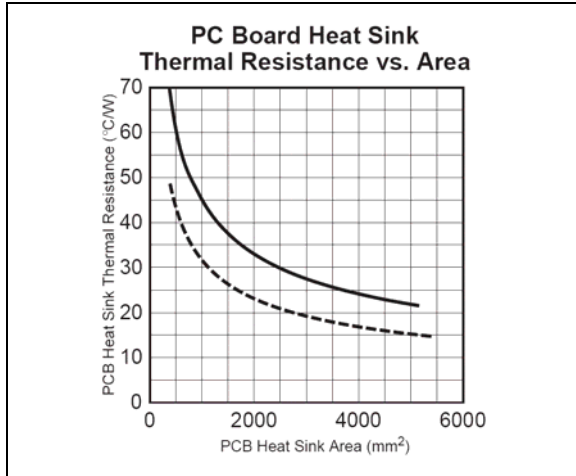
$P_{DISS}$  is calculated as  $I_{SWITCH}^2 \times R_{SW(MAX)}$ .  $R_{\theta_{JC}}$  is found in the [Temperature Specifications](#) section of this data sheet and  $R_{\theta_{CA}}$  (the PCB thermal resistance) values for various PCB copper areas is discussed in [Designing with Low Dropout Voltage Regulators](#).

#### 4.2.1 AN EXAMPLE

A switch is intended to drive a 1A load and is placed on a PCB that has a ground plane area of at least 25 mm by 25 mm (625 mm<sup>2</sup>). The voltage source is a Li-ion battery with a lower operating threshold of 3V and the ambient temperature of the assembly can be up to 50°C.

Summary of variables:

- $I_{SW} = 1A$
- $V_{IN} = 3V$  to  $4.2V$
- $T_A = 50^\circ C$
- $R_{\theta_{JC}} = 85^\circ C/W$
- $R_{\theta_{CA}} = 53^\circ C/W$  (as read from [Figure 4-4](#))



**FIGURE 4-4:** Excerpt from the LDO Book.

#### EQUATION 4-3:

$$P_{DISS} = I_{SW}^2 \times R_{SW(MAX)}$$

The worst case switch resistance ( $R_{SW(MAX)}$ ) at the lowest  $V_{IN}$  of 3V is not available in the data sheet, so the next lowest value of  $V_{IN}$  is used.

$R_{SW(MAX)}$  at 2.5V is 200 mΩ.

An additional consideration is to allow for the maximum junction temperature of 125°C. If this was a calculation for the worst case  $R_{SW(MAX)}$  for 25°C, the actual worst case resistance in this case can be 30% higher (see [Figure 2-1](#)). However, 200 mΩ is the maximum over temperature. Therefore:

#### EQUATION 4-4:

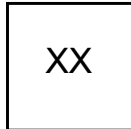
$$T_J = 1^2 \times 0.2 \times (85 + 53) + 50 = 78^\circ C$$

This is below the maximum of 125°C.

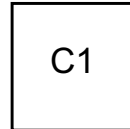
## 5.0 PACKAGING INFORMATION

### 5.1 Package Marking Information

4-Lead FTDFN\*



Example



**TABLE 5-1: MARKING CODES**

Part Number	Marking Code	Features
MIC94080YFT-TR	C1	Fast Turn-On
MIC94081YFT-TR	C2	Fast Turn-On, Load Discharge
MIC94082YFT-TR	C5	800 $\mu$ s Soft-Start
MIC94083YFT-TR	C7	800 $\mu$ s Soft-Start, Load Discharge
MIC94084YFT-TR	C0	120 $\mu$ s Soft-Start
MIC94085YFT-TR	1C	120 $\mu$ s Soft-Start, Load Discharge

<p><b>Legend:</b> XX...X Product code or customer-specific information          Y Year code (last digit of calendar year)          YY Year code (last 2 digits of calendar year)          WW Week code (week of January 1 is week '01')          NNN Alphanumeric traceability code          (e3) Pb-free JEDEC<sup>®</sup> designator for Matte Tin (Sn)          * This package is Pb-free. The Pb-free JEDEC designator ((e3)) can be found on the outer packaging for this package.</p> <p>•, ▲, ▼ Pin one index is identified by a dot, delta up, or delta down (triangle mark).</p>
<p><b>Note:</b> In the event the full Microchip part number cannot be marked on one line, it will be carried over to the next line, thus limiting the number of available characters for customer-specific information. Package may or may not include the corporate logo.</p> <p>Underbar ( ) and/or Overbar ( ) symbol may not be to scale.</p>

# MIC94080/1/2/3/4/5

## 4-Lead FTDFN Package Outline & Recommended Land Pattern

**TITLE**  
4 LEAD FTDFN 0.85x0.85 mm PACKAGE (Flip Chip) OUTLINE & RECOMMENDED LAND PATTERN

<b>DRAWING #</b>	FTDFN085085-4LD-PL-1	<b>UNIT</b>	MM
<b>LEAD FRAME</b>	Copper Alloy	<b>LEAD FINISH</b>	NiPdAu

**TOP VIEW**  
NOTE: 1, 2, 3

**BOTTOM VIEW**  
NOTE: 1, 2, 3

**END VIEW**  
NOTE: 1, 2, 3

**NOTE:**

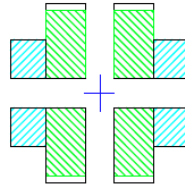
1. MAX PACKAGE WARPAGE IS 0.05 MM
2. MAX ALLOWABLE BURR IS 0.076 MM IN ALL DIRECTIONS
3. PIN #1 IS ON TOP WILL BE LASER MARKED
4. GREEN COLORED RECTANGLES (SHADED AREA) REPRESENT SOLDER STENCIL OPENING ON EXPOSED METAL TRACE.
5. CYAN COLORED RECTANGLES (SHADED AREA) REPRESENT OPTIONAL SOLDER STENCIL OPENING.

Note: For the most current package drawings, please see the Microchip Packaging Specification located at <http://www.microchip.com/packaging>.

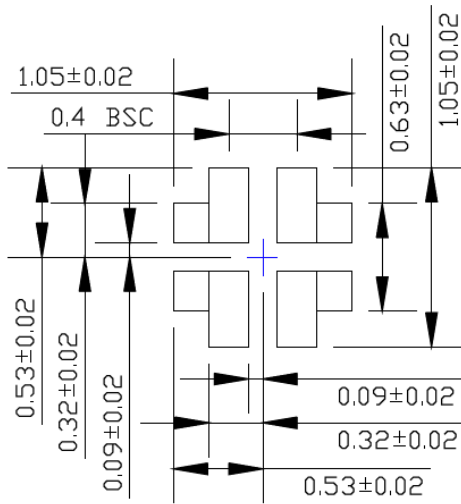
POD-Land Pattern drawing #FTDFN085085-4LD-PL-1

## RECOMMENDED LAND PATTERN

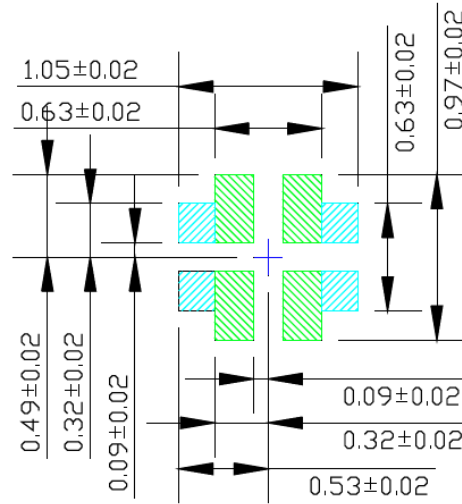
NOTE: 4, 5



STACKED-UP



EXPOSED METAL TRACE



SOLDER STENCIL OPENING

Note: For the most current package drawings, please see the Microchip Packaging Specification located at <http://www.microchip.com/packaging>.

# MIC94080/1/2/3/4/5

---

NOTES:

## APPENDIX A: REVISION HISTORY

### Revision A (March 2019)

- Converted Micrel document MIC94080/1/2/3/4/5 to Microchip data sheet template DS20006118A.
- Minor grammatical text changes throughout.

# MIC94080/1/2/3/4/5

---

NOTES:



## PRODUCT IDENTIFICATION SYSTEM

To order or obtain information, e.g., on pricing or delivery, contact your local Microchip representative or sales office.

Device	<u>X</u>	<u>XX</u>	<u>-XX</u>	Examples:
Part No.	Junction Temp. Range	Package	Media Type	
<b>Device:</b>				
MIC94080:		67 mΩ R <sub>DS(ON)</sub> 2A High-Side Load Switch with Fast Turn-On		a) MIC94080YFT-TR: MIC94080, -40°C to +125°C Temperature Range, 4-Lead FTDFN, 5,000/Reel
MIC94081:		67 mΩ R <sub>DS(ON)</sub> 2A High-Side Load Switch with Fast Turn-On and Load Discharge		b) MIC94081YFT-TR: MIC94081, -40°C to +125°C Temperature Range, 4-Lead FTDFN, 5,000/Reel
MIC94082:		67 mΩ R <sub>DS(ON)</sub> 2A High-Side Load Switch with 800 μs Soft-Start		c) MIC94082YFT-TR: MIC94082, -40°C to +125°C Temperature Range, 4-Lead FTDFN, 5,000/Reel
MIC94083:		67 mΩ R <sub>DS(ON)</sub> 2A High-Side Load Switch with 800 μs Soft-Start and Load Discharge		d) MIC94083YFT-TR: MIC94083, -40°C to +125°C Temperature Range, 4-Lead FTDFN, 5,000/Reel
MIC94084:		67 mΩ R <sub>DS(ON)</sub> 2A High-Side Load Switch with 120 μs Soft-Start		e) MIC94084YFT-TR: MIC94084, -40°C to +125°C Temperature Range, 4-Lead FTDFN, 5,000/Reel
MIC94085:		67 mΩ R <sub>DS(ON)</sub> 2A High-Side Load Switch with 120 μs Soft-Start and Load Discharge		f) MIC94085YFT-TR: MIC94085, -40°C to +125°C Temperature Range, 4-Lead FTDFN, 5,000/Reel
<b>Junction Temperature Range:</b>	Y =	-40°C to +125°C, RoHS-Compliant		<b>Note 1:</b> Tape and Reel identifier only appears in the catalog part number description. This identifier is used for ordering purposes and is not printed on the device package. Check with your Microchip Sales Office for package availability with the Tape and Reel option.
<b>Package:</b>	FT =	4-Lead 0.85 mm x 0.85 mm FTDFN		
<b>Media Type:</b>	TR =	5,000/Reel		

# MIC94080/1/2/3/4/5

---

NOTES:

---

---

**Note the following details of the code protection feature on Microchip devices:**

- Microchip products meet the specification contained in their particular Microchip Data Sheet.
- Microchip believes that its family of products is one of the most secure families of its kind on the market today, when used in the intended manner and under normal conditions.
- There are dishonest and possibly illegal methods used to breach the code protection feature. All of these methods, to our knowledge, require using the Microchip products in a manner outside the operating specifications contained in Microchip's Data Sheets. Most likely, the person doing so is engaged in theft of intellectual property.
- Microchip is willing to work with the customer who is concerned about the integrity of their code.
- Neither Microchip nor any other semiconductor manufacturer can guarantee the security of their code. Code protection does not mean that we are guaranteeing the product as “unbreakable.”

Code protection is constantly evolving. We at Microchip are committed to continuously improving the code protection features of our products. Attempts to break Microchip's code protection feature may be a violation of the Digital Millennium Copyright Act. If such acts allow unauthorized access to your software or other copyrighted work, you may have a right to sue for relief under that Act.

---

Information contained in this publication regarding device applications and the like is provided only for your convenience and may be superseded by updates. It is your responsibility to ensure that your application meets with your specifications. MICROCHIP MAKES NO REPRESENTATIONS OR WARRANTIES OF ANY KIND WHETHER EXPRESS OR IMPLIED, WRITTEN OR ORAL, STATUTORY OR OTHERWISE, RELATED TO THE INFORMATION, INCLUDING BUT NOT LIMITED TO ITS CONDITION, QUALITY, PERFORMANCE, MERCHANTABILITY OR FITNESS FOR PURPOSE. Microchip disclaims all liability arising from this information and its use. Use of Microchip devices in life support and/or safety applications is entirely at the buyer's risk, and the buyer agrees to defend, indemnify and hold harmless Microchip from any and all damages, claims, suits, or expenses resulting from such use. No licenses are conveyed, implicitly or otherwise, under any Microchip intellectual property rights unless otherwise stated.

*Microchip received ISO/TS-16949:2009 certification for its worldwide headquarters, design and wafer fabrication facilities in Chandler and Tempe, Arizona; Gresham, Oregon and design centers in California and India. The Company's quality system processes and procedures are for its PIC® MCUs and dsPIC® DSCs, KEELOQ® code hopping devices, Serial EEPROMs, microperipherals, nonvolatile memory and analog products. In addition, Microchip's quality system for the design and manufacture of development systems is ISO 9001:2000 certified.*

**QUALITY MANAGEMENT SYSTEM  
CERTIFIED BY DNV  
= ISO/TS 16949 =**

### Trademarks

The Microchip name and logo, the Microchip logo, AnyRate, AVR, AVR logo, AVR Freaks, BitCloud, chipKIT, chipKIT logo, CryptoMemory, CryptoRF, dsPIC, FlashFlex, flexPWR, Helder, JukeBlox, KeeLoq, Klear, LANCheck, LINK MD, maXStylus, maXTouch, MediaLB, megaAVR, MOST, MOST logo, MPLAB, OptoLyzer, PIC, picoPower, PICSTART, PIC32 logo, Prochip Designer, QTouch, SAM-BA, SpyNIC, SST, SST Logo, SuperFlash, tinyAVR, UNI/O, and XMEGA are registered trademarks of Microchip Technology Incorporated in the U.S.A. and other countries.

ClockWorks, The Embedded Control Solutions Company, EtherSynch, Hyper Speed Control, HyperLight Load, IntellIMOS, mTouch, Precision Edge, and Quiet-Wire are registered trademarks of Microchip Technology Incorporated in the U.S.A.

Adjacent Key Suppression, AKS, Analog-for-the-Digital Age, Any Capacitor, AnyIn, AnyOut, BodyCom, CodeGuard, CryptoAuthentication, CryptoAutomotive, CryptoCompanion, CryptoController, dsPICDEM, dsPICDEM.net, Dynamic Average Matching, DAM, ECAN, EtherGREEN, In-Circuit Serial Programming, ICSP, INICnet, Inter-Chip Connectivity, JitterBlocker, KlearNet, KlearNet logo, memBrain, Mindi, MiWi, motorBench, MPASM, MPF, MPLAB Certified logo, MPLIB, MPLINK, MultiTRAK, NetDetach, Omniscient Code Generation, PICDEM, PICDEM.net, PICKit, PICtail, PowerSmart, PureSilicon, QMatrix, REAL ICE, Ripple Blocker, SAM-ICE, Serial Quad I/O, SMART-I.S., SQI, SuperSwitcher, SuperSwitcher II, Total Endurance, TSHARC, USBCheck, VariSense, ViewSpan, WiperLock, Wireless DNA, and ZENA are trademarks of Microchip Technology Incorporated in the U.S.A. and other countries.

SQTP is a service mark of Microchip Technology Incorporated in the U.S.A.

Silicon Storage Technology is a registered trademark of Microchip Technology Inc. in other countries.

GestIC is a registered trademark of Microchip Technology Germany II GmbH & Co. KG, a subsidiary of Microchip Technology Inc., in other countries.

All other trademarks mentioned herein are property of their respective companies.

© 2019, Microchip Technology Incorporated, All Rights Reserved.  
ISBN: 978-1-5224-4271-4



# MICROCHIP

## Worldwide Sales and Service

### AMERICAS

**Corporate Office**  
2355 West Chandler Blvd.  
Chandler, AZ 85224-6199  
Tel: 480-792-7200  
Fax: 480-792-7277  
Technical Support:  
<http://www.microchip.com/support>  
Web Address:  
[www.microchip.com](http://www.microchip.com)

#### Atlanta

Duluth, GA  
Tel: 678-957-9614  
Fax: 678-957-1455

#### Austin, TX

Tel: 512-257-3370

#### Boston

Westborough, MA  
Tel: 774-760-0087  
Fax: 774-760-0088

#### Chicago

Itasca, IL  
Tel: 630-285-0071  
Fax: 630-285-0075

#### Dallas

Addison, TX  
Tel: 972-818-7423  
Fax: 972-818-2924

#### Detroit

Novi, MI  
Tel: 248-848-4000

#### Houston, TX

Tel: 281-894-5983

#### Indianapolis

Noblesville, IN  
Tel: 317-773-8323  
Fax: 317-773-5453  
Tel: 317-536-2380

#### Los Angeles

Mission Viejo, CA  
Tel: 949-462-9523  
Fax: 949-462-9608  
Tel: 951-273-7800

#### Raleigh, NC

Tel: 919-844-7510

#### New York, NY

Tel: 631-435-6000

#### San Jose, CA

Tel: 408-735-9110  
Tel: 408-436-4270

#### Canada - Toronto

Tel: 905-695-1980  
Fax: 905-695-2078

### ASIA/PACIFIC

**Australia - Sydney**  
Tel: 61-2-9868-6733

**China - Beijing**  
Tel: 86-10-8569-7000

**China - Chengdu**  
Tel: 86-28-8665-5511

**China - Chongqing**  
Tel: 86-23-8980-9588

**China - Dongguan**  
Tel: 86-769-8702-9880

**China - Guangzhou**  
Tel: 86-20-8755-8029

**China - Hangzhou**  
Tel: 86-571-8792-8115

**China - Hong Kong SAR**  
Tel: 852-2943-5100

**China - Nanjing**  
Tel: 86-25-8473-2460

**China - Qingdao**  
Tel: 86-532-8502-7355

**China - Shanghai**  
Tel: 86-21-3326-8000

**China - Shenyang**  
Tel: 86-24-2334-2829

**China - Shenzhen**  
Tel: 86-755-8864-2200

**China - Suzhou**  
Tel: 86-186-6233-1526

**China - Wuhan**  
Tel: 86-27-5980-5300

**China - Xian**  
Tel: 86-29-8833-7252

**China - Xiamen**  
Tel: 86-592-2388138

**China - Zhuhai**  
Tel: 86-756-3210040

### ASIA/PACIFIC

**India - Bangalore**  
Tel: 91-80-3090-4444

**India - New Delhi**  
Tel: 91-11-4160-8631

**India - Pune**  
Tel: 91-20-4121-0141

**Japan - Osaka**  
Tel: 81-6-6152-7160

**Japan - Tokyo**  
Tel: 81-3-6880-3770

**Korea - Daegu**  
Tel: 82-53-744-4301

**Korea - Seoul**  
Tel: 82-2-554-7200

**Malaysia - Kuala Lumpur**  
Tel: 60-3-7651-7906

**Malaysia - Penang**  
Tel: 60-4-227-8870

**Philippines - Manila**  
Tel: 63-2-634-9065

**Singapore**  
Tel: 65-6334-8870

**Taiwan - Hsin Chu**  
Tel: 886-3-577-8366

**Taiwan - Kaohsiung**  
Tel: 886-7-213-7830

**Taiwan - Taipei**  
Tel: 886-2-2508-8600

**Thailand - Bangkok**  
Tel: 66-2-694-1351

**Vietnam - Ho Chi Minh**  
Tel: 84-28-5448-2100

### EUROPE

**Austria - Wels**  
Tel: 43-7242-2244-39  
Fax: 43-7242-2244-393

**Denmark - Copenhagen**  
Tel: 45-4450-2828  
Fax: 45-4485-2829

**Finland - Espoo**  
Tel: 358-9-4520-820

**France - Paris**  
Tel: 33-1-69-53-63-20  
Fax: 33-1-69-30-90-79

**Germany - Garching**  
Tel: 49-8931-9700

**Germany - Haan**  
Tel: 49-2129-3766400

**Germany - Heilbronn**  
Tel: 49-7131-67-3636

**Germany - Karlsruhe**  
Tel: 49-721-625370

**Germany - Munich**  
Tel: 49-89-627-144-0  
Fax: 49-89-627-144-44

**Germany - Rosenheim**  
Tel: 49-8031-354-560

**Israel - Ra'anana**  
Tel: 972-9-744-7705

**Italy - Milan**  
Tel: 39-0331-742611  
Fax: 39-0331-466781

**Italy - Padova**  
Tel: 39-049-7625286

**Netherlands - Drunen**  
Tel: 31-416-690399  
Fax: 31-416-690340

**Norway - Trondheim**  
Tel: 47-7288-4388

**Poland - Warsaw**  
Tel: 48-22-3325737

**Romania - Bucharest**  
Tel: 40-21-407-87-50

**Spain - Madrid**  
Tel: 34-91-708-08-90  
Fax: 34-91-708-08-91

**Sweden - Gothenberg**  
Tel: 46-31-704-60-40

**Sweden - Stockholm**  
Tel: 46-8-5090-4654

**UK - Wokingham**  
Tel: 44-118-921-5800  
Fax: 44-118-921-5820