

PTH12060 12 Vin

Total Power: 55 Watts
of Outputs: Single

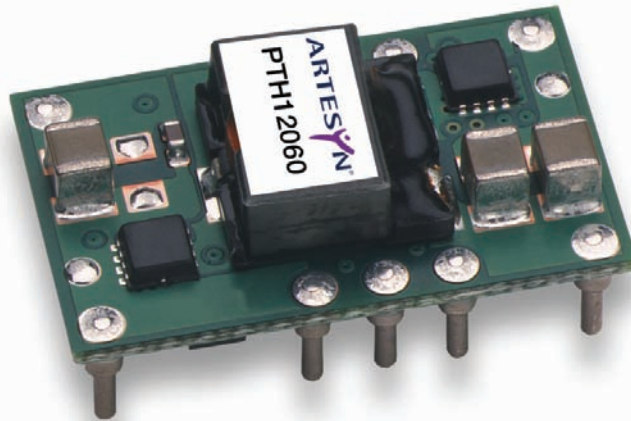

Special Features

- 10 A output current
- 12 V input voltage
- Wide-output voltage adjust
1.2 Vdc - 5.5 Vdc for suffix 'W' &
0.8 Vdc - 1.8 Vdc for suffix 'L'
- Auto-track™ sequencing*
- Margin up/down controls
- Efficiencies up to 94%
- Output ON/OFF inhibit
- Output voltage sense
- Point-of-Load-Alliance (POLA)
compatible
- Available RoHS compliant
- 2 Year Warranty

Specifications

Input		
Input voltage range:	(See Note 3, page 3)	10.8 - 13.2 Vdc
Input current:	No load	10 mA typ.
Remote ON/OFF:	(See Note 1, page 3)	Positive logic
Start-up time:		1 V/ms
Undervoltage lockout:		9.0 - 9.5 V typ.
Track input voltage:	Pin 8 (See Note 6, page 3)	± 0.3 Vin

All specifications are typical at nominal input, full load at 25 °C unless otherwise stated. $C_{in} = 560 \mu F$,
 $C_{out} = 0 \mu F$

*Auto-track™ is a trade mark of
Texas Instruments

Safety

- UL/cUL CAN/CSA-C22.2
No. 60950-1-03/UL 60950-1,
File No. E174104
- TÜV Product Service
(EN60950) Certificate No.
B 04 06 38572 044
- CB Report and Certificate to
IEC60950, Certificate No.
US/8292/UL



Specifications Continued

Output		
Voltage adjustability: (See Note 4, page 3)	Suffix 'W' Suffix 'L'	1.2 - 5.5 Vdc 0.8 - 1.8 Vdc
Setpoint accuracy:		± 2.0% Vo
Line regulation:		± 10 mV typ.
Load regulation:		± 12 mV typ.
Total regulation:		± 3.0% Vo
Minimum load:		0 A
Ripple and noise: 20 MHz bandwidth (See Note 8, page 3)	Suffix 'W' V _o 2.5 V V _o > 2.5 V Suffix 'L' V _o 1.0 V V _o > 1.0 V	25 mV pk-pk 1% V _o 20 mV pk-pk 30 mV pk-pk
Temperature co-efficient:	-40 °C to +85 °C	± 0.5% Vo
Transient response:	(See Note 5, page 3)	70 μs recovery time Overshoot/undershoot 100 mV
Margin adjustment:		± 5.0% Vo

EMC Characteristics		
Electrostatic discharge:	EN61000-4-2, IEC801-2	
Conducted immunity:	EN61000-4-6	
Radiated immunity:	EN61000-4-3	
General Specifications		
Efficiency:		See tables on page 3
Insulation voltage:		Non-isolated
Switching frequency: Over V _{in} and I _o ranges	Suffix 'W' Suffix 'L'	350 kHz typ. 250 kHz typ.
Approvals and standards:		EN60950 UL/cUL60950
Material flammability:		UL94V-0
Dimensions:	(L x W x H)	25.27 x 15.75 x 9.00 mm 0.995 x 0.620 x 0.354 in
Weight:		5 g (0.18 oz)
MTBF:	Telcordia SR-332	7,092,000 hours
Environmental Specifications		
Thermal Performance: (See Note 2, page 3)	Operating ambient, temperature Non-operating	-40 °C to +85 °C -40 °C to +125 °C
MSL ('Z' suffix only):	JEDEC J-STD-020C	Level 3
Protection		
Short-circuit:	Auto reset	20 A typ.

Ordering Information

Output Power (max)	Input Voltage	Output Voltage	Output Currents		Efficiency (max)	Regulation		Model Numbers
			Min	Max		Line	Load	
55 W	10.8 - 13.2 Vdc	0.8 - 1.8 Vdc	0 A	10 A	88%	±10 mV	±12 mV	PTH12060L
55 W	10.8 - 13.2 Vdc	1.2 - 5.5 Vdc	0 A	10 A	94%	±10 mV	±12 mV	PTH12060W

Part Number System with Options

PTH12060WAST

Product Family
Point of Load Alliance
Compatible

Input Voltage
12 = 12 V

Output Current
06 = 10 A

Mechanical Package
Always 0

Packaging Options
No Suffix = Trays
T = Tape and Reel ⁽⁷⁾

Mounting Option ⁽⁸⁾

D = Horizontal Through-Hole (RoHS 6/6)
H = Horizontal Through-Hole (RoHS 5/6)
S = Surface-Mount Solder Ball (RoHS 5/6)
Z = Surface-Mount Solder Ball (RoHS 6/6)

Pin Option

A = Through-Hole Std. Pin Length (0.140")
A = Surface-Mount Tin/Lead Solder Ball

Output Voltage Code

W = Wide
L = Low Voltage

Output Voltage Adjustment of the PTH12060 Series

The ultra-wide output voltage trim range offers major advantages to users who select the PTH12060. It is no longer necessary to purchase a variety of modules in order to cover different output voltages. The output voltage can be trimmed in a range of 1.2 Vdc to 5.5 Vdc for suffix 'W' and 0.8 Vdc to 1.8 Vdc for suffix 'L'. When the PTH12060 converter leaves the factory the output has been adjusted to the default voltage of 1.2 V for the PTH12060W and 0.8 V for the PTH12060L.

Notes

- Remote ON/OFF. Active High
ON: Pin 3 open; or $V > V_{in} - 0.5 V$
OFF: Pin 3 GND; or $V < 0.8 V$ (min - 0.2 V).
- See Figures 1, 2 and 3 for safe operating curves of PTH12060W and Figures 6, 7 and 8 for safe operating curves of PTH12060L.
- A 560 μF electrolytic input capacitor is required for proper operation. The capacitor must be rated for a minimum of 800 mA rms of ripple current.
- An external output capacitor is not required for basic operation. Adding 330 μF of distributed capacitance at the load will improve the transient response.
- 1 A/ μs load step, 50 to 100% $I_{o,max}$, $C_{out} = 330 \mu F$.
- If utilized V_{out} will track applied voltage by $\pm 0.3 V$ (up to V_o set point).
- Tape and reel packaging only available on the surface-mount versions.
- The pk-pk output ripple voltage is measured with an external 10 μF ceramic capacitor. See Figures 5 and 8 for Standard application schematic.
- To order Pb-free (RoHS compatible) surface-mount parts replace the mounting option 'S' with 'Z', e.g. PTH12060WAZ. To order Pb-free (RoHS compatible) through-hole parts replace the mounting option 'H' with 'D', e.g. PTH12060WAD.

Efficiency Table - PTH12060W ($I_o = 8 A$)

Output Voltage	Efficiency
$V_o = 5.0 V$	94%
$V_o = 3.3 V$	92%
$V_o = 2.5 V$	90%
$V_o = 2.0 V$	88%
$V_o = 1.8 V$	87%
$V_o = 1.5 V$	85%
$V_o = 1.2 V$	83%

Efficiency Table - PTH12060L ($I_o = 8 A$)

Output Voltage	Efficiency
$V_o = 1.8 V$	88%
$V_o = 1.5 V$	87%
$V_o = 1.2 V$	84%
$V_o = 1.0 V$	82%
$V_o = 0.8 V$	79%

PTH12060W Characteristic Data

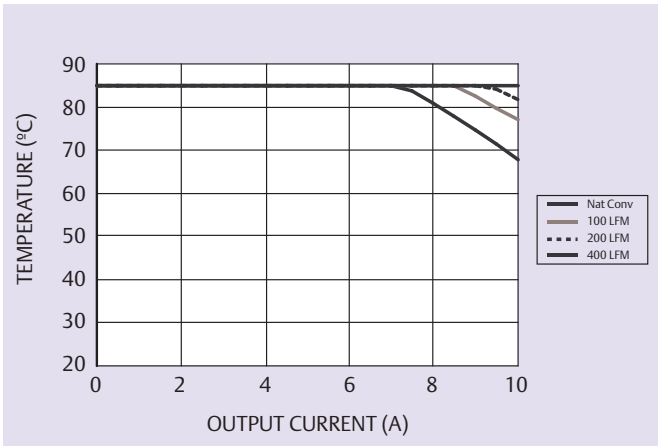

Figure 1 - Safe Operating Area
Vin = 12 V, Output Voltage = 5 V (See Note A)

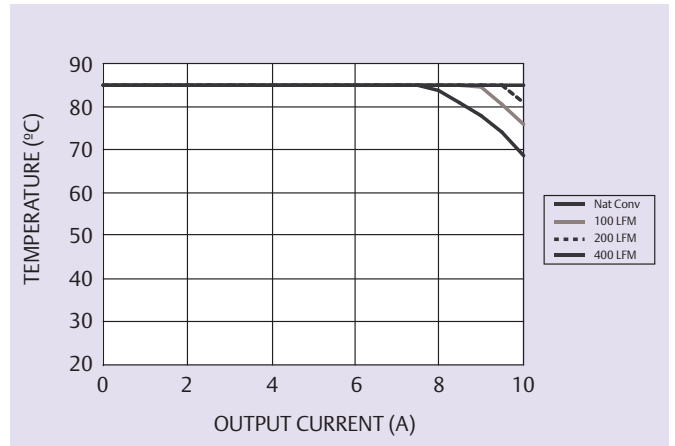

Figure 2 - Safe Operating Area
Vin = 12 V, Output Voltage = 3.3 V (See Note A)

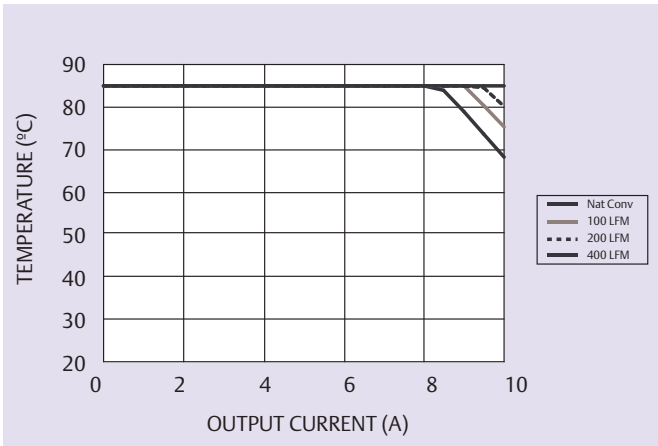

Figure 3 - Safe Operating Area
Vin = 12 V, Output Voltage = 1.8 V (See Note A)

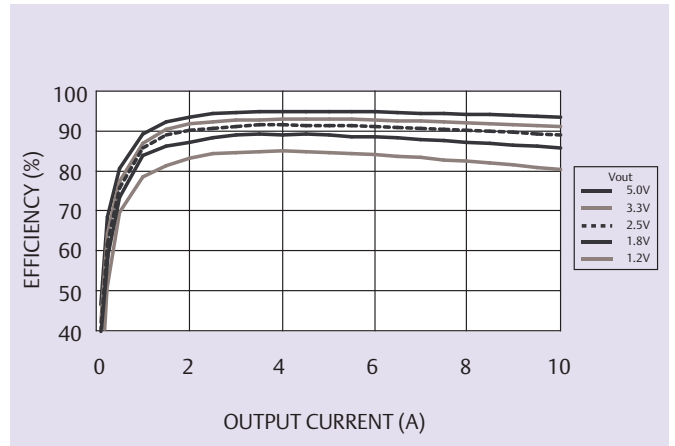

Figure 4 - Efficiency vs Load Current
Vin = 12 V (See Note B)

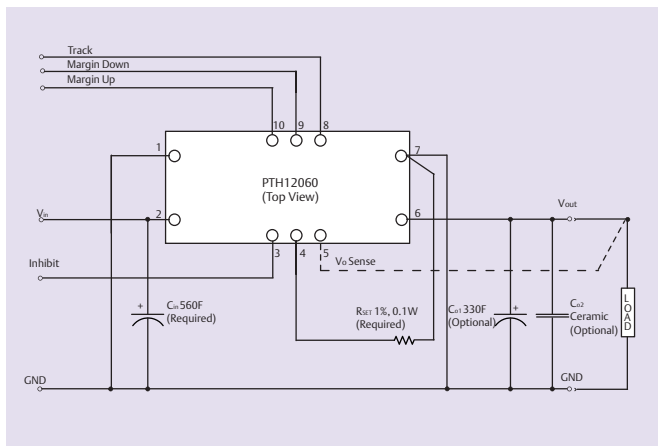

Figure 5 - Standard Application - All Models

Notes

- A SOA curves represent the conditions at which internal components are within the Emerson Network Power derating guidelines.
- B Characteristic data has been developed from actual products tested at 25 °C. This data is considered typical data for the converter.

PTH12060L Characteristic Data

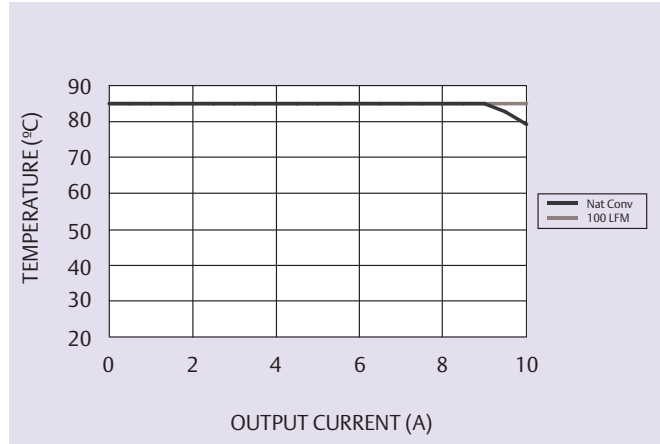

Figure 6 - Safe Operating Area
Vin = 12 V, Output Voltage = 1.8 V (See Note A)

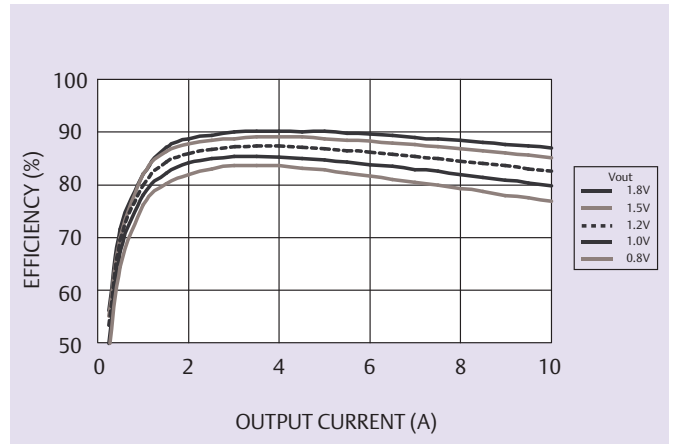

Figure 7 - Efficiency vs Load Current
Vin = 12 V (See Note B)

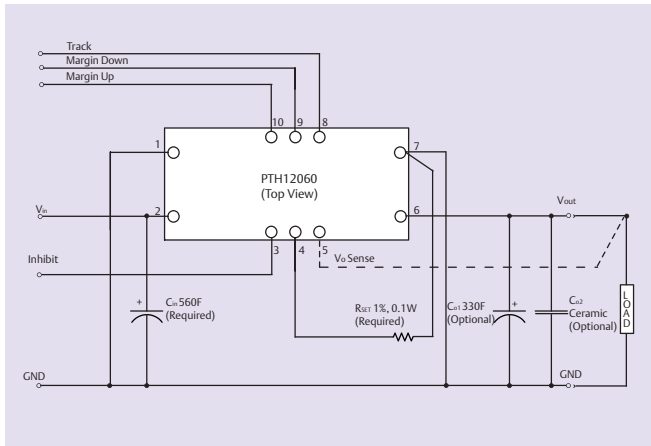

Figure 8 - Standard Application - All Models

Notes

- A SOA curves represent the conditions at which internal components are within the Emerson Network Power derating guidelines.
- B Characteristic data has been developed from actual products tested at 25 °C. This data is considered typical data for the converter.

Mechanical Drawings

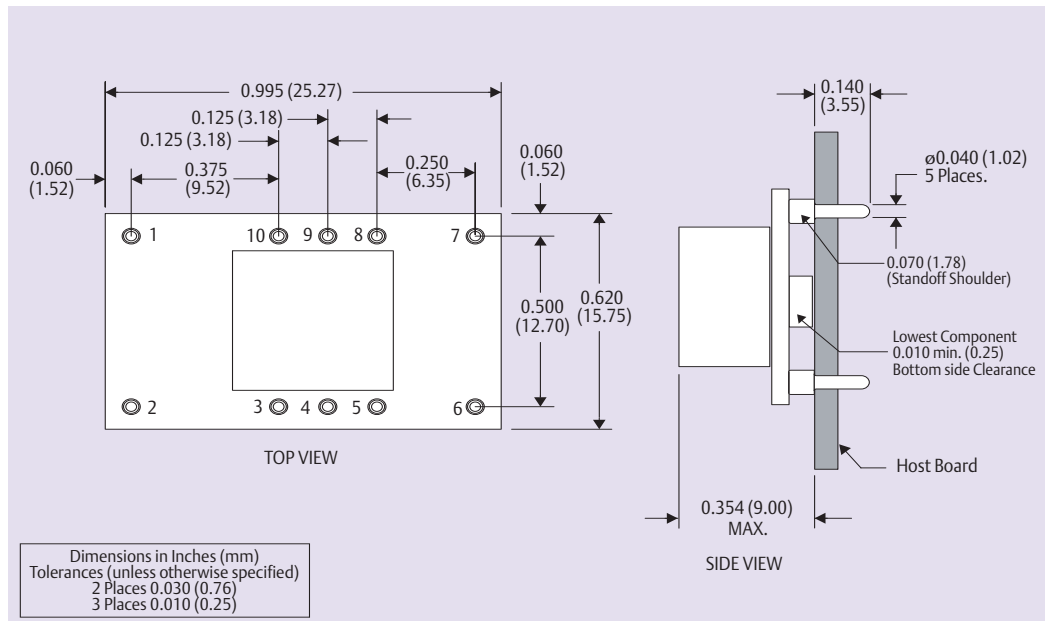

Figure 9 - Plated Through-Hole

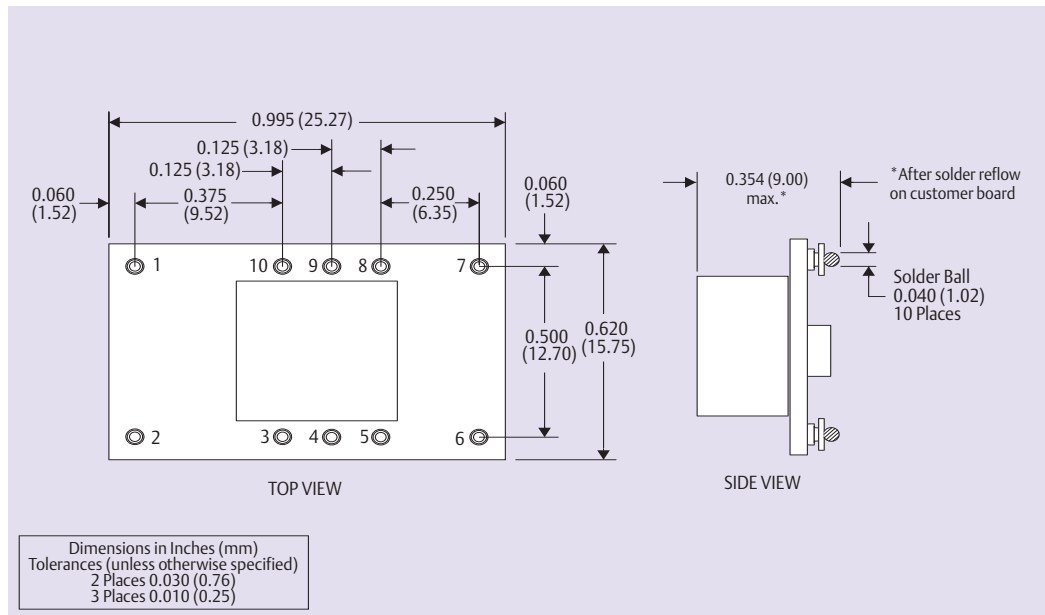

Figure 10 - Surface-Mount

Pin Connections	
Pin No.	Function
Pin 1	Ground
Pin 2	Vin
Pin 3	Inhibit*
Pin 4	Vo adjust
Pin 5	Vo sense

Pin Connections cont.	
Pin No.	Function
Pin 6	Vout
Pin 7	Ground
Pin 8	Track
Pin 9	Margin down*
Pin 10	Margin up*

*Denotes negative logic:
Open = Normal operation
Ground = Function active

Americas

5810 Van Allen Way
Carlsbad, CA 92008
USA
Telephone: +1 760 930 4600
Facsimile: +1 760 930 0698

Europe (UK)

Waterfront Business Park
Merry Hill, Dudley
West Midlands, DY5 1LX
United Kingdom
Telephone: +44 (0) 1384 842 211
Facsimile: +44 (0) 1384 843 355

Asia (HK)

14/F, Lu Plaza
2 Wing Yip Street
Kwun Tong, Kowloon
Hong Kong
Telephone: +852 2176 3333
Facsimile: +852 2176 3888

For global contact, visit:

www.PowerConversion.com
techsupport.embeddedpower@emerson.com

While every precaution has been taken to ensure accuracy and completeness in this literature, Emerson Network Power assumes no responsibility, and disclaims all liability for damages resulting from use of this information or for any errors or omissions.

Emerson Network Power.
The global leader in enabling business-critical continuity.

- AC Power
- Connectivity
- DC Power
- Embedded Computing
- Embedded Power
- Monitoring
- Outside Plant
- Power Switching & Controls
- Precision Cooling
- Racks & Integrated Cabinets
- Services
- Surge Protection

EmersonNetworkPower.com

Emerson Network Power and the Emerson Network Power logo are trademarks and service marks of Emerson Electric Co.
©2008 Emerson Electric Co.