

IRF9910PbF

HEXFET® Power MOSFET

Applications

- Dual SO-8 MOSFET for POL converters in desktop, servers, graphics cards, game consoles and set-top box
- Lead-Free

V_{DSS}	$R_{DS(on)}$ max	I_D
20V	Q1 13.4m Ω @ $V_{GS} = 10V$	10A
	Q2 9.3m Ω @ $V_{GS} = 10V$	12A

Benefits

- Very Low $R_{DS(on)}$ at 4.5V V_{GS}
- Low Gate Charge
- Fully Characterized Avalanche Voltage and Current
- 20V V_{GS} Max. Gate Rating

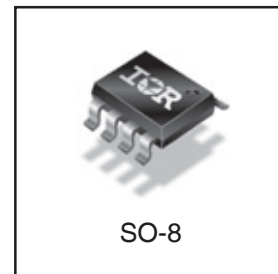
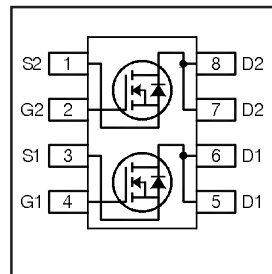

Absolute Maximum Ratings

	Parameter	Q1 Max.	Q2 Max.	Units
V_{DS}	Drain-to-Source Voltage	20		V
V_{GS}	Gate-to-Source Voltage	± 20		
$I_D @ T_A = 25^\circ C$	Continuous Drain Current, $V_{GS} @ 10V$	10	12	A
$I_D @ T_A = 70^\circ C$	Continuous Drain Current, $V_{GS} @ 10V$	8.3	9.9	
I_{DM}	Pulsed Drain Current ①	83	98	
$P_D @ T_A = 25^\circ C$	Power Dissipation	2.0		W
$P_D @ T_A = 70^\circ C$	Power Dissipation	1.3		
	Linear Derating Factor	0.016		W/ $^\circ C$
T_J	Operating Junction and	-55 to + 150		$^\circ C$
T_{STG}	Storage Temperature Range			

Thermal Resistance

	Parameter	Typ.	Max.	Units
$R_{\theta JL}$	Junction-to-Drain Lead	—	42	$^\circ C/W$
$R_{\theta JA}$	Junction-to-Ambient ④⑤	—	62.5	

Notes ① through ⑤ are on page 10

www.irf.com

1

07/23/08

IRF9910PbF

International
IR Rectifier

Static @ T_J = 25°C (unless otherwise specified)

	Parameter		Min.	Typ.	Max.	Units	Conditions		
BV _{DSS}	Drain-to-Source Breakdown Voltage	Q1&Q2	20	---	---	V	V _{GS} = 0V, I _D = 250μA		
ΔBV _{DSS} /ΔT _J	Breakdown Voltage Temp. Coefficient	Q1	---	0.0061	---	V/°C	Reference to 25°C, I _D = 1mA		
		Q2	---	0.014	---				
R _{DS(on)}	Static Drain-to-Source On-Resistance	Q1	---	10.7	13.4	mΩ	V _{GS} = 10V, I _D = 10A ③		
			---	14.6	18.3		V _{GS} = 4.5V, I _D = 8.3A ③		
		Q2	---	7.4	9.3		V _{GS} = 10V, I _D = 12A ③		
			---	9.1	11.3		V _{GS} = 4.5V, I _D = 9.8A ③		
V _{GS(th)}	Gate Threshold Voltage	Q1&Q2	1.65	---	2.55	V	V _{DS} = V _{GS} , I _D = 250μA		
ΔV _{GS(th)} /ΔT _J	Gate Threshold Voltage Coefficient	Q1	---	-4.9	---	mV/°C			
		Q2	---	-5.0	---				
I _{DSS}	Drain-to-Source Leakage Current	Q1&Q2	---	---	1.0	μA	V _{DS} = 16V, V _{GS} = 0V		
		Q1&Q2	---	---	100		V _{DS} = 16V, V _{GS} = 0V, T _J = 125°C		
I _{GSS}	Gate-to-Source Forward Leakage	Q1&Q2	---	---	100	nA	V _{GS} = 20V		
	Gate-to-Source Reverse Leakage	Q1&Q2	---	---	-100		V _{GS} = -20V		
g _{fs}	Forward Transconductance	Q1	19	---	---	S	V _{DS} = 10V, I _D = 8.3A		
		Q2	27	---	---		V _{DS} = 10V, I _D = 9.8A		
Q _g	Total Gate Charge	Q1	---	7.4	11	nC	Q1 V _{DS} = 10V V _{GS} = 4.5V, I _D = 8.3A Q2 V _{DS} = 10V V _{GS} = 4.5V, I _D = 9.8A		
		Q2	---	15	23				
Q _{gs1}	Pre-V _{th} Gate-to-Source Charge	Q1	---	2.6	---				
		Q2	---	4.3	---				
Q _{gs2}	Post-V _{th} Gate-to-Source Charge	Q1	---	0.85	---				
		Q2	---	1.4	---				
Q _{gd}	Gate-to-Drain Charge	Q1	---	2.5	---				
		Q2	---	5.4	---				
Q _{qodr}	Gate Charge Overdrive	Q1	---	1.5	---				
		Q2	---	3.9	---				
Q _{sw}	Switch Charge (Q _{gs2} + Q _{gd})	Q1	---	3.4	---				
		Q2	---	6.8	---				
Q _{oss}	Output Charge	Q1	---	4.0	---			nC	V _{DS} = 10V, V _{GS} = 0V
		Q2	---	8.7	---				
t _{d(on)}	Turn-On Delay Time	Q1	---	6.3	---	ns	Q1 V _{DD} = 16V, V _{GS} = 4.5V I _D = 8.3A Q2 V _{DD} = 16V, V _{GS} = 4.5V I _D = 9.8A Clamped Inductive Load		
		Q2	---	8.3	---				
t _r	Rise Time	Q1	---	10	---				
		Q2	---	14	---				
t _{d(off)}	Turn-Off Delay Time	Q1	---	9.2	---				
		Q2	---	15	---				
t _f	Fall Time	Q1	---	4.5	---				
		Q2	---	7.5	---				
C _{iss}	Input Capacitance	Q1	---	900	---			pF	V _{GS} = 0V V _{DS} = 10V f = 1.0MHz
		Q2	---	1860	---				
C _{oss}	Output Capacitance	Q1	---	290	---				
		Q2	---	600	---				
C _{rss}	Reverse Transfer Capacitance	Q1	---	140	---				
		Q2	---	310	---				

Avalanche Characteristics

	Parameter	Typ.	Q1 Max.	Q2 Max.	Units
E _{AS}	Single Pulse Avalanche Energy ②	---	33	26	mJ
I _{AR}	Avalanche Current ①	---	8.3	9.8	A

Diode Characteristics

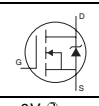
	Parameter		Min.	Typ.	Max.	Units	Conditions
I _S	Continuous Source Current (Body Diode)	Q1&Q2	---	---	2.5	A	MOSFET symbol showing the integral reverse p-n junction diode. 
I _{SM}	Pulsed Source Current (Body Diode) ①	Q1	---	---	83	A	
		Q2	---	---	98		
V _{SD}	Diode Forward Voltage	Q1	---	---	1.0	V	T _J = 25°C, I _S = 8.3A, V _{GS} = 0V ③
		Q2	---	---	1.0		T _J = 25°C, I _S = 9.8A, V _{GS} = 0V ③
t _{rr}	Reverse Recovery Time	Q1	---	11	17	ns	Q1 T _J = 25°C, I _F = 8.3A, V _{DD} = 10V, di/dt = 100A/μs ③
		Q2	---	16	24		
Q _{rr}	Reverse Recovery Charge	Q1	---	3.1	4.7	nC	Q2 T _J = 25°C, I _F = 9.8A, V _{DD} = 10V, di/dt = 100A/μs ③
		Q2	---	4.9	7.3		

Q1 - Control FET

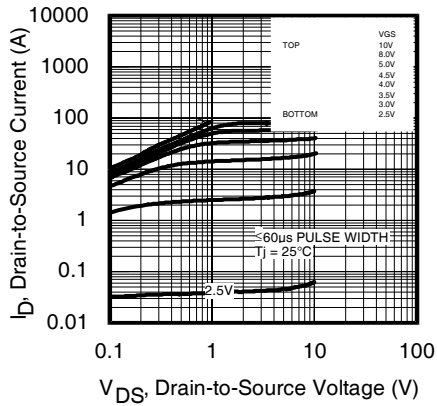

Fig 1. Typical Output Characteristics

Q2 - Synchronous FET

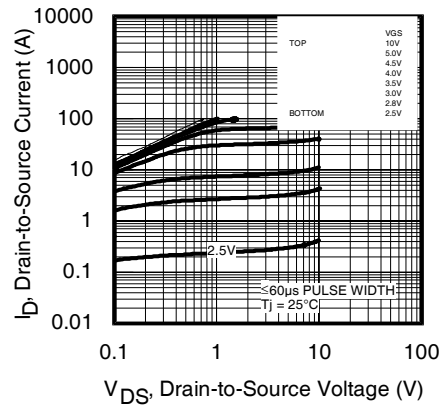

Fig 2. Typical Output Characteristics

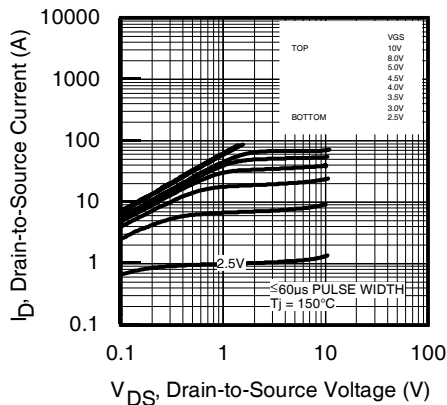

Fig 3. Typical Output Characteristics

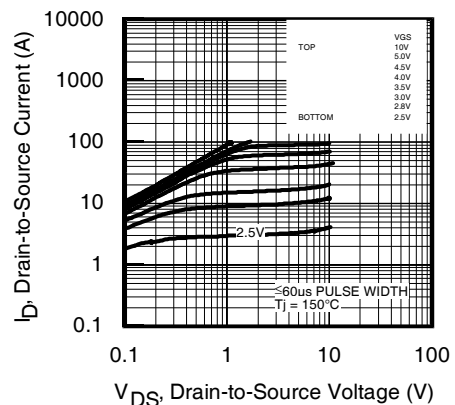

Fig 4. Typical Output Characteristics

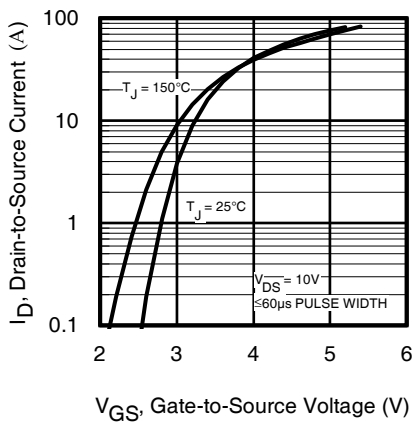

Fig 5. Typical Transfer Characteristics

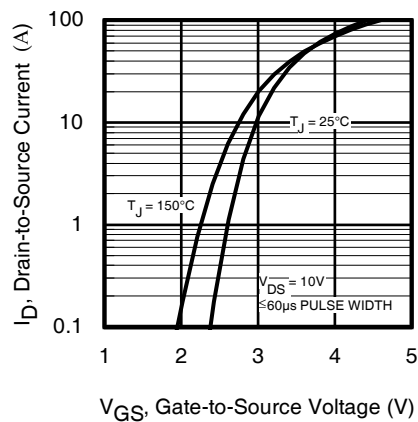

Fig 6. Typical Transfer Characteristics

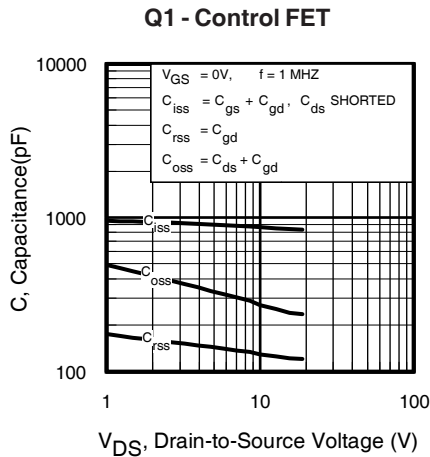

Fig 7. Typical Capacitance Vs.Drain-to-Source Voltage

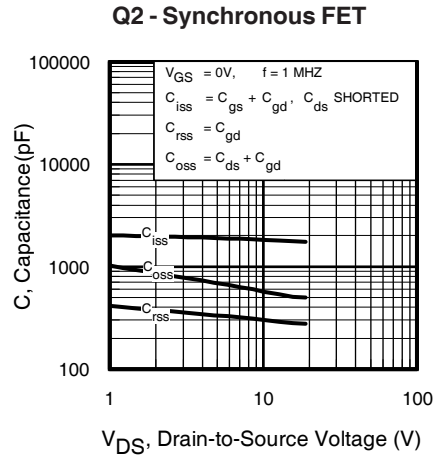

Fig 8. Typical Capacitance Vs.Drain-to-Source Voltage

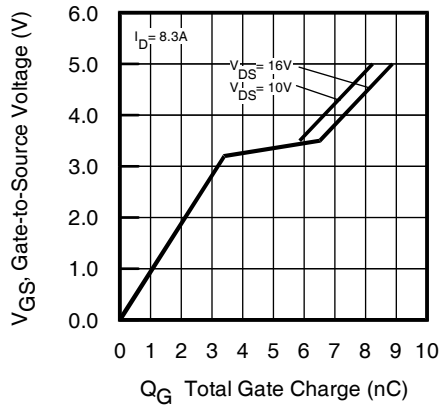

Fig 9. Gate-to-Source Voltage vs Typical Gate Charge

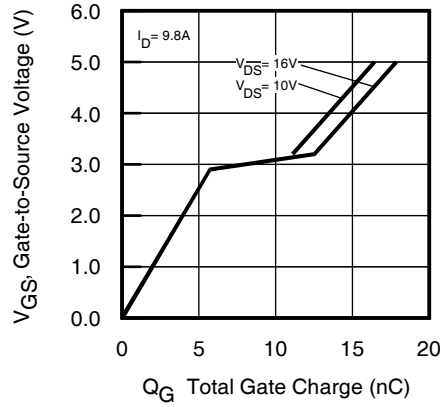

Fig 10. Gate-to-Source Voltage vs Typical Gate Charge

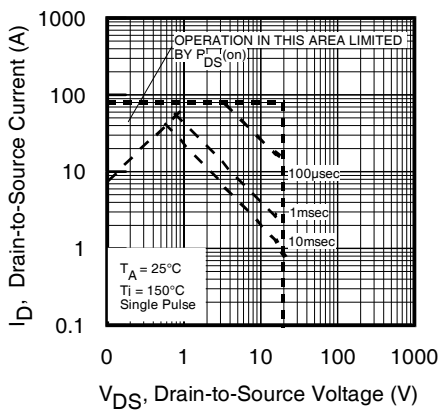

Fig 11. Maximum Safe Operating Area

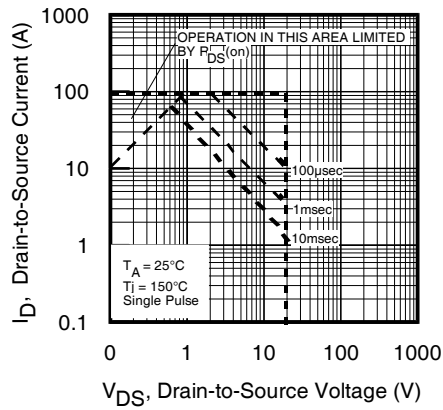

Fig 12. Maximum Safe Operating Area

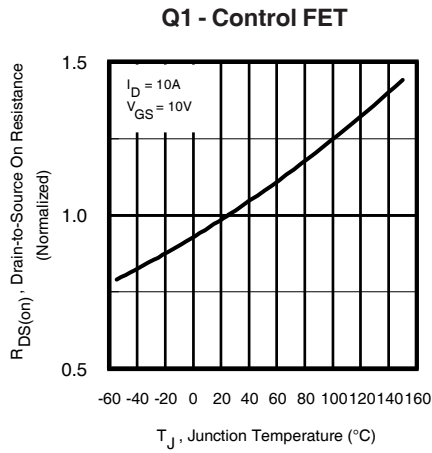

Fig 13. Normalized On-Resistance vs. Temperature

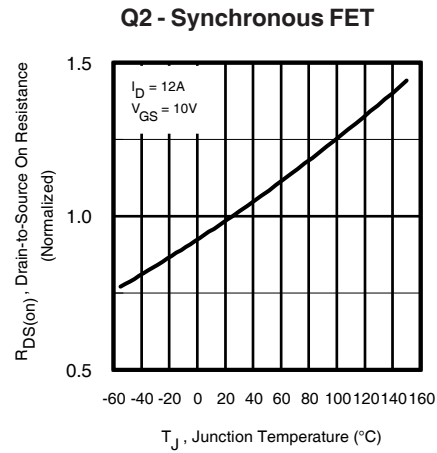

Fig 14. Normalized On-Resistance vs. Temperature

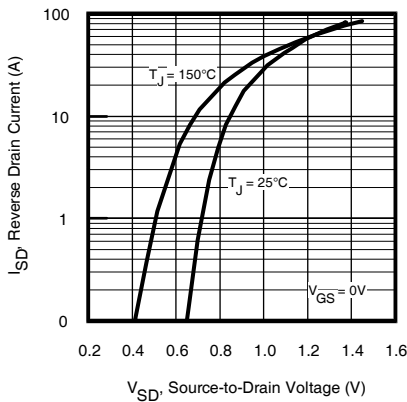

Fig 15. Typical Source-Drain Diode Forward Voltage

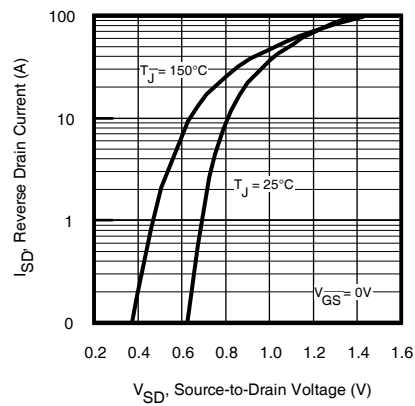

Fig 16. Typical Source-Drain Diode Forward Voltage

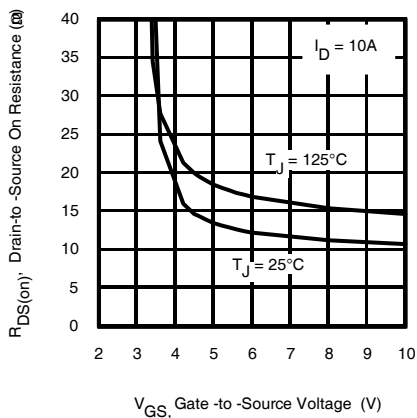

Fig 17. Typical On-Resistance vs. Gate Voltage

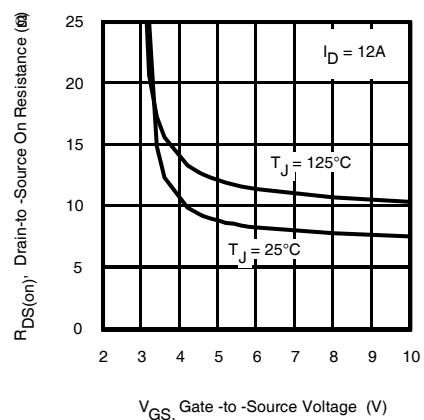

Fig 18. Typical On-Resistance vs. Gate Voltage

Q1 - Control FET

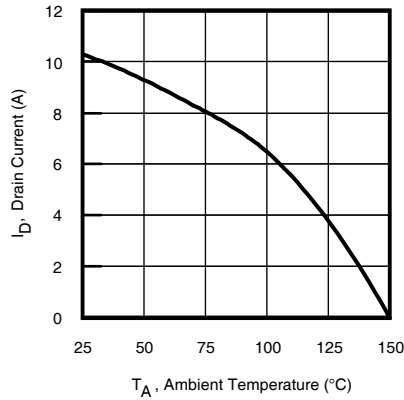

Fig 19. Maximum Drain Current vs. Ambient Temperature

Q2 - Synchronous FET

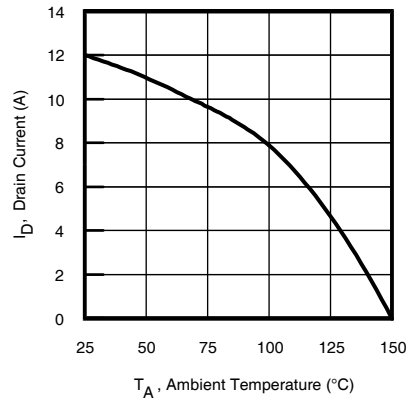

Fig 20. Maximum Drain Current vs. Ambient Temperature

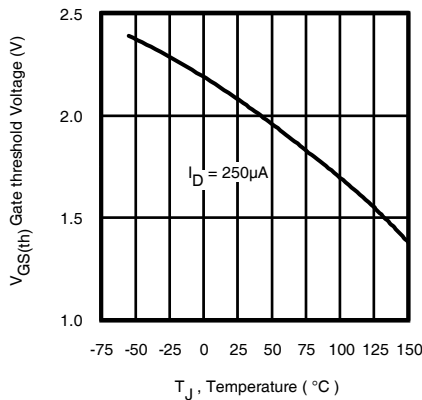

Fig 21. Threshold Voltage vs. Temperature

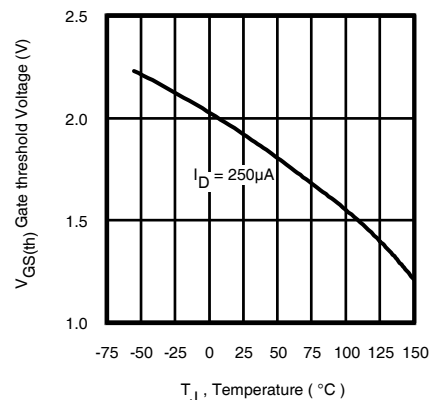

Fig 22. Threshold Voltage vs. Temperature

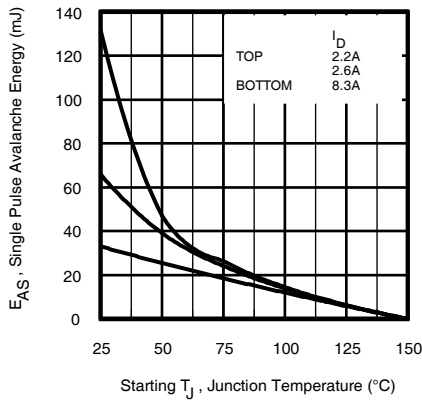

Fig 23. Maximum Avalanche Energy vs. Drain Current

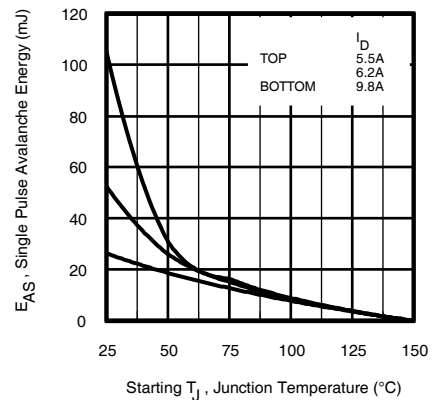

Fig 24. Maximum Avalanche Energy vs. Drain Current

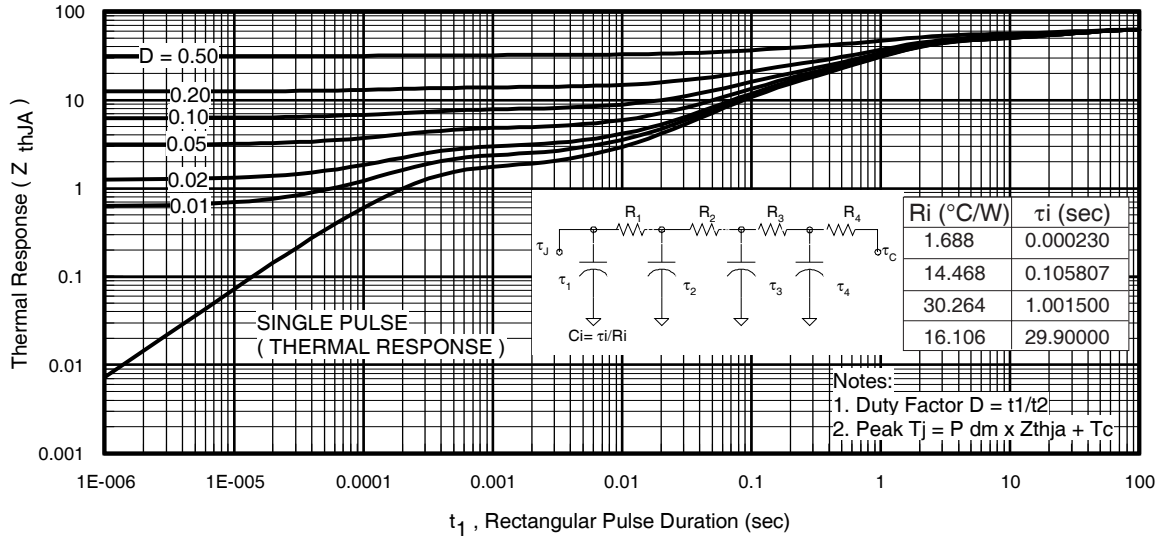

Fig 25. Maximum Effective Transient Thermal Impedance, Junction-to-Ambient

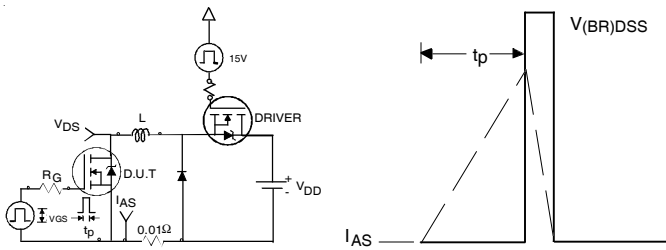

Fig 26. Unclamped Inductive Test Circuit and Waveform

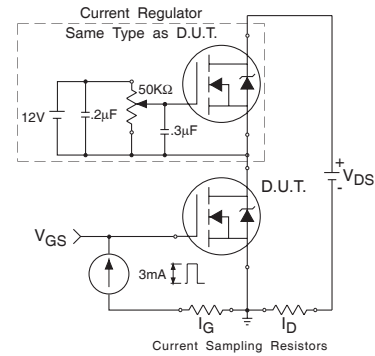

Fig 27. Gate Charge Test Circuit

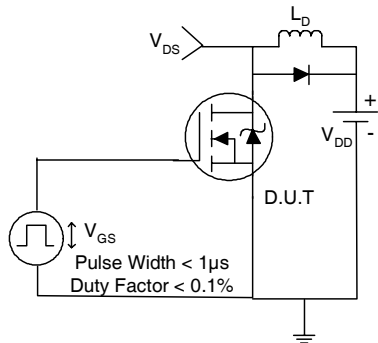

Fig 28. Switching Time Test Circuit

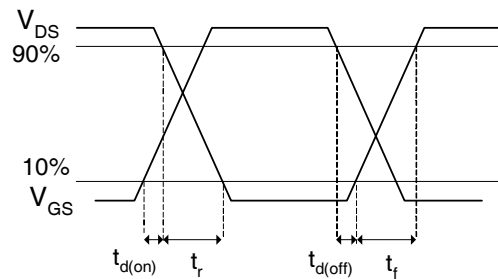

Fig 29. Switching Time Waveforms

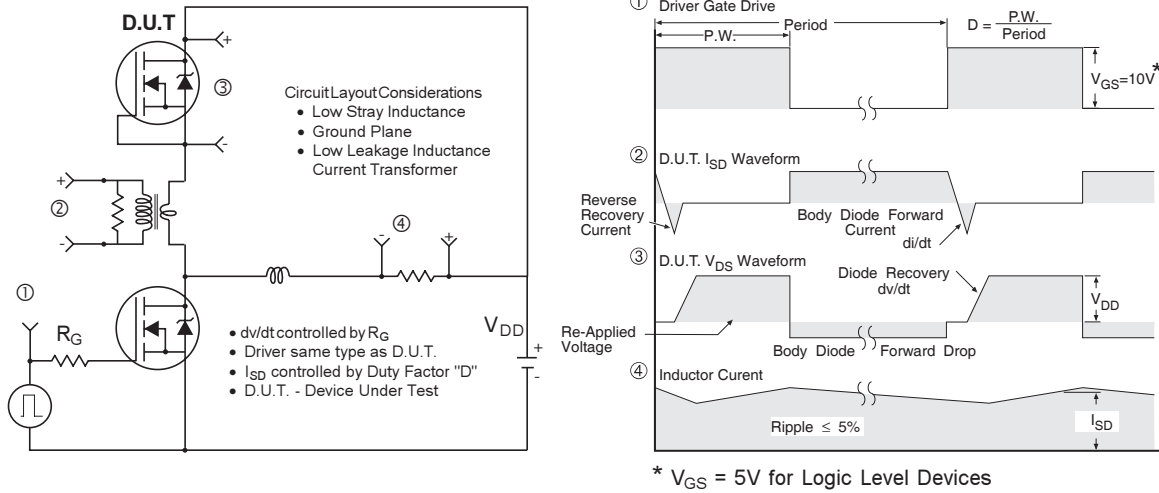

Fig 30. Peak Diode Recovery dv/dt Test Circuit for N-Channel HEXFET® Power MOSFETs

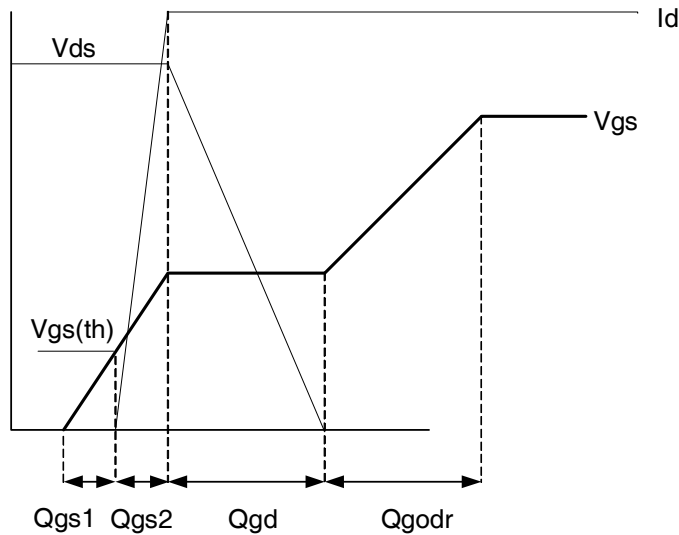
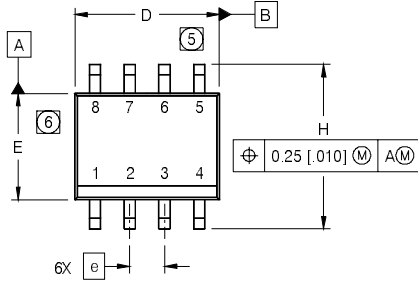

Fig 31. Gate Charge Waveform

SO-8 Package Outline (MOSFET & Fetky)

Dimensions are shown in millimeters (inches)



DIM	INCHES		MILLIMETERS	
	MIN	MAX	MIN	MAX
A	.0532	.0688	1.35	1.75
A1	.0040	.0098	0.10	0.25
b	.013	.020	0.33	0.51
c	.0075	.0098	0.19	0.25
D	.189	.1968	4.80	5.00
E	.1497	.1574	3.80	4.00
e	.050 BASIC		1.27 BASIC	
e1	.025 BASIC		0.635 BASIC	
H	.2284	.2440	5.80	6.20
K	.0099	.0196	0.25	0.50
L	.016	.050	0.40	1.27
y	0°	8°	0°	8°

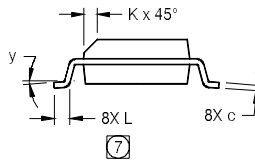
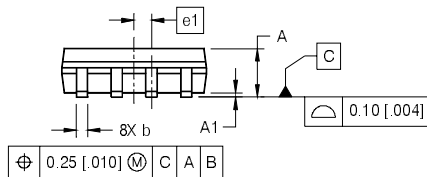

NOTES:

1. DIMENSIONING & TOLERANCING PER ASME Y14.5M-1994.
2. CONTROLLING DIMENSION: MILLIMETER
3. DIMENSIONS ARE SHOWN IN MILLIMETERS [INCHES].
4. OUTLINE CONFORMS TO JEDEC OUTLINE MS-012AA.
- ⑤ DIMENSION DOES NOT INCLUDE MOLD PROTRUSIONS. MOLD PROTRUSIONS NOT TO EXCEED 0.15 [0.006].
- ⑥ DIMENSION DOES NOT INCLUDE MOLD PROTRUSIONS. MOLD PROTRUSIONS NOT TO EXCEED 0.25 [0.010].
- ⑦ DIMENSION IS THE LENGTH OF LEAD FOR SOLDERING TO A SUBSTRATE.

FOOTPRINT

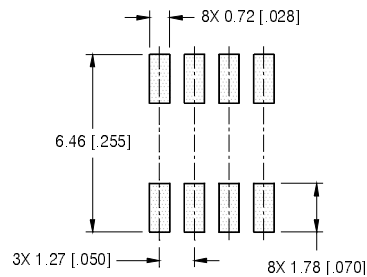

SO-8 Part Marking Information

EXAMPLE: THIS IS AN IRF7101 (MOSFET)

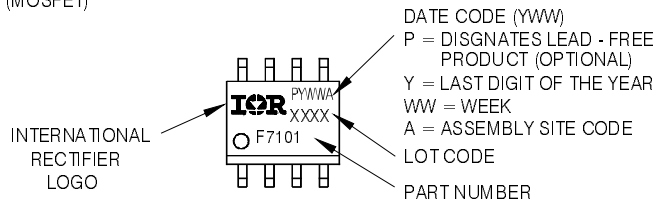

Note: For the most current drawing please refer to IR website at: <http://www.irf.com/package/>

IRF9910PbF

SO-8 Tape and Reel

International
IR Rectifier

Dimensions are shown in millimeters (inches)

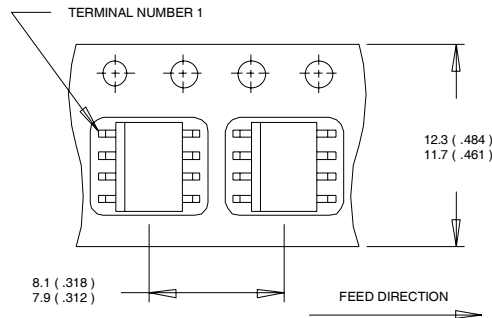

- NOTES:
1. CONTROLLING DIMENSION : MILLIMETER.
 2. ALL DIMENSIONS ARE SHOWN IN MILLIMETERS(INCHES).
 3. OUTLINE CONFORMS TO EIA-481 & EIA-541.

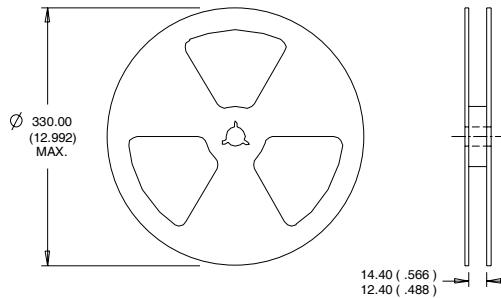

- NOTES:
1. CONTROLLING DIMENSION : MILLIMETER.
 2. OUTLINE CONFORMS TO EIA-481 & EIA-541.

Note: For the most current drawing please refer to IR website at: <http://www.irf.com/package/>

Notes:

- ① Repetitive rating; pulse width limited by max. junction temperature.
- ② Starting $T_J = 25^\circ\text{C}$, Q1: $L = 0.95\text{mH}$
 $R_G = 25\Omega$, $I_{AS} = 8.3\text{A}$; Q2: $L = 0.54\text{mH}$
 $R_G = 25\Omega$, $I_{AS} = 9.8\text{A}$.
- ③ Pulse width $\leq 400\mu\text{s}$; duty cycle $\leq 2\%$.
- ④ When mounted on 1 inch square copper board.
- ⑤ R_θ is measured at T_J approximately 90°C .

Data and specifications subject to change without notice.
This product has been designed and qualified for the Consumer market.
Qualifications Standards can be found on IR's Web site.

International
IR Rectifier

IR WORLD HEADQUARTERS: 233 Kansas St., El Segundo, California 90245, USA Tel: (310) 252-7105
TAC Fax: (310) 252-7903

Visit us at www.irf.com for sales contact information.07/2008

www.irf.com

IMPORTANT NOTICE

The information given in this document shall in no event be regarded as a guarantee of conditions or characteristics ("Beschaffheitsgarantie").

With respect to any examples, hints or any typical values stated herein and/or any information regarding the application of the product, Infineon Technologies hereby disclaims any and all warranties and liabilities of any kind, including without limitation warranties of non-infringement of intellectual property rights of any third party.

In addition, any information given in this document is subject to customer's compliance with its obligations stated in this document and any applicable legal requirements, norms and standards concerning customer's products and any use of the product of Infineon Technologies in customer's applications.

The data contained in this document is exclusively intended for technically trained staff. It is the responsibility of customer's technical departments to evaluate the suitability of the product for the intended application and the completeness of the product information given in this document with respect to such application.

For further information on the product, technology, delivery terms and conditions and prices please contact your nearest Infineon Technologies office (www.infineon.com).

WARNINGS

Due to technical requirements products may contain dangerous substances. For information on the types in question please contact your nearest Infineon Technologies office.

Except as otherwise explicitly approved by Infineon Technologies in a written document signed by authorized representatives of Infineon Technologies, Infineon Technologies' products may not be used in any applications where a failure of the product or any consequences of the use thereof can reasonably be expected to result in personal injury.