

RL78/G1C

R01DS0348EJ0121

RENESAS MCU

Rev.1.21

Dec 22, 2020

Integrated USB Controller, True Low Power Platform (as low as 112.5 $\mu\text{A}/\text{MHz}$, and 0.61 μA for RTC + LVD), 2.4 V to 5.5 V Operation, 32 Kbyte Flash, 31 DMIPS at 24 MHz, for All USB Based Applications

1. OUTLINE
1.1 Features
Ultra-Low Power Technology

- 2.4 V to 5.5 V operation from a single supply
- Stop (RAM retained): 0.23 μA , (LVD enabled): 0.31 μA
- Halt (RTC + LVD): 0.57 μA
- Supports snooze
- Operating: 71 $\mu\text{A}/\text{MHz}$

16-bit RL78 CPU Core

- Delivers 31 DMIPS at maximum operating frequency of 24 MHz
- Instruction Execution: 86% of instructions can be executed in 1 to 2 clock cycles
- CISC Architecture (Harvard) with 3-stage pipeline
- Multiply Signed & Unsigned: 16 x 16 to 32-bit result in 1 clock cycle
- MAC: 16 x 16 to 32-bit result in 2 clock cycles
- 16-bit barrel shifter for shift & rotate in 1 clock cycle
- 1-wire on-chip debug function

Code Flash Memory

- Density: 32 KB
- Block size: 1 KB
- On-chip single voltage flash memory with protection from block erase/writing
- Self-programming with secure boot swap function and flash shield window function

Data Flash Memory

- Data Flash with background operation
- Data flash size: 2 KB
- Erase Cycles: 1 Million (typ.)
- Erase/programming voltage: 2.4 V to 5.5 V

RAM

- 5.5 KB size options
- Supports operands or instructions
- Back-up retention in all modes

High-speed On-chip Oscillator

- 24 MHz with +/- 1% accuracy over voltage (2.4 V to 5.5 V) and temperature (-20°C to +85°C)
- Pre-configured settings: 48 MHz, 24 MHz (TYP.)

Reset and Supply Management

- Power-on reset (POR) monitor/generator
- Low voltage detection (LVD) with 9 setting options (Interrupt and/or reset function)

USB

- Complying with USB version 2.0, incorporating host/function controller
- Corresponding to full-speed transfer (12 Mbps) and low-speed (1.5 Mbps)
- Complying with Battery Charging Specification Revision 1.2
- Compliant with the 2.1A/1.0A charging mode prescribed in the Apple Inc. MFi specification in the USB power supply component specification ^{Note}

Direct Memory Access (DMA) Controller

- Up to 2 fully programmable channels
- Transfer unit: 8- or 16-bit

Multiple Communication Interfaces

- Up to 2 x I²C master
- Up to 1 x I²C multi-master
- Up to 2 x CSI (7-, 8-bit)
- Up to 1 x UART (7-, 8-, 9-bit)

Extended-Function Timers

- Multi-function 16-bit timer TAU: Up to 4 channels (remote control output available)
- Real-time clock (RTC): 1 channel (full calendar and alarm function with watch correction function)
- 12-bit interval timer: 1 channel
- 15 kHz watchdog timer: 1 channel (window function)

Rich Analog

- ADC: Up to 9 channels, 8/10-bit resolution, 2.1 μs minimum conversion time
- Internal voltage reference (1.45 V)
- On-chip temperature sensor

Safety Features (IEC or UL 60730 compliance)

- Flash memory CRC calculation
- RAM parity error check
- RAM write protection
- SFR write protection
- Illegal memory access detection
- Clock stop/frequency detection
- ADC self-test
- I/O port read back function (echo)

General Purpose I/O

- 5 V tolerant, high-current (up to 20 mA per pin)
- Open-Drain, Internal Pull-up support

Operating Ambient Temperature

- Standard: -40°C to + 85°C
- Extended: -40°C to + 105°C

Package Type and Pin Count

- 32-pin plastic HWQFN (5 x 5)
- 32-pin plastic LQFP (7 x 7)
- 48-pin plastic LFQFP (7 x 7)
- 48-pin plastic HWQFN (7 x 7)

Note To use the Apple Inc. battery charging mode, you must join in Apple's Made for iPod/iPhone/iPad (MFi) licensing program. Before requesting this specification from Renesas Electronics, please join in the Apple's MFi licensing program.

ROM, RAM capacities

| Flash ROM | Data flash | RAM | RL78/G1C | |
|-----------|------------|------------------------|--------------------|--------------------|
| | | | 32-pin | 48-pin |
| 32 KB | 2 KB | 5.5 KB ^{Note} | R5F10JBC, R5F10KBC | R5F10JGC, R5F10KGC |

Note This is about 4.5 KB when the self-programming function is used.

Remark The functions mounted depend on the product. See **1.6 Outline of Functions**.

1.2 List of Part Numbers

Table 1-1. List of Ordering Part Numbers

<R>

| Pin count | Package | USB Function | Fields of Application <small>Note</small> | Part Number | | RENESAS Code |
|--------------------------|---|--------------------------|--|--------------|-------------------------|--------------|
| | | | | Part Number | Packaging specification | |
| 32 pins | 32-pin plastic HWQFN (5 × 5, 0.5 mm pitch) | Host/Function controller | A | R5F10JBCANA | #U0, #W0 | PWQN0032KB-A |
| | | | | | #00, #20, #40 | PWQN0032KE-A |
| | | Function controller only | G | R5F10JBCGNA | #U0, #W0 | PWQN0032KB-A |
| | | | | | #00, #20, #40 | PWQN0032KE-A |
| | | Function controller only | A | R5F10KBCANA | #U0, #W0 | PWQN0032KB-A |
| | | | | | #00, #20, #40 | PWQN0032KE-A |
| | 32-pin plastic LQFP (7 × 7, 0.8 mm pitch) | Host/Function controller | A | R5F10JBCAFP | #V0, #X0 | PLQP0032GB-A |
| | | | G | R5F10JBCGFP | | |
| | | Function controller only | A | R5F10KBCAFP | | |
| | | | G | R5F10KBCGFP | | |
| 48 pins | 48-pin plastic LFQFP (7 × 7, 0.5 mm pitch) | Host/Function controller | A | R5F10JGCAFB | #V0, #X0 | PLQP0048KF-A |
| | | | G | R5F10JGCGFB | | |
| | | Function controller only | A | R5F10KGCAFB | | |
| | | | G | R5F10KGCGBFB | | |
| | 48-pin plastic HWQFN (7 × 7, 0.5 mm pitch) | Host/Function controller | A | R5F10JGCANA | #U0, #W0 | PWQN0048KB-A |
| | | | | | #00, #20, #40 | PWQN0048KE-A |
| | | Function controller only | G | R5F10JGCGNA | #U0, #W0 | PWQN0048KB-A |
| | | | | | #00, #20, #40 | PWQN0048KE-A |
| | | Function controller only | A | R5F10KGCANA | #U0, #W0 | PWQN0048KB-A |
| | | | | | #00, #20, #40 | PWQN0048KE-A |
| Function controller only | G | R5F10KGCGBNA | #U0, #W0 | PWQN0048KB-A | | |
| | | | #00, #20, #40 | PWQN0048KE-A | | |

Note For the fields of application, refer to **Figure 1-1 Part Number, Memory Size, and Package of RL78/G1C**.

Caution The part number above is valid as of when this manual was issued. For the latest part number, see the web page of the target product on the Renesas Electronics website.

Figure 1-1. Part Number, Memory Size, and Package of RL78/G1C

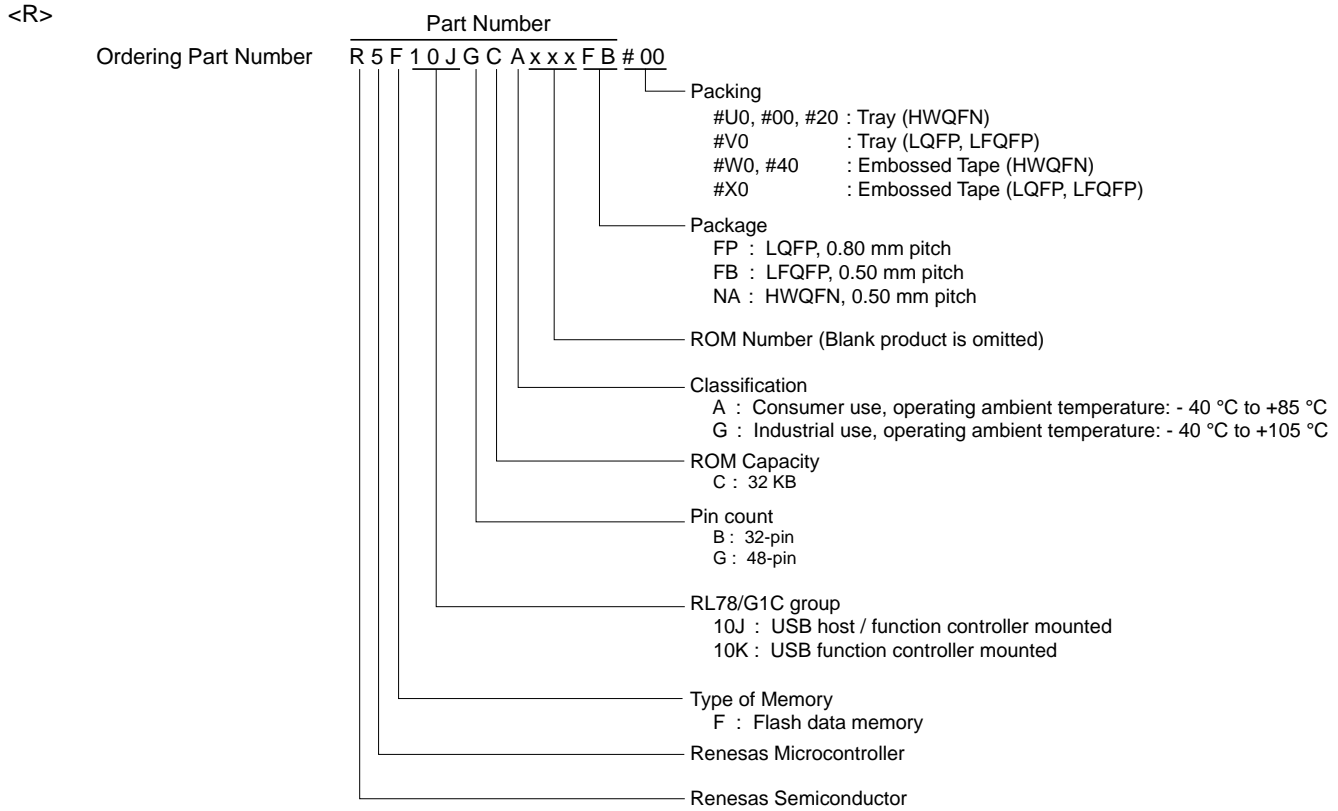

1.3 Pin Configuration (Top View)

1.3.1 32-pin products

- 32-pin plastic HWQFN (5 × 5 mm, 0.5 mm pitch)

(1) USB function: Host/Function controller (R5F10JBC)

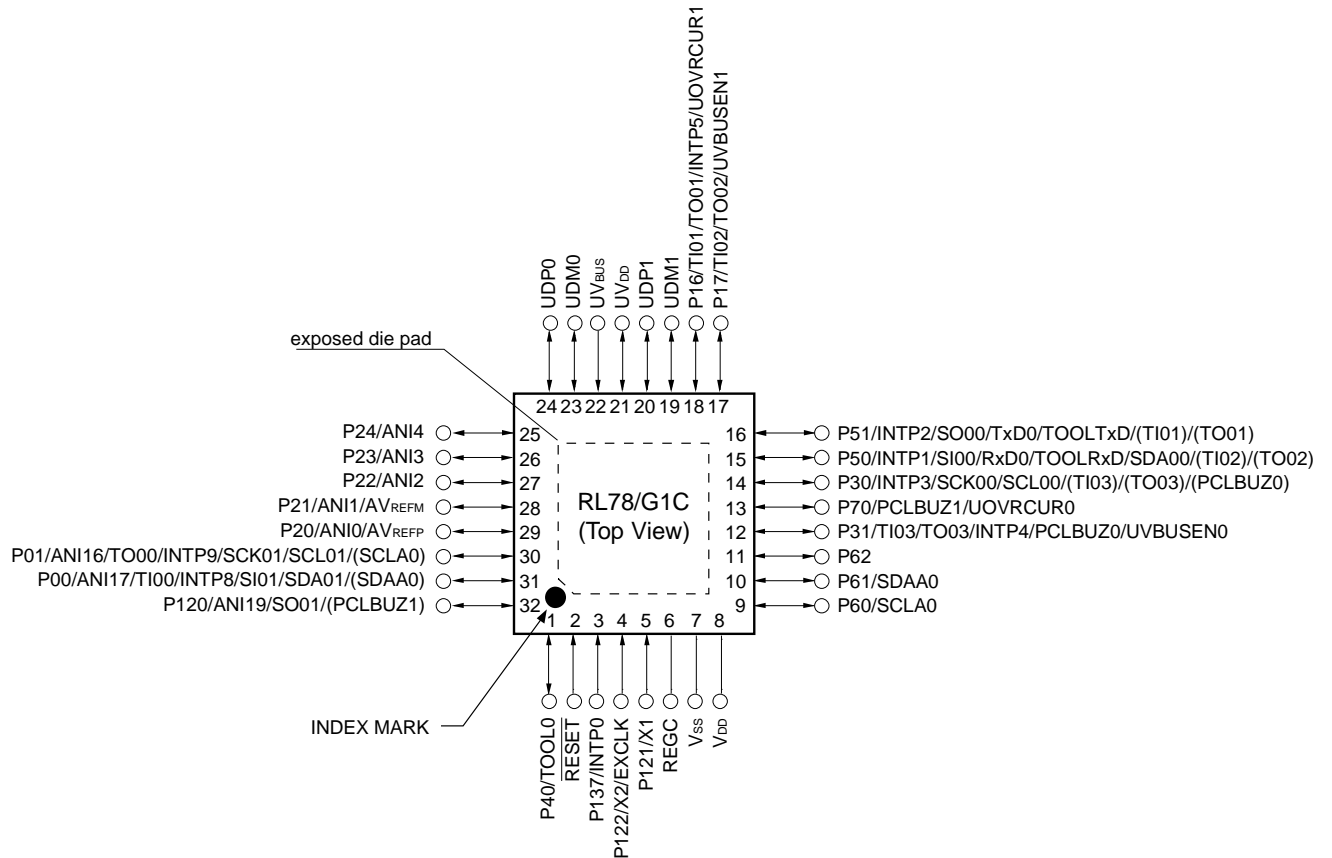

Caution Connect the REGC pin to V_{SS} via a capacitor (0.47 to 1 μF).

Remarks 1. For pin identification, see 1.4 Pin Identification.

2. Functions in parentheses in the above figure can be assigned via settings in the peripheral I/O redirection register (PIOR).
3. It is recommended to connect an exposed die pad to V_{SS}.

(2) USB function: Function controller only (R5F10KBC)

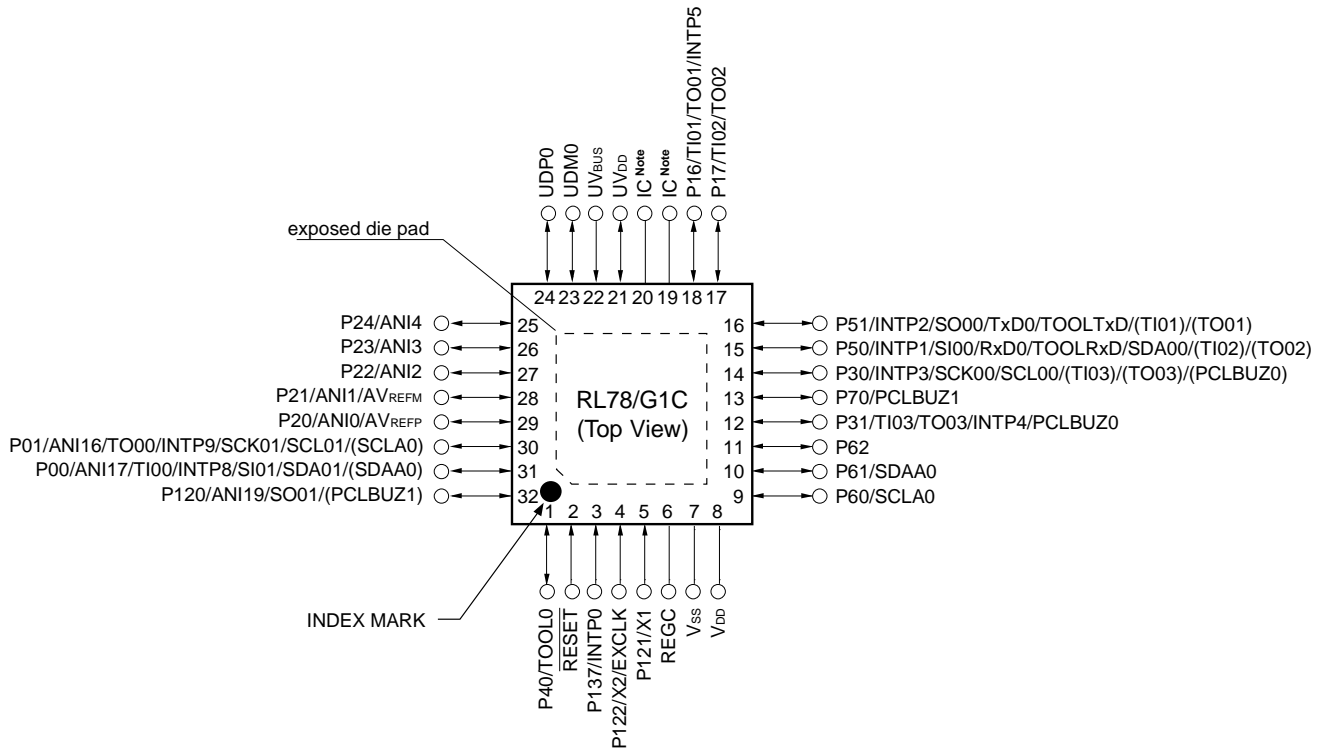

Note IC: Internal Connection Pin. Leave open.

Caution Connect the REGC pin to Vss via a capacitor (0.47 to 1 μ F).

Remarks 1. For pin identification, see 1.4 Pin Identification.

2. Functions in parentheses in the above figure can be assigned via settings in the peripheral I/O redirection register (PIOR).

3. It is recommended to connect an exposed die pad to Vss.

- 32-pin plastic LQFP (7 × 7 mm, 0.8 mm pitch)

(1) USB function: Host/Function controller (R5F10JBC)

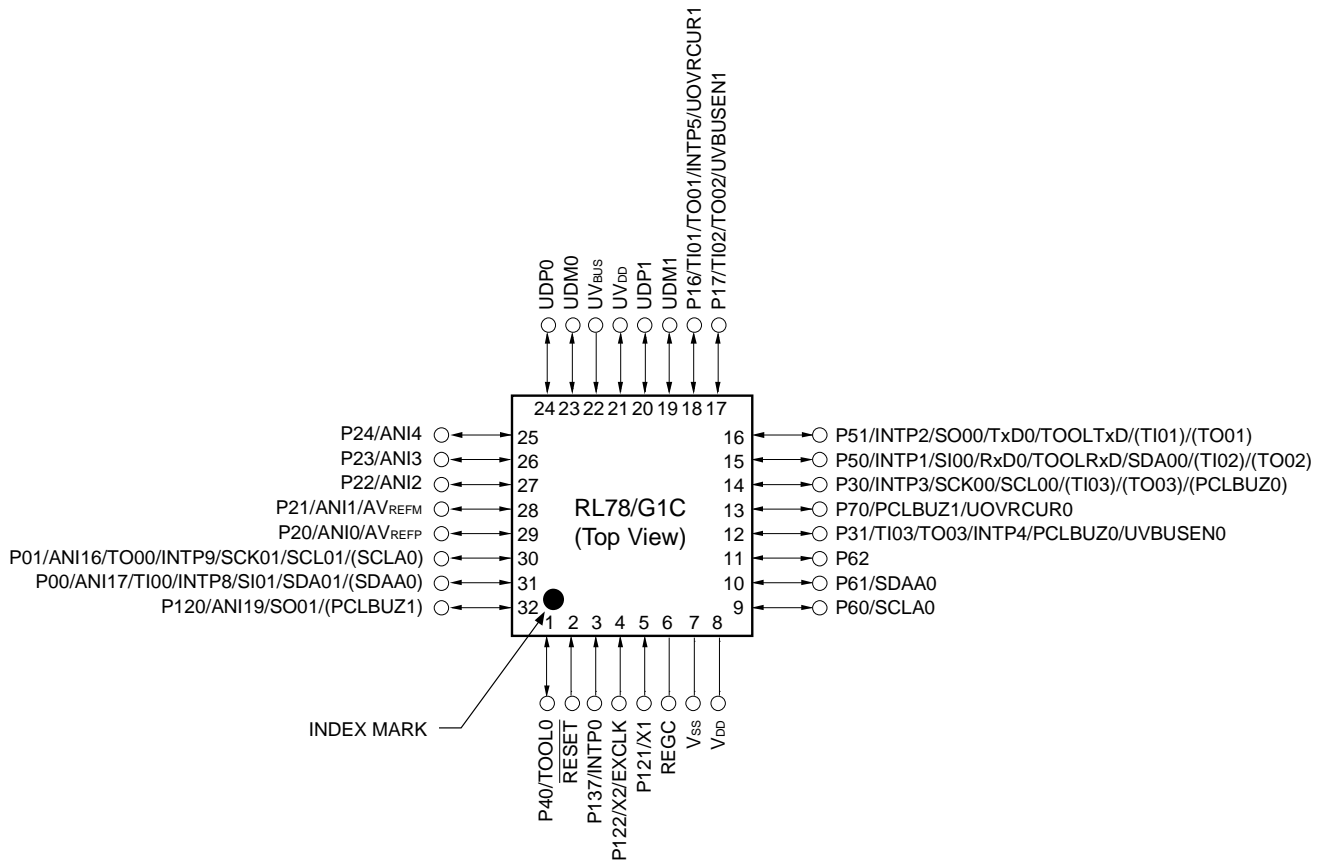

Caution Connect the REGC pin to V_{SS} via a capacitor (0.47 to 1 μF).

Remarks 1. For pin identification, see 1.4 Pin Identification.

2. Functions in parentheses in the above figure can be assigned via settings in the peripheral I/O redirection register (PIOR).

(2) USB function: Function controller only (R5F10KBC)

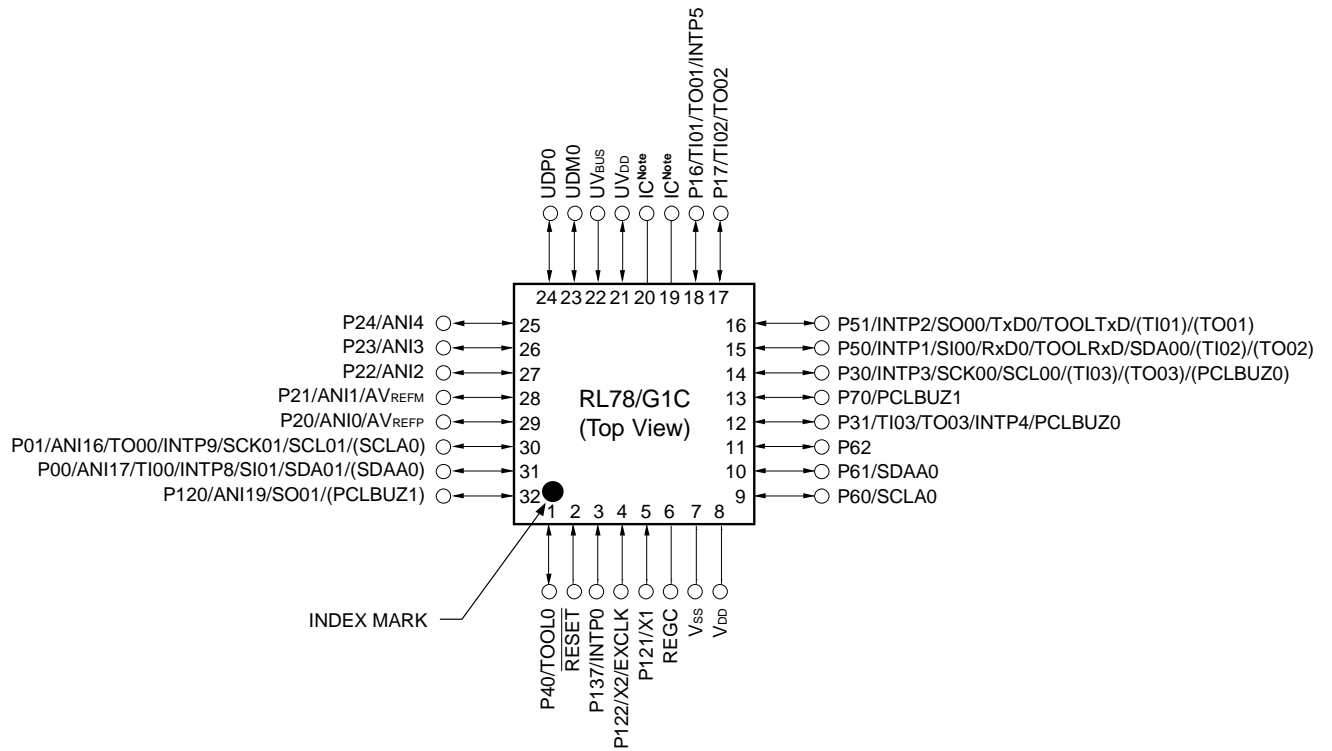

Note IC: Internal Connection Pin Leave open.

Caution Connect the REGC pin to Vss via a capacitor (0.47 to 1 μ F).

Remarks 1. For pin identification, see 1.4 Pin Identification.

2. Functions in parentheses in the above figure can be assigned via settings in the peripheral I/O redirection register (PIOR).

1.3.2 48-pin products

- 48-pin plastic LQFP (fine pitch) (7 × 7, 0.5 mm pitch)

(1) USB function: Host/Function controller (R5F10JGC)

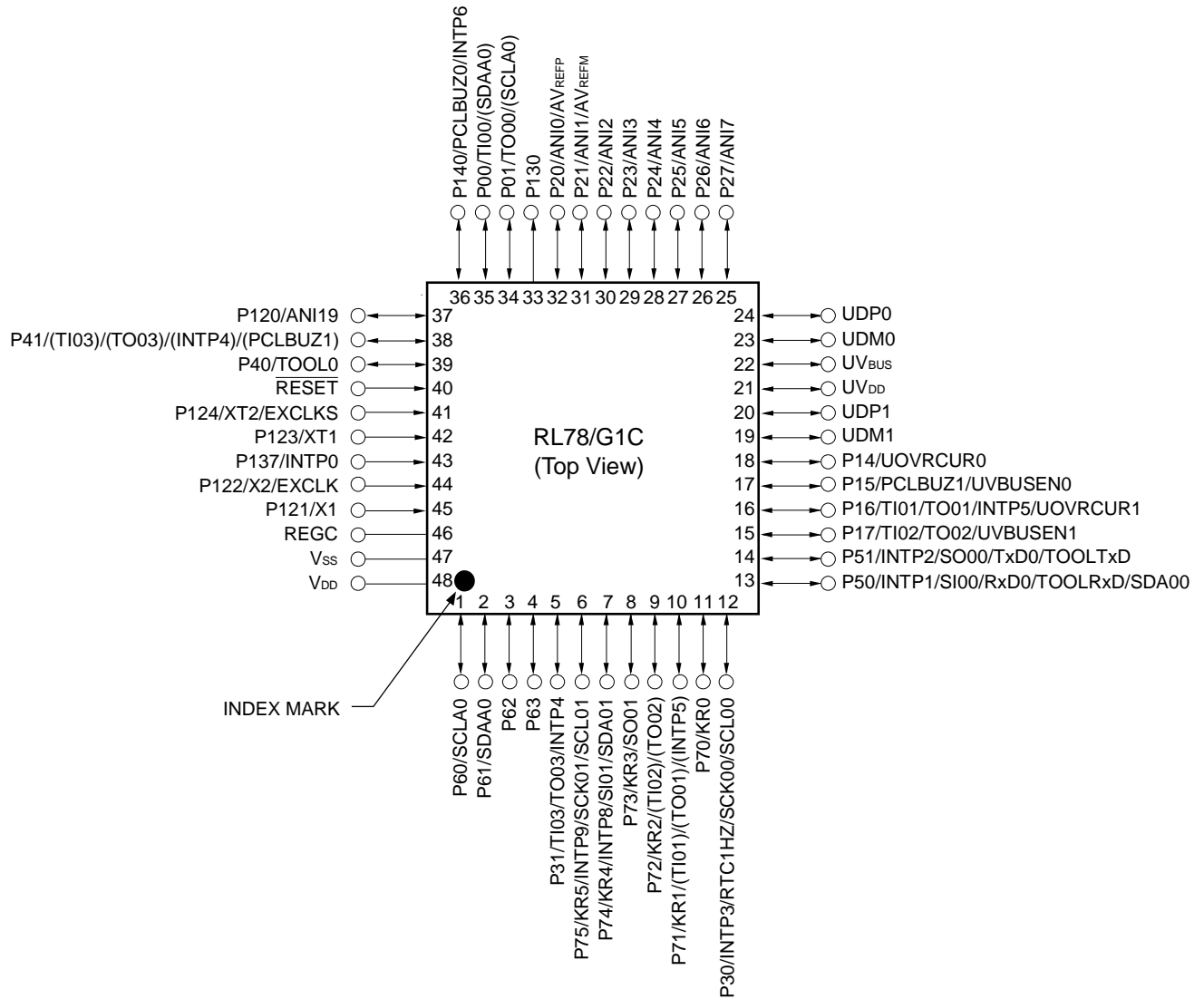

Caution Connect the REGC pin to V_{SS} via a capacitor (0.47 to 1 μF).

Remarks 1. For pin identification, see 1.4 Pin Identification.

2. Functions in parentheses in the above figure can be assigned via settings in the peripheral I/O redirection register (PIOR).

(2) USB function: Function controller only (R5F10KGC)

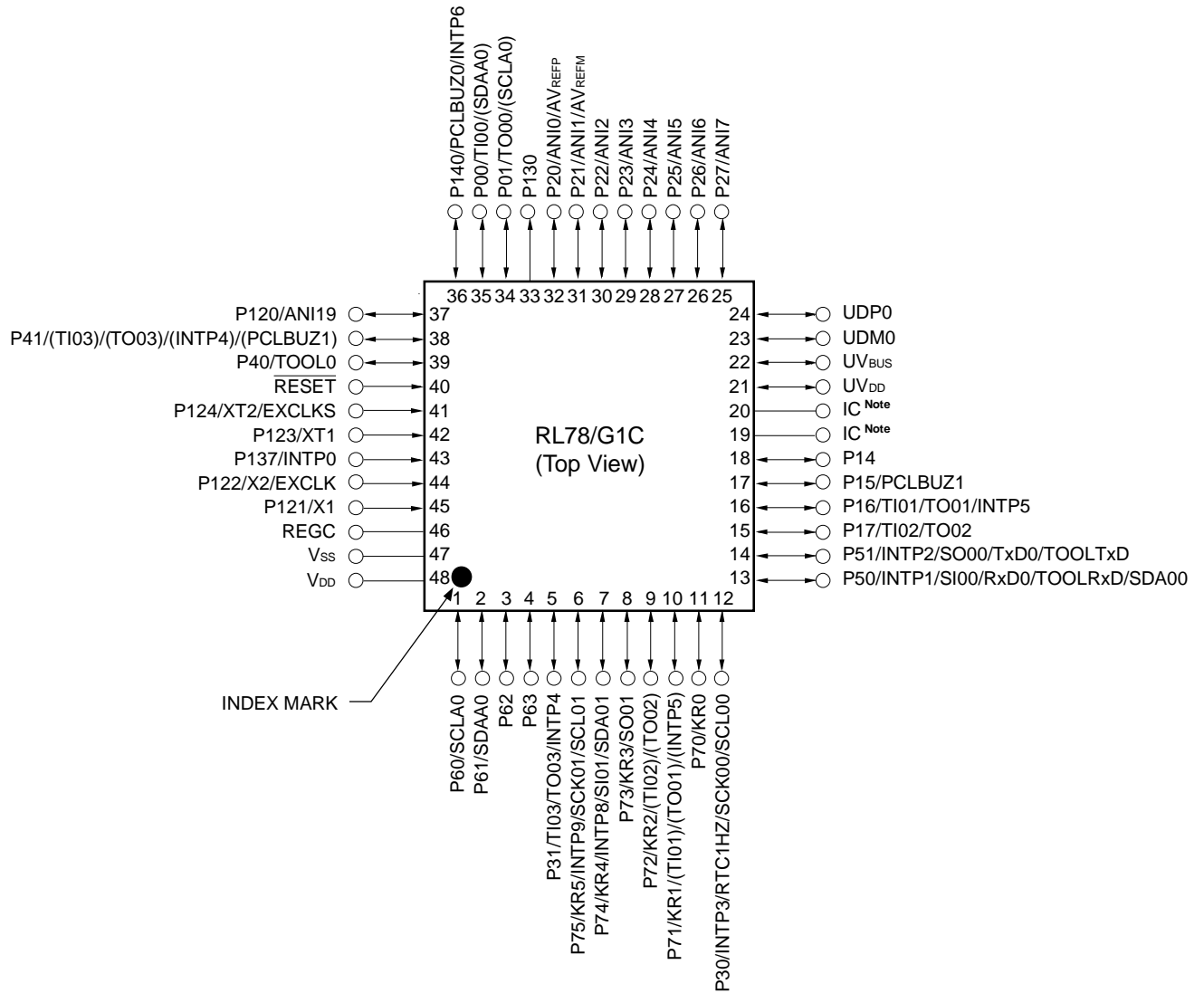

Note IC: Internal Connection Pin Leave open.

Caution Connect the REGC pin to Vss via a capacitor (0.47 to 1 μ F).

Remarks 1. For pin identification, see 1.4 Pin Identification.

2. Functions in parentheses in the above figure can be assigned via settings in the peripheral I/O redirection register (PIOR).

- 48-pin plastic WHQFN (7 × 7 , 0.5 mm pitch)

(1) USB function: Host/Function controller (R5F10JGC)

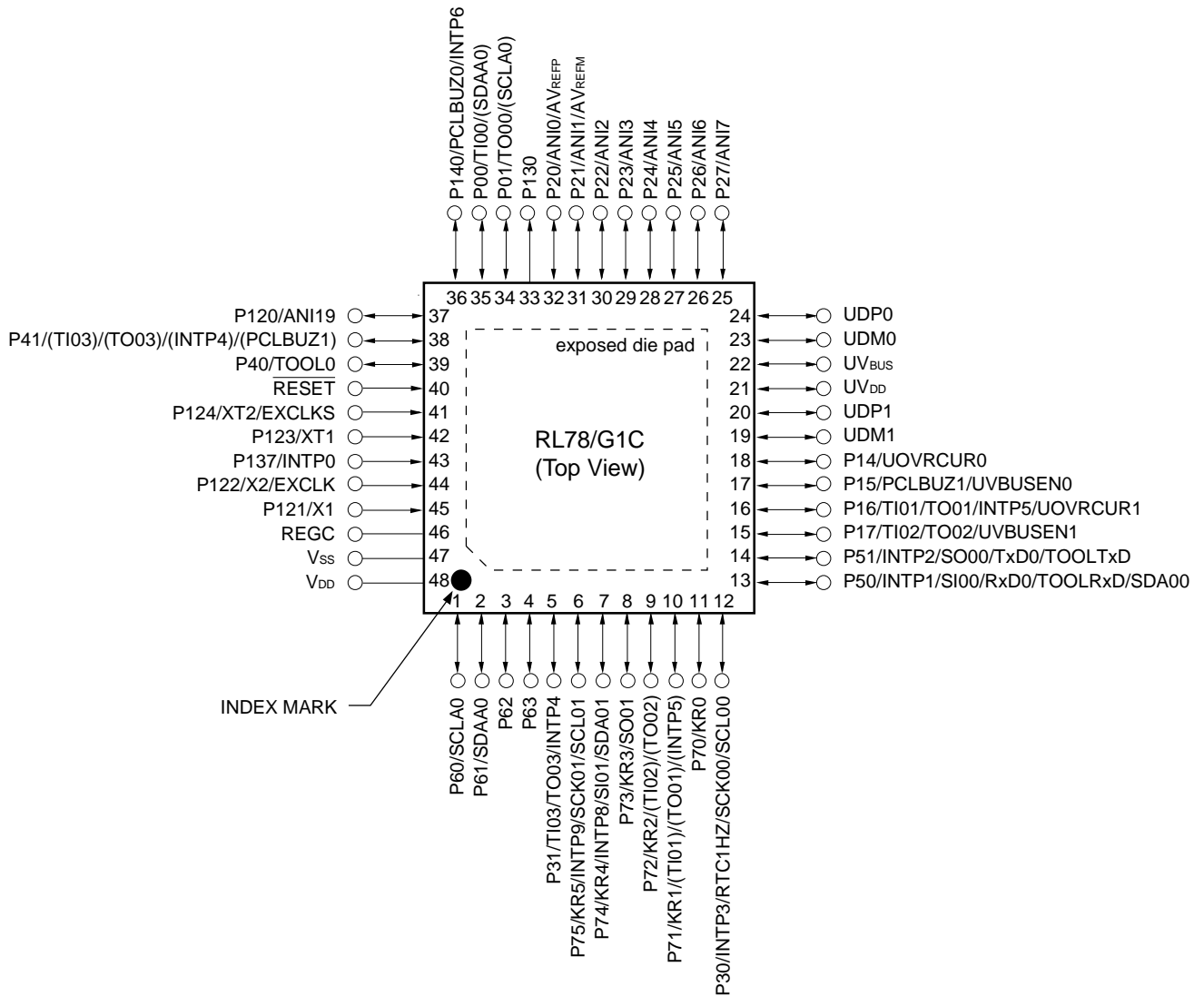

Caution Connect the REGC pin to V_{SS} via a capacitor (0.47 to 1 μF).

Remarks 1. For pin identification, see 1.4 Pin Identification.

2. Functions in parentheses in the above figure can be assigned via settings in the peripheral I/O redirection register (PIOR).
3. It is recommended to connect an exposed die pad to V_{SS}.

(2) USB function: Function controller only (R5F10KGC)

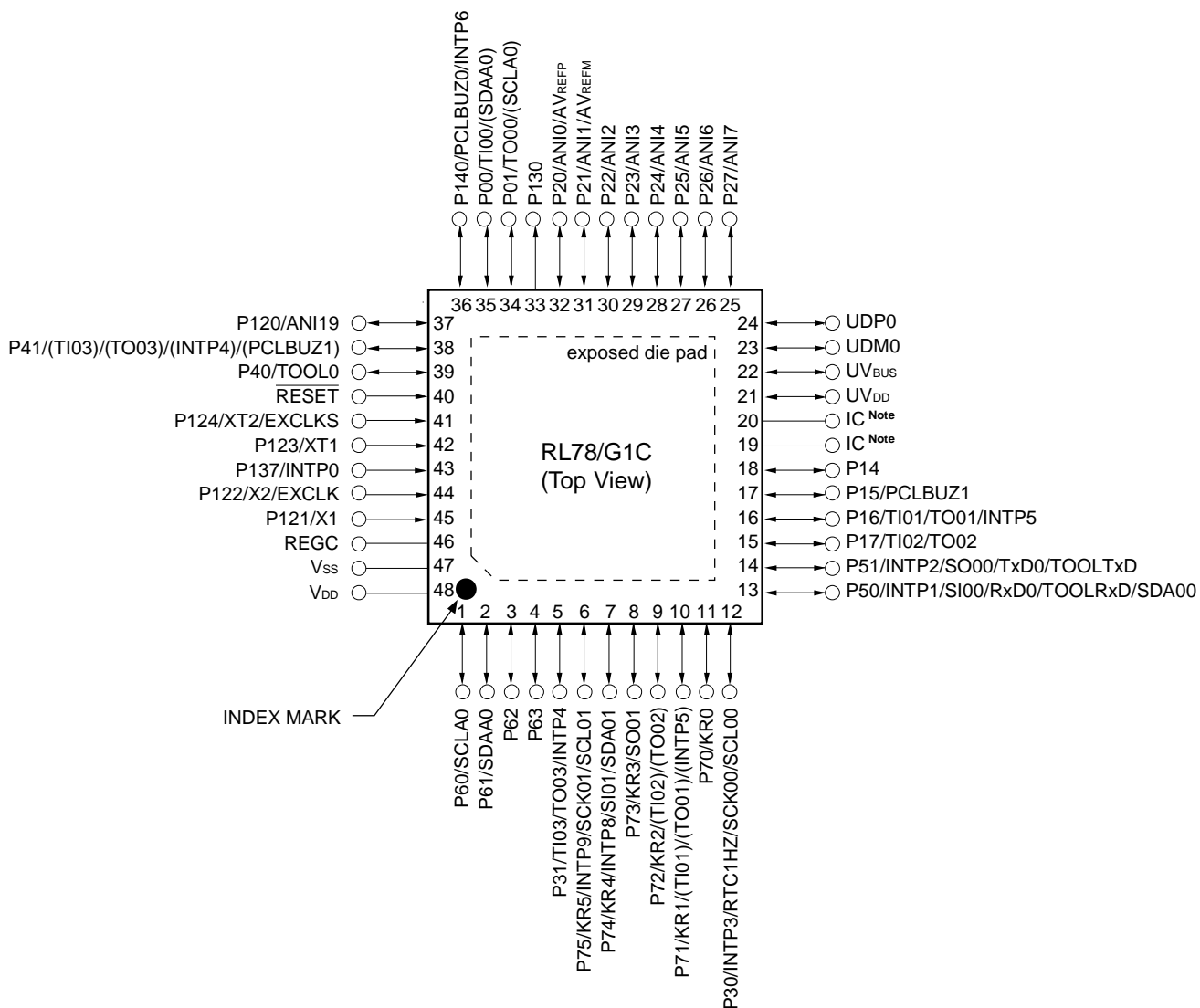

Note IC: Internal Connection Pin Leave open.

Caution Connect the REGC pin to V_{SS} via a capacitor (0.47 to 1 μF).

- Remarks**
- For pin identification, see 1.4 Pin Identification.
 - Functions in parentheses in the above figure can be assigned via settings in the peripheral I/O redirection register (PIOR).
 - It is recommended to connect an exposed die pad to V_{SS}.

1.4 Pin Identification

| | |
|------------------------------------|--|
| ANI0 to ANI7, ANI16, ANI17, ANI19: | Analog Input |
| AVREFM: | Analog Reference Voltage Minus |
| AVREFP: | Analog Reference Voltage Plus |
| EXCLK: | External Clock Input (Main System Clock) |
| EXCLKS: | External Clock Input (Sub System Clock) |
| INTP0 to INTP6, INTP8, INTP9: | External Interrupt Input |
| KR0 to KR5: | Key Return |
| P00, P01: | Port 0 |
| P14 to P17: | Port 1 |
| P20 to P27: | Port 2 |
| P30, P31: | Port 3 |
| P40, P41: | Port 4 |
| P50, P51: | Port 5 |
| P60 to P63: | Port 6 |
| P70 to P75: | Port 7 |
| P120 to P124: | Port 12 |
| P130, P137: | Port 13 |
| P140: | Port 14 |
| PCLBUZ0, PCLBUZ1: | Programmable Clock Output/Buzzer Output |
| REGC: | Regulator Capacitance |
| RESET: | Reset |
| RTC1HZ: | Real-time Clock Correction Clock (1 Hz) Output |
| RxD0: | Receive Data |
| SCK00, SCK01: | Serial Clock Input/Output |
| SCLA0, SCL00, SCL01: | Serial Clock Input/Output |
| SDAA0, SDA00, SDA01: | Serial Data Input/Output |
| SI00, SI01: | Serial Data Input |
| SO00, SO01: | Serial Data Output |
| TI00 to TI03: | Timer Input |
| TO00 to TO03: | Timer Output |
| TOOL0: | Data Input/Output for Tool |
| TOOLRxD, TOOLTxD: | Data Input/Output for External Device |
| TxD0: | Transmit Data |
| UDM0, UDM1, UDP0, UDP1: | USB Input/Output |
| UOVRCUR0, UOVRCUR1: | USB Input |
| UVBUSEN0, UVBUSEN1: | USB Output |
| UVDD: | USB Power Supply/USB Regulator Capacitance |
| UVBUS: | USB Input/USB Power Supply (USB Optional BC) |
| VDD: | Power Supply |
| VSS: | Ground |
| X1, X2: | Crystal Oscillator (Main System Clock) |
| XT1, XT2: | Crystal Oscillator (Subsystem Clock) |

1.5 Block Diagram

1.5.1 32-pin products

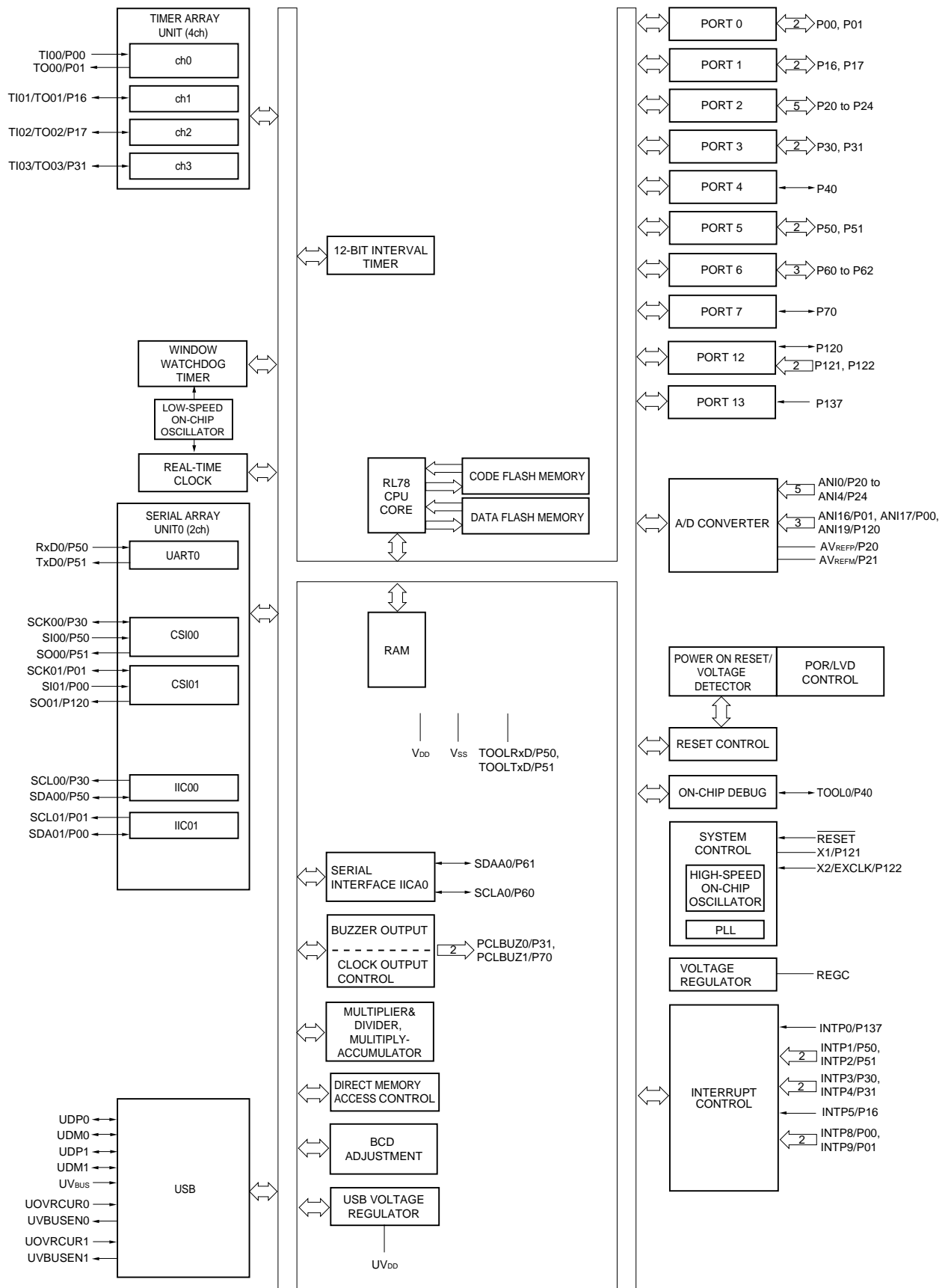

1.5.2 48-pin products

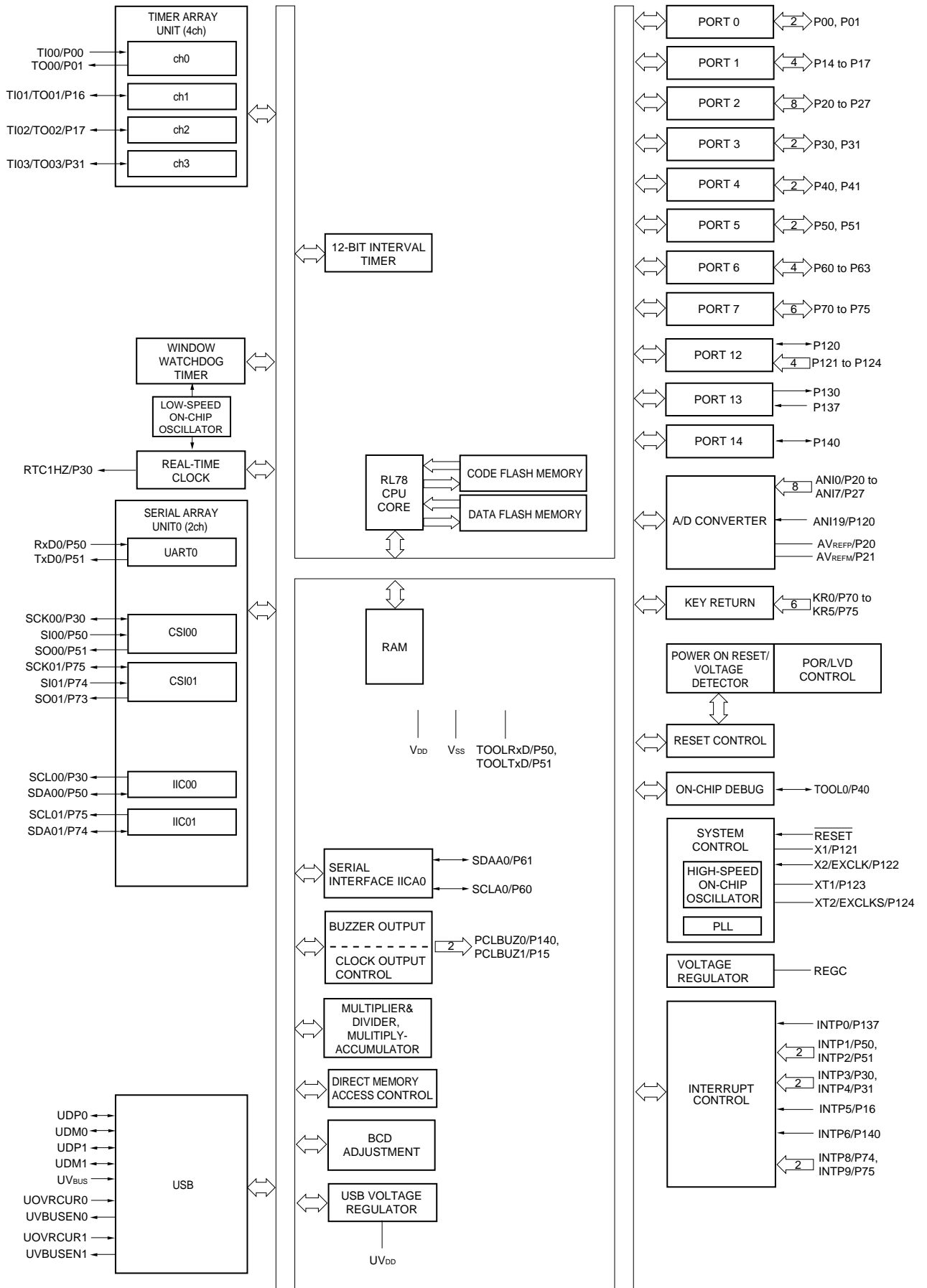

1.6 Outline of Functions

[32-pin, 48-pin products]

(1/2)

| Item | | 32-pin | | 48-pin | |
|------------------------------------|-------------------------------------|---|----------|---|----------|
| | | R5F10JBC | R5F10KBC | R5F10JGC | R5F10KGC |
| Code flash memory (KB) | | 32 KB | | 32 KB | |
| Data flash memory (KB) | | 2 KB | | 2 KB | |
| RAM (KB) | | 5.5 KB ^{Note 1} | | 5.5 KB ^{Note 1} | |
| Memory space | | 1 MB | | | |
| Main system clock | High-speed system clock | X1 (crystal/ceramic) oscillation, external main system clock input (EXCLK) HS (High-speed main) mode: 1 to 20 MHz ($V_{DD} = 2.7$ to 5.5 V), HS (High-speed main) mode: 1 to 16 MHz ($V_{DD} = 2.4$ to 5.5 V) | | | |
| | High-speed on-chip oscillator | 1 to 24 MHz ($V_{DD} = 2.7$ to 5.5 V), 1 to 16 MHz ($V_{DD} = 2.4$ to 5.5 V) | | | |
| | PLL clock | 6, 12, 24 MHz ^{Note 2} : $V_{DD} = 2.4$ to 5.5 V | | | |
| Subsystem clock | | - | | XT1 (crystal) oscillation 32.768 kHz (TYP.): $V_{DD} = 2.4$ to 5.5 V | |
| Low-speed on-chip oscillator | | On-chip oscillation (Watchdog timer/Real-time clock/12-bit interval timer clock) 15 kHz (TYP.): $V_{DD} = 2.4$ to 5.5 V | | | |
| General-purpose register | | 8 bits × 32 registers (8 bits × 8 registers × 4 banks) | | | |
| Minimum instruction execution time | | 0.04167 μ s (High-speed on-chip oscillator: $f_{HOCO} = 48$ MHz / $f_{IH} = 24$ MHz operation) | | | |
| | | 0.04167 μ s (PLL clock: $f_{PLL} = 48$ MHz / $f_{IH} = 24$ MHz ^{Note 2} operation) | | | |
| | | 0.05 μ s (High-speed system clock: $f_{MX} = 20$ MHz operation) | | | |
| | | - | | 30.5 μ s (Subsystem clock: $f_{SUB} = 32.768$ kHz operation) | |
| Instruction set | | <ul style="list-style-type: none"> • Data transfer (8/16 bits) • Adder and subtractor/logical operation (8/16 bits) • Multiplication (8 bits × 8 bits) • Rotate, barrel shift, and bit manipulation (Set, reset, test, and Boolean operation), etc. | | | |
| I/O port | Total | 22 | | 38 | |
| | CMOS I/O | 16 (N-ch O.D. I/O [V_{DD} withstand voltage]: 5) | | 28 (N-ch O.D. I/O [V_{DD} withstand voltage]: 6) | |
| | CMOS input | 3 | | 5 | |
| | CMOS output | - | | 1 | |
| | N-ch open-drain I/O (6 V tolerance) | 3 | | 4 | |
| Timer | 16-bit timer | 4 channel | | | |
| | Watchdog timer | 1 channel | | | |
| | Real-time clock (RTC) | 1 channel ^{Note 3} | | | |
| | 12-bit Interval timer (IT) | 1 channel | | | |
| | Timer output | 4 channels (PWM output: 3) ^{Note 4} | | | |
| | RTC output | - | | 1 • 1 Hz (subsystem clock: $f_{SUB} = 32.768$ kHz) | |

- Notes**
1. In the case of the 5.5 KB, this is about 4.5 KB when the self-programming function is used.
 2. In the PLL clock 48 MHz operation, the system clock is 2/4/8 dividing ratio.
 3. In 32-pin products, this channel can only be used for the constant-period interrupt function based on the low-speed on-chip oscillator clock (f_{IL}).
 4. The number of PWM outputs varies depending on the setting of channels in use (the number of masters and slaves).

Caution This outline describes the functions at the time when Peripheral I/O redirection register (PIOR) is set to 00H.

(2/2)

| Item | 32-pin | | 48-pin | |
|---|--|------------|------------|------------|
| | R5F10JBC | R5F10KBC | R5F10JGC | R5F10KGC |
| Clock output/buzzer output | 2 | | 2 | |
| | <ul style="list-style-type: none"> • 2.93 kHz, 5.86 kHz, 11.7 kHz, 1.5 MHz, 3 MHz, 6 MHz, 12 MHz (Main system clock: $f_{\text{MAIN}} = 24 \text{ MHz}$ operation) • 256 Hz, 512 Hz, 1.024 kHz, 2.048 kHz, 4.096 kHz, 8.192 kHz, 16.384 kHz, 32.768 kHz (Subsystem clock: $f_{\text{SUB}} = 32.768 \text{ kHz}$ operation) | | | |
| 8/10-bit resolution A/D converter | 8 channels | | 9 channels | |
| Serial interface | CSI: 2 channels/UART: 1 channel/simplified I ² C: 2 channels | | | |
| | I ² C bus | 1 channel | | |
| USB | Host controller | 2 channels | – | 2 channels |
| | Function controller | 1 channel | | |
| Multiplier and divider/multiply-accumulator | <ul style="list-style-type: none"> • Multiplier: 16 bits \times 16 bits = 32 bits (Unsigned or signed) • Divider: 32 bits \div 32 bits = 32 bits (Unsigned) • Multiply-accumulator: 16 bits \times 16 bits + 32 bits = 32 bits (Unsigned or signed) | | | |
| DMA controller | 2 channels | | | |
| Vectored interrupt sources | Internal | 20 | | 20 |
| | External | 8 | | 10 |
| Key interrupt | – | | 6 | |
| Reset | <ul style="list-style-type: none"> • Reset by RESET pin • Internal reset by watchdog timer • Internal reset by power-on-reset • Internal reset by voltage detector • Internal reset by illegal instruction execution ^{Note} • Internal reset by RAM parity error • Internal reset by illegal-memory access | | | |
| Power-on-reset circuit | <ul style="list-style-type: none"> • Power-on-reset: 1.51 V (TYP.) • Power-down-reset: 1.50 V (TYP.) | | | |
| Voltage detector | 2.45 V to 4.06 V (9 stages) | | | |
| On-chip debug function | Provided | | | |
| Power supply voltage | $V_{\text{DD}} = 2.4 \text{ to } 5.5 \text{ V}$ | | | |
| Operating ambient temperature | $T_{\text{A}} = -40 \text{ to } +85 \text{ }^{\circ}\text{C}$ (A: Consumer applications), $T_{\text{A}} = -40 \text{ to } +105 \text{ }^{\circ}\text{C}$ (G: Industrial applications) | | | |

Note The illegal instruction is generated when instruction code FFH is executed.

Reset by the illegal instruction execution not issued by emulation with the in-circuit emulator or on-chip debug emulator.

2. ELECTRICAL SPECIFICATIONS (A: T_A = -40 to +85°C)

This chapter describes the electrical specifications for the products "A: Consumer applications (T_A = -40 to +85°C)".

| | |
|---------------------|--|
| The target products | A: Consumer applications ; T _A = -40 to +85°C R5F10JBCANA, R5F10JBCAFP, R5F10JGCANA, R5F10JGCAFB, R5F10KBCANA, R5F10KBCAFP, R5F10KGCANA, R5F10KGCAFB G: Industrial applications ; when using T _A = -40 to +105°C specification products at T _A = -40 to +85°C. R5F10JBCGNA, R5F10JBCGFP, R5F10JGCGNA, R5F10JGCGFB, R5F10KBCGNA, R5F10KBCGFP, R5F10KGCNA, R5F10KGCGB |
|---------------------|--|

Cautions 1. The RL78 microcontrollers has an on-chip debug function, which is provided for development and evaluation. Do not use the on-chip debug function in products designated for mass production, because the guaranteed number of rewritable times of the flash memory may be exceeded when this function is used, and product reliability therefore cannot be guaranteed. Renesas Electronics is not liable for problems occurring when the on-chip debug function is used.

2. The pins mounted depend on the product.

2.1 Absolute Maximum Ratings

Absolute Maximum Ratings (T_A = 25°C) (1/2)

| Parameter | Symbols | Conditions | Ratings | Unit |
|------------------------------------|-------------------------------|--|--|------|
| Supply voltage | V _{DD} | | -0.5 to +6.5 | V |
| REGC pin input voltage | V _{I_{REGC}} | REGC | -0.3 to +2.8 and -0.3 to V _{DD} +0.3 ^{Note 1} | V |
| UV _{DD} pin input voltage | V _{I_{UVDD}} | UV _{DD} | -0.3 to V _{DD} +0.3 | V |
| Input voltage | V _{I1} | P00, P01, P14 to P17, P20 to P27, P30, P31, P40, P41, P50, P51, P70 to P75, P120 to P124, P137, P140, EXCLK, EXCLKS, RESET | -0.3 to V _{DD} +0.3 ^{Note 2} | V |
| | V _{I2} | P60 to P63 (N-ch open-drain) | -0.3 to +6.5 | V |
| | V _{I3} | UDP0, UDM0, UDP1, UDM1 | -0.3 to +6.5 | V |
| | V _{I4} | UV _{BUS} | -0.3 to +6.5 | V |
| Output voltage | V _{O1} | P00, P01, P14 to P17, P20 to P27, P30, P31, P40, P41, P50, P51, P60 to P63, P70 to P75, P120, P130, P140 | -0.3 to V _{DD} +0.3 ^{Note 2} | V |
| | V _{O2} | UDP0, UDM0, UDP1, UDM1 | -0.3 to +6.5 | V |
| Analog input voltage | V _{AI1} | ANI16, ANI17, ANI19 | -0.3 to V _{DD} +0.3 and -0.3 to AV _{REF} (+) +0.3 Notes 2, 3 | V |
| | V _{AI2} | ANI0 to ANI7 | -0.3 to V _{DD} +0.3 and -0.3 to AV _{REF} (+) +0.3 Notes 2, 3 | V |

- Notes 1.** Connect the REGC pin to V_{SS} via a capacitor (0.47 to 1 μF). This value regulates the absolute maximum rating of the REGC pin. Do not use this pin with voltage applied to it.
2. Must be 6.5 V or lower.
 3. Do not exceed AV_{REF}(+) + 0.3 V in case of A/D conversion target pin

Caution Product quality may suffer if the absolute maximum rating is exceeded even momentarily for any parameter. That is, the absolute maximum ratings are rated values at which the product is on the verge of suffering physical damage, and therefore the product must be used under conditions that ensure that the absolute maximum ratings are not exceeded.

- Remarks 1.** Unless specified otherwise, the characteristics of alternate-function pins are the same as those of the port pins.
2. AV_{REF} (+) : The + side reference voltage of the A/D converter. This can be selected from AV_{REFP}, the internal reference voltage (1.45 V), and V_{DD}.
 3. V_{SS} : Reference voltage

Absolute Maximum Ratings (T_A = 25°C) (2/2)

| Parameter | Symbols | Conditions | | Ratings | Unit |
|-------------------------------|----------------------------------|------------------------------|--|--|------------|
| Output current, high | I _{OH1} | Per pin | P00, P01, P14 to P17, P30, P31, P40, P41, P50, P51, P70 to P75, P120, P130, P140 | -40 | |
| | | Total of all pins -170 mA | P00, P01, P40, P41, P120, P130, P140 | -70 | mA |
| | | | P14 to P17, P30, P31, P50, P51, P70 to P75 | -100 | mA |
| | I _{OH2} | Per pin | P20 to P27 | -0.5 | mA |
| | | Total of all pins | | -2 | mA |
| | Output current, low | I _{OL1} | Per pin | P00, P01, P14 to P17, P30, P31, P40, P41, P50, P51, P60 to P63, P70 to P75, P120, P130, P140 | 40 |
| Total of all pins 170 mA | | | P00, P01, P40, P41, P120, P130, P140 | 70 | mA |
| | | | P14 to P17, P30, P31, P50, P51, P60 to P63, P70 to P75 | 100 | mA |
| I _{OL2} | | Per pin | P20 to P27 | 1 | mA |
| | | Total of all pins | | 5 | mA |
| Operating ambient temperature | | T _A | In normal operation mode | | -40 to +85 |
| | In flash memory programming mode | | | | |
| Storage temperature | T _{stg} | | | -65 to +150 | °C |

Caution Product quality may suffer if the absolute maximum rating is exceeded even momentarily for any parameter. That is, the absolute maximum ratings are rated values at which the product is on the verge of suffering physical damage, and therefore the product must be used under conditions that ensure that the absolute maximum ratings are not exceeded.

Remark Unless specified otherwise, the characteristics of alternate-function pins are the same as those of the port pins.

2.2 Oscillator Characteristics

2.2.1 X1, XT1 oscillator characteristics

(T_A = -40 to +85°C, 2.4 V ≤ V_{DD} ≤ 5.5 V, V_{SS} = 0 V)

| Parameter | Resonator | Conditions | MIN. | TYP. | MAX. | Unit |
|--|---|---------------------------------|------|--------|------|------|
| X1 clock oscillation frequency (f _X) ^{Note} | Ceramic resonator/ crystal resonator | 2.7 V ≤ V _{DD} ≤ 5.5 V | 1.0 | | 20.0 | MHz |
| | | 2.4 V ≤ V _{DD} < 2.7 V | 1.0 | | 16.0 | MHz |
| XT1 clock oscillation frequency (f _{XT}) ^{Note} | Crystal resonator | | 32 | 32.768 | 35 | kHz |

Note Indicates only permissible oscillator frequency ranges. Refer to AC Characteristics for instruction execution time. Request evaluation by the manufacturer of the oscillator circuit mounted on a board to check the oscillator characteristics.

Caution Since the CPU is started by the high-speed on-chip oscillator clock after a reset release, check the X1 clock oscillation stabilization time using the oscillation stabilization time counter status register (OSTC) by the user. Determine the oscillation stabilization time of the OSTC register and the oscillation stabilization time select register (OSTS) after sufficiently evaluating the oscillation stabilization time with the resonator to be used.

2.2.2 On-chip oscillator characteristics

(T_A = -40 to +85°C, 2.4 V ≤ V_{DD} ≤ 5.5 V, V_{SS} = 0 V)

| Oscillators | Parameters | Conditions | MIN. | TYP. | MAX. | Unit |
|---|-------------------|---------------|------|------|------|------|
| High-speed on-chip oscillator clock frequency ^{Notes 1, 2} | f _{HOCO} | | 1 | | 48 | MHz |
| High-speed on-chip oscillator clock frequency accuracy | | -20 to +85 °C | -1.0 | | +1.0 | % |
| | | -40 to -20 °C | -1.5 | | +1.5 | % |
| Low-speed on-chip oscillator clock frequency | f _{IL} | | | 15 | | kHz |
| Low-speed on-chip oscillator clock frequency accuracy | | | -15 | | +15 | % |

Notes 1. High-speed on-chip oscillator frequency is selected by bits 0 to 3 of option byte (000C2H/010C2H) and bits 0 to 2 of HOCODIV register.

2. This indicates the oscillator characteristics only. Refer to AC Characteristics for instruction execution time.

2.2.3 PLL oscillator characteristics

(T_A = -40 to +85°C, 2.4 V ≤ V_{DD} ≤ 5.5 V, V_{SS} = 0 V)

| Oscillators | Parameters | Conditions | MIN. | TYP. | MAX. | Unit |
|--------------------------------------|--------------------|--|-------|-------|-------|------|
| PLL input frequency ^{Note} | f _{PLLIN} | High-speed system clock | 6.00 | | 16.00 | MHz |
| PLL output frequency ^{Note} | f _{PLL} | | | 48.00 | | MHz |
| Lock up time | | From PLL output enable to stabilization of the output frequency | 40.00 | | | μs |
| Interval time | | From PLL stop to PLL re-operation setting Wait time | 4.00 | | | μs |
| Setting wait time | | From after PLL input clock stabilization and PLL setting is fixed to start setting Wait time required | 1.00 | | | μs |

Note Indicates only oscillator characteristics. Refer to AC Characteristics for instruction execution time.

2.3 DC Characteristics

2.3.1 Pin characteristics

(T_A = -40 to +85°C, 2.4 V ≤ V_{DD} ≤ 5.5 V, V_{SS} = 0 V)

| Items | Symbol | Conditions | MIN. | TYP. | MAX. | Unit | |
|--|---|--|---------------------------------|------|--------|------------------------|----|
| Output current, high ^{Note 1} | I _{OH1} | Per pin for P00, P01, P14 to P17, P30, P31, P40, P41, P50, P51, P70 to P75, P120, P130, P140 | 2.4 V ≤ V _{DD} ≤ 5.5 V | | | -10.0 Note 2 | mA |
| | | Total of P00, P01, P40, P41, P120, P130, P140 (When duty ≤ 70% ^{Note 3}) | 4.0 V ≤ V _{DD} ≤ 5.5 V | | | -55.0 | mA |
| | | | 2.7 V ≤ V _{DD} < 4.0 V | | | -10.0 | mA |
| | | | 2.4 V ≤ V _{DD} < 2.7 V | | | -5.0 | mA |
| | | Total of P14 to P17, P30, P31, P50, P51, P70 to P75 (When duty ≤ 70% ^{Note 3}) | 4.0 V ≤ V _{DD} ≤ 5.5 V | | | -80.0 | mA |
| | | | 2.7 V ≤ V _{DD} < 4.0 V | | | -19.0 | mA |
| | | | 2.4 V ≤ V _{DD} < 2.7 V | | | -10.0 | mA |
| | Total of all pins (When duty ≤ 70% ^{Note 3}) | 2.4 V ≤ V _{DD} ≤ 5.5 V | | | -135.0 | mA | |
| | I _{OH2} | Per pin for P20 to P27 | 2.4 V ≤ V _{DD} ≤ 5.5 V | | | -0.1 ^{Note 2} | mA |
| | | Total of all pins (When duty ≤ 70% ^{Note 3}) | 2.4 V ≤ V _{DD} ≤ 5.5 V | | | -1.5 | mA |

- Notes**
- Value of current at which the device operation is guaranteed even if the current flows from the V_{DD} pin to an output pin.
 - However, do not exceed the total current value.
 - Specification under conditions where the duty factor ≤ 70%.

The output current value that has changed to the duty factor > 70% the duty ratio can be calculated with the following expression (when changing the duty ratio to n%).

- Total output current of pins = (I_{OH} × 0.7)/(n × 0.01)

<Example> Where n = 80% and I_{OH} = -10.0 mA

$$\text{Total output current of pins} = (-10.0 \times 0.7)/(80 \times 0.01) \cong -8.7 \text{ mA}$$

However, the current that is allowed to flow into one pin does not vary depending on the duty factor. A current higher than the absolute maximum rating must not flow into one pin.

Caution P00, P01, P30, and P74 do not output high level in N-ch open-drain mode.

Remark Unless specified otherwise, the characteristics of alternate-function pins are the same as those of the port pins.

(T_A = -40 to +85°C, 2.4 V ≤ V_{DD} ≤ 5.5 V, V_{SS} = 0 V)

| Items | Symbol | Conditions | MIN. | TYP. | MAX. | Unit | |
|---|---|---|---------------------------------|------|-------|------------------------|----|
| Output current, I _{OL} ^{Note 1} | I _{OL1} | Per pin for P00, P01, P14 to P17, P30, P31, P40, P41, P50, P51, P70 to P75, P120, P130, P140 | 2.4V ≤ V _{DD} ≤ 5.5 V | | | 20.0 ^{Note 2} | mA |
| | | Per pin for P60 to P63 | 2.4V ≤ V _{DD} ≤ 5.5 V | | | 20.0 ^{Note 2} | mA |
| | | Total of P00, P01, P40, P41, P120, P130, P140 (When duty ≤ 70% ^{Note 3}) | 4.0 V ≤ V _{DD} ≤ 5.5 V | | | 70.0 | mA |
| | | | 2.7 V ≤ V _{DD} < 4.0 V | | | 15.0 | mA |
| | | | 2.4 V ≤ V _{DD} < 2.7 V | | | 9.0 | mA |
| | | Total of P14 to P17, P30, P31, P50, P51, P60 to P63, P70 to P75 (When duty ≤ 70% ^{Note 3}) | 4.0 V ≤ V _{DD} ≤ 5.5 V | | | 80.0 | mA |
| | | | 2.7 V ≤ V _{DD} < 4.0 V | | | 35.0 | mA |
| | 2.4 V ≤ V _{DD} < 2.7 V | | | | 20.0 | mA | |
| | Total of all pins (When duty ≤ 70% ^{Note 3}) | 2.4V ≤ V _{DD} ≤ 5.5 V | | | 150.0 | mA | |
| | I _{OL2} | Per pin for P20 to P27 | 2.4V ≤ V _{DD} ≤ 5.5 V | | | 0.4 ^{Note 2} | mA |
| Total of all pins (When duty ≤ 70% ^{Note 3}) | | 2.4V ≤ V _{DD} ≤ 5.5 V | | | 5.0 | mA | |

Notes 1. Value of current at which the device operation is guaranteed even if the current flows from an output pin to the V_{SS} pin.

2. However, do not exceed the total current value.

3. Specification under conditions where the duty factor ≤ 70%.

The output current value that has changed to the duty factor > 70% the duty ratio can be calculated with the following expression (when changing the duty ratio to n%).

- Total output current of pins = (I_{OL} × 0.7)/(n × 0.01)

<Example> Where n = 80% and I_{OL} = 10.0 mA

$$\text{Total output current of pins} = (10.0 \times 0.7)/(80 \times 0.01) \cong 8.7 \text{ mA}$$

However, the current that is allowed to flow into one pin does not vary depending on the duty factor.

A current higher than the absolute maximum rating must not flow into one pin.

Remark Unless specified otherwise, the characteristics of alternate-function pins are the same as those of the port pins.

($T_A = -40$ to $+85^\circ\text{C}$, $2.4\text{ V} \leq V_{DD} \leq 5.5\text{ V}$, $V_{SS} = 0\text{ V}$)

| Items | Symbol | Conditions | MIN. | TYP. | MAX. | Unit | |
|------------------------|-----------|--|--|-------------|------|-------------|---|
| Input voltage, high | V_{IH1} | P00, P01, P14 to P17, P30, P31, P40, P41, P50, P51, P70 to P75, P120, P140 | Normal input buffer | $0.8V_{DD}$ | | V_{DD} | V |
| | V_{IH2} | P00, P01, P30, P50 | TTL input buffer $4.0\text{ V} \leq V_{DD} \leq 5.5\text{ V}$ | 2.2 | | V_{DD} | V |
| | | | TTL input buffer $3.3\text{ V} \leq V_{DD} < 4.0\text{ V}$ | 2.0 | | V_{DD} | V |
| | | | TTL input buffer $2.4\text{ V} \leq V_{DD} < 3.3\text{ V}$ | 1.5 | | V_{DD} | V |
| | V_{IH3} | P20 to P27 | | $0.7V_{DD}$ | | V_{DD} | V |
| | V_{IH4} | P60 to P63 | | $0.7V_{DD}$ | | 6.0 | V |
| | V_{IH5} | P121 to P124, P137, EXCLK, EXCLKS, $\overline{\text{RESET}}$ | | $0.8V_{DD}$ | | V_{DD} | V |
| Input voltage, low | V_{IL1} | P00, P01, P14 to P17, P30, P31, P40, P41, P50, P51, P70 to P75, P120, P140 | Normal input buffer | 0 | | $0.2V_{DD}$ | V |
| | V_{IL2} | P00, P01, P30, P50 | TTL input buffer $4.0\text{ V} \leq V_{DD} \leq 5.5\text{ V}$ | 0 | | 0.8 | V |
| | | | TTL input buffer $3.3\text{ V} \leq V_{DD} < 4.0\text{ V}$ | 0 | | 0.5 | V |
| | | | TTL input buffer $2.4\text{ V} \leq V_{DD} < 3.3\text{ V}$ | 0 | | 0.32 | V |
| | V_{IL3} | P20 to P27 | | 0 | | $0.3V_{DD}$ | V |
| | V_{IL4} | P60 to P63 | | 0 | | $0.3V_{DD}$ | V |
| | V_{IL5} | P121 to P124, P137, EXCLK, EXCLKS, $\overline{\text{RESET}}$ | | 0 | | $0.2V_{DD}$ | V |

Caution The maximum value of V_{IH} of pins P00, P01, P30, and P74 is V_{DD} , even in the N-ch open-drain mode.

Remark Unless specified otherwise, the characteristics of alternate-function pins are the same as those of the port pins.

($T_A = -40$ to $+85^\circ\text{C}$, $2.4\text{ V} \leq V_{DD} \leq 5.5\text{ V}$, $V_{SS} = 0\text{ V}$)

| Items | Symbol | Conditions | MIN. | TYP. | MAX. | Unit | |
|----------------------|------------------|--|--|-----------------------|------|------|---|
| Output voltage, high | V _{OH1} | P00, P01, P14 to P17, P30, P31, P40, P41, P50, P51, P70 to P75, P120, P130, P140 | 4.0 V \leq V _{DD} \leq 5.5 V, I _{OH1} = -10.0 mA | V _{DD} - 1.5 | | | V |
| | | | 4.0 V \leq V _{DD} \leq 5.5 V, I _{OH1} = -3.0 mA | V _{DD} - 0.7 | | | V |
| | | | 2.7 V \leq V _{DD} \leq 5.5 V, I _{OH1} = -2.0 mA | V _{DD} - 0.6 | | | V |
| | | | 2.4 V \leq V _{DD} \leq 5.5 V, I _{OH1} = -1.5 mA | V _{DD} - 0.5 | | | V |
| | V _{OH2} | P20 to P27 | 2.4 V \leq V _{DD} \leq 5.5 V, I _{OH2} = -100 μ A | V _{DD} - 0.5 | | | V |
| Output voltage, low | V _{OL1} | P00, P01, P14 to P17, P30, P31, P40, P41, P50, P51, P70 to P75, P120, P130, P140 | 4.0 V \leq V _{DD} \leq 5.5 V, I _{OL1} = 20.0 mA | | | 1.3 | V |
| | | | 4.0 V \leq V _{DD} \leq 5.5 V, I _{OL1} = 8.5 mA | | | 0.7 | V |
| | | | 2.7 V \leq V _{DD} \leq 5.5 V, I _{OL1} = 3.0 mA | | | 0.6 | V |
| | | | 2.7 V \leq V _{DD} \leq 5.5 V, I _{OL1} = 1.5 mA | | | 0.4 | V |
| | | | 2.4 V \leq V _{DD} \leq 5.5 V, I _{OL1} = 0.6 mA | | | 0.4 | V |
| | V _{OL2} | P20 to P27 | 2.4 V \leq V _{DD} \leq 5.5 V, I _{OL2} = 400 μ A | | | 0.4 | V |
| | V _{OL3} | P60 to P63 | 4.0 V \leq V _{DD} \leq 5.5 V, I _{OL1} = 20.0 mA | | | 2.0 | V |
| | | | 4.0 V \leq V _{DD} \leq 5.5 V, I _{OL1} = 5.0 mA | | | 0.4 | V |
| | | | 2.7 V \leq V _{DD} \leq 5.5 V, I _{OL1} = 3.0 mA | | | 0.4 | V |
| | | | 2.4 V \leq V _{DD} \leq 5.5 V, I _{OL1} = 2.0 mA | | | 0.4 | V |

Caution P00, P01, P30, and P74 do not output high level in N-ch open-drain mode.

Remark Unless specified otherwise, the characteristics of alternate-function pins are the same as those of the port pins.

($T_A = -40$ to $+85^\circ\text{C}$, $2.4\text{ V} \leq V_{DD} \leq 5.5\text{ V}$, $V_{SS} = 0\text{ V}$)

| Items | Symbol | Conditions | MIN. | TYP. | MAX. | Unit | | |
|-----------------------------|-------------------|---|--------------------------------|---------------------------------------|------|------|------------------|---------------|
| Input leakage current, high | I _{LIH1} | P00, P01, P14 to P17, P20 to P27, P30, P31, P40, P41, P50, P51, P60 to P63, P70 to P75, P120, P137, P140, $\overline{\text{RESET}}$ | $V_i = V_{DD}$ | | | 1 | μA | |
| | I _{LIH2} | P121 to P124 (X1, X2, XT1, XT2, EXCLK, EXCLKS) | $V_i = V_{DD}$ | In input port or external clock input | | | 1 | μA |
| | | | | In resonator connection | | | 10 | μA |
| Input leakage current, low | I _{LIL1} | P00, P01, P14 to P17, P20 to P27, P30, P31, P40, P41, P50, P51, P60 to P63, P70 to P75, P120, P137, P140, $\overline{\text{RESET}}$ | $V_i = V_{SS}$ | | | -1 | μA | |
| | I _{LIL2} | P121 to P124 (X1, X2, XT1, XT2, EXCLK, EXCLKS) | $V_i = V_{SS}$ | In input port or external clock input | | | -1 | μA |
| | | | | In resonator connection | | | -10 | μA |
| On-chip pll-up resistance | R _U | P00, P01, P14 to P17, P30, P31, P40, P41, P50, P51, P70 to P75, P120, P140 | $V_i = V_{SS}$, In input port | 10 | 20 | 100 | $\text{k}\Omega$ | |

Remark Unless specified otherwise, the characteristics of alternate-function pins are the same as those of the port pins.

2.3.2 Supply current characteristics

(T_A = -40 to +85°C, 2.4 V ≤ V_{DD} ≤ 5.5 V, V_{SS} = 0 V)

(1/2)

| Parameter | Symbol | Conditions | | | | MIN. | TYP. | MAX. | Unit | |
|---------------------------|---|---|---|---|-------------------------|-------------------------|------|------|------|----|
| Supply current Note 1 | I _{DD1} | Operating mode | HS (High-speed main) mode Note 6 | f _{HOCO} = 48 MHz f _{IH} = 24 MHz Note 3 | Basic operation | V _{DD} = 5.0 V | | 1.7 | | mA |
| | | | | | | V _{DD} = 3.0 V | | 1.7 | | mA |
| | | | | Normal operation | V _{DD} = 5.0 V | | 3.7 | 5.5 | mA | |
| | | | | | V _{DD} = 3.0 V | | 3.7 | 5.5 | mA | |
| | | | | Normal operation | V _{DD} = 5.0 V | | 2.3 | 3.2 | mA | |
| | | | | | V _{DD} = 3.0 V | | 2.3 | 3.2 | mA | |
| | | | Normal operation | V _{DD} = 5.0 V | | 1.6 | 2.0 | mA | | |
| | | | | V _{DD} = 3.0 V | | 1.6 | 2.0 | mA | | |
| | | | Normal operation | V _{DD} = 5.0 V | | 1.2 | 1.5 | mA | | |
| | | | | V _{DD} = 3.0 V | | 1.2 | 1.5 | mA | | |
| | | | HS (High-speed main) mode Note 6 | f _{MX} = 20 MHz ^{Note 2} , V _{DD} = 5.0 V | Normal operation | Square wave input | | 3.0 | 4.6 | mA |
| | | | | | | Resonator connection | | 3.2 | 4.8 | mA |
| | | Normal operation | | Square wave input | | 3.0 | 4.6 | mA | | |
| | | | | Resonator connection | | 3.2 | 4.8 | mA | | |
| | | Normal operation | | Square wave input | | 1.9 | 2.7 | mA | | |
| | | | | Resonator connection | | 1.9 | 2.7 | mA | | |
| | | Normal operation | | Square wave input | | 1.9 | 2.7 | mA | | |
| | | | | Resonator connection | | 1.9 | 2.7 | mA | | |
| | | HS (High-speed main) mode (PLL operation) Note 6 | f _{PLL} = 48 MHz, f _{CLK} = 24 MHz ^{Note 2} | Normal operation | V _{DD} = 5.0 V | | 4.0 | 5.9 | mA | |
| | | | | | V _{DD} = 3.0 V | | 4.0 | 5.9 | mA | |
| | | | Normal operation | V _{DD} = 5.0 V | | 2.6 | 3.6 | mA | | |
| | | | | V _{DD} = 3.0 V | | 2.6 | 3.6 | mA | | |
| | | | Normal operation | V _{DD} = 5.0 V | | 1.9 | 2.4 | mA | | |
| | | | | V _{DD} = 3.0 V | | 1.9 | 2.4 | mA | | |
| Subsystem clock operation | f _{SUB} = 32.768 kHz Note 4 T _A = -40°C | Normal operation | Resonator connection | | 4.1 | 4.9 | μA | | | |
| | | | Square wave input | | 4.2 | 5.0 | μA | | | |
| | Normal operation | Square wave input | | 4.1 | 4.9 | μA | | | | |
| | | Resonator connection | | 4.2 | 5.0 | μA | | | | |
| | Normal operation | Square wave input | | 4.2 | 5.5 | μA | | | | |
| | | Resonator connection | | 4.3 | 5.6 | μA | | | | |
| | Normal operation | Square wave input | | 4.2 | 6.3 | μA | | | | |
| | | Resonator connection | | 4.3 | 6.4 | μA | | | | |
| | Normal operation | Square wave input | | 4.8 | 7.7 | μA | | | | |
| | | Resonator connection | | 4.9 | 7.8 | μA | | | | |

(Notes and Remarks are listed on the next page.)

- Notes**
1. Total current flowing into V_{DD}, including the input leakage current flowing when the level of the input pin is fixed to V_{DD}, or V_{SS}. The values below the MAX. column include the peripheral operation current. However, not including the current flowing into the A/D converter, LVD circuit, I/O port, and on-chip pull-up/pull-down resistors and the current flowing during data flash rewrite.
 2. When high-speed on-chip oscillator and subsystem clock are stopped.
 3. When high-speed system clock and subsystem clock are stopped.
 4. When high-speed on-chip oscillator and high-speed system clock are stopped. When AMPHS1 = 1 (Ultra-low power consumption oscillation). However, not including the current flowing into the RTC, 12-bit interval timer, and watchdog timer.
 5. When Operating frequency setting of option byte = 48 MHz. When f_{HOCO} is divided by HOCODIV. When RDIV[1:0] = 00 (divided by 2: default).
 6. Relationship between operation voltage width, operation frequency of CPU and operation mode is as below.

| | |
|----------------------------|---|
| HS (high-speed main) mode: | 2.7 V ≤ V _{DD} ≤ 5.5 V@1 MHz to 24 MHz |
| | 2.4 V ≤ V _{DD} ≤ 5.5 V@1 MHz to 16 MHz |

- Remarks**
1. f_{HOCO}: High-speed on-chip oscillator clock frequency (Max. 48 MHz)
 2. f_{IH}: Main system clock source frequency obtained by dividing the high-speed on-chip oscillator clock by 2, 4, or 8 (Max. 24 MHz)
 3. f_{IMX}: High-speed system clock frequency (X1 clock oscillation frequency or external main system clock frequency)
 4. f_{PLL}: PLL oscillation frequency
 5. f_{SUB}: Subsystem clock frequency (XT1 clock oscillation frequency)
 6. f_{CLK}: CPU/peripheral hardware clock frequency
 7. Except subsystem clock operation, temperature condition of the TYP. value is T_A = 25°C.

(T_A = -40 to +85°C, 2.4 V ≤ V_{DD} ≤ 5.5 V, V_{SS} = 0 V)

(2/2)

| Parameter | Symbol | Conditions | | MIN. | TYP. | MAX. | Unit | | |
|--------------------------|--------------------------------------|------------------------|---|---|--|-------------------------|------|------|----|
| Supply current Note 1 | I _{DD2} Note 2 | HALT mode | HS (High-speed main) mode Note 9 | f _{HOCO} = 48 MHz | V _{DD} = 5.0 V | 0.67 | 1.25 | mA | |
| | | | | f _{IH} = 24 MHz Note 4 | V _{DD} = 3.0 V | 0.67 | 1.25 | mA | |
| | | | | f _{HOCO} = 24 MHz Note 7 | V _{DD} = 5.0 V | 0.50 | 0.86 | mA | |
| | | | | f _{IH} = 12 MHz Note 4 | V _{DD} = 3.0 V | 0.50 | 0.86 | mA | |
| | | | | f _{HOCO} = 12 MHz Note 7 | V _{DD} = 5.0 V | 0.41 | 0.67 | mA | |
| | | | | f _{IH} = 6 MHz Note 4 | V _{DD} = 3.0 V | 0.41 | 0.67 | mA | |
| | | | | f _{HOCO} = 6 MHz Note 7 | V _{DD} = 5.0 V | 0.37 | 0.58 | mA | |
| | | | | f _{IH} = 3 MHz Note 4 | V _{DD} = 3.0 V | 0.37 | 0.58 | mA | |
| | | | | HS (High-speed main) mode Note 9 | f _{MX} = 20 MHz Note 3, V _{DD} = 5.0 V | Square wave input | 0.28 | 1.00 | mA |
| | | | | | Resonator connection | 0.45 | 1.17 | mA | |
| | | | f _{MX} = 20 MHz Note 3, V _{DD} = 3.0 V | | | Square wave input | 0.28 | 1.00 | mA |
| | | | Resonator connection | | 0.45 | 1.17 | mA | | |
| | | | | | f _{MX} = 10 MHz Note 3, V _{DD} = 5.0 V | Square wave input | 0.19 | 0.60 | mA |
| | | | Resonator connection | | 0.26 | 0.67 | mA | | |
| | | | | | f _{MX} = 10 MHz Note 3, V _{DD} = 3.0 V | Square wave input | 0.19 | 0.60 | mA |
| | | | Resonator connection | | 0.26 | 0.67 | mA | | |
| | | | | HS (High-speed main) mode (PLL operation) Note 9 | f _{PLL} = 48 MHz, f _{CLK} = 24 MHz Note 3 | V _{DD} = 5.0 V | 0.91 | 1.52 | mA |
| | | | V _{DD} = 3.0 V | | 0.91 | 1.52 | mA | | |
| | | | | | f _{PLL} = 48 MHz, f _{CLK} = 12 MHz Note 3 | V _{DD} = 5.0 V | 0.85 | 1.28 | mA |
| | | | V _{DD} = 3.0 V | | 0.85 | 1.28 | mA | | |
| | | | | Subsystem clock operation | f _{SUB} = 32.768 kHz Note 5 | Square wave input | 0.25 | 0.57 | μA |
| | | | T _A = -40°C | | Resonator connection | 0.44 | 0.76 | μA | |
| | | | | | f _{SUB} = 32.768 kHz Note 5 | Square wave input | 0.30 | 0.57 | μA |
| | | | T _A = +25°C | | Resonator connection | 0.49 | 0.76 | μA | |
| | | | | | f _{SUB} = 32.768 kHz Note 5 | Square wave input | 0.33 | 1.17 | μA |
| | | | T _A = +50°C | | Resonator connection | 0.63 | 1.36 | μA | |
| | | | | | f _{SUB} = 32.768 kHz Note 5 | Square wave input | 0.46 | 1.97 | μA |
| T _A = +70°C | Resonator connection | 0.76 | 2.16 | | μA | | | | |
| | f _{SUB} = 32.768 kHz Note 5 | Square wave input | 0.97 | 3.37 | μA | | | | |
| T _A = +85°C | Resonator connection | 1.16 | 3.56 | μA | | | | | |
| | STOP mode Note 8 | T _A = -40°C | 0.18 | 0.50 | μA | | | | |
| T _A = +25°C | | 0.23 | 0.50 | μA | | | | | |
| T _A = +50°C | | 0.26 | 1.10 | μA | | | | | |
| T _A = +70°C | | 0.29 | 1.90 | μA | | | | | |
| T _A = +85°C | | 0.90 | 3.30 | μA | | | | | |

(Notes and Remarks are listed on the next page.)

- Notes**
1. Total current flowing into V_{DD} , including the input leakage current flowing when the level of the input pin is fixed to V_{DD} or V_{SS} . The values below the MAX. column include the peripheral operation current. However, not including the current flowing into the A/D converter, LVD circuit, USB 2.0 host/function module, I/O port, and on-chip pull-up/pull-down resistors and the current flowing during data flash rewrite.
 2. During HALT instruction execution by flash memory.
 3. When high-speed on-chip oscillator and subsystem clock are stopped.
 4. When high-speed system clock and subsystem clock are stopped.
 5. When high-speed on-chip oscillator and high-speed system clock are stopped. When $RTCLPC = 1$ and setting ultra-low current consumption ($AMPHS1 = 1$). The current flowing into the RTC is included. However, not including the current flowing into the 12-bit interval timer and watchdog timer.
 6. Not including the current flowing into the RTC, 12-bit interval timer, and watchdog timer.
 7. When Operating frequency setting of option byte = 48 MHz. When f_{HOCO} is divided by HOCODIV. When $RDIV[1:0] = 00$ (divided by 2: default).
 8. Regarding the value for current to operate the subsystem clock in STOP mode, refer to that in HALT mode.
 9. Relationship between operation voltage width, operation frequency of CPU and operation mode is as below.

| | |
|----------------------------|--|
| HS (high-speed main) mode: | $2.7\text{ V} \leq V_{DD} \leq 5.5\text{ V}@1\text{ MHz to }24\text{ MHz}$ |
| | $2.4\text{ V} \leq V_{DD} \leq 5.5\text{ V}@1\text{ MHz to }16\text{ MHz}$ |

- Remarks**
1. f_{HOCO} : High-speed on-chip oscillator clock frequency (Max. 48 MHz)
 2. f_{IH} : Main system clock source frequency obtained by dividing the high-speed on-chip oscillator clock by 2, 4, or 8 (Max. 24 MHz)
 3. f_{MX} : High-speed system clock frequency (X1 clock oscillation frequency or external main system clock frequency)
 4. f_{PLL} : PLL oscillation frequency
 5. f_{SUB} : Subsystem clock frequency (XT1 clock oscillation frequency)
 6. f_{CLK} : CPU/peripheral hardware clock frequency
 7. Except subsystem clock operation, temperature condition of the TYP. value is $T_A = 25^\circ\text{C}$.

($T_A = -40$ to $+85^\circ\text{C}$, $2.4\text{ V} \leq V_{DD} \leq 5.5\text{ V}$, $V_{SS} = 0\text{ V}$) (1/2)

| Parameter | Symbol | Conditions | | MIN. | TYP. | MAX. | Unit |
|--|---------------------------------------|----------------------------------|--|------|------|-------|---------------|
| Low-speed on-chip oscillator operating current | I_{FIL} ^{Note 1} | | | | 0.20 | | μA |
| RTC operating current | I_{RTC} ^{Notes 1, 2, 3} | | | | 0.02 | | μA |
| 12-bit interval timer operating current | I_{IT} ^{Notes 1, 2, 4} | | | | 0.02 | | μA |
| Watchdog timer operating current | I_{WDT} ^{Notes 1, 2, 5} | $f_{IL} = 15\text{ kHz}$ | | | 0.22 | | μA |
| A/D converter operating current | I_{ADC} ^{Notes 1, 6} | When conversion at maximum speed | Normal mode, $AV_{REFP} = V_{DD} = 5.0\text{ V}$ | | 1.3 | 1.7 | mA |
| | | | Low voltage mode, $AV_{REFP} = V_{DD} = 3.0\text{ V}$ | | 0.5 | 0.7 | mA |
| A/D converter reference voltage current | I_{ADREF} ^{Note 1} | | | | 75.0 | | μA |
| Temperature sensor operating current | I_{TMPS} ^{Note 1} | | | | 75.0 | | μA |
| LVD operating current | I_{LVD} ^{Notes 1, 7} | | | | 0.08 | | μA |
| Self-programming operating current | I_{FSP} ^{Notes 1, 9} | | | | 2.00 | 12.20 | mA |
| BGO operating current | I_{BGO} ^{Notes 1, 8} | | | | 2.00 | 12.20 | mA |
| SNOOZE operating current | I_{SNOZ} ^{Note 1} | ADC operation | The mode is performed ^{Note 10} | | 0.50 | 1.06 | mA |
| | | | The A/D conversion operations are performed, Low voltage mode, $AV_{REFP} = V_{DD} = 3.0\text{ V}$ | | 1.20 | 1.62 | mA |
| | | CSI operation | | 0.70 | 0.84 | mA | |

(Notes and Remarks are listed on the next page.)

(T_A = -40 to +85°C, 2.4 V ≤ V_{DD} ≤ 5.5 V, V_{SS} = 0 V) (2/2)

| Parameter | Symbol | Conditions | MIN. | TYP. | MAX. | Unit |
|-----------------------|------------------------------|---|------|------|------|------|
| USB operating current | I _{USBH} Note 11 | During USB communication operation under the following settings and conditions (V _{DD} = 5.0 V, T _A = +25°C): <ul style="list-style-type: none"> • The internal power supply for the USB is used. • X1 oscillation frequency (f_x) = 12 MHz, PLL oscillation frequency (f_{PLL}) = 48 MHz • The host controller (via two ports) is set to operate in full-speed mode with four pipes (end points) used simultaneously. (PIPE4: Bulk OUT transfer (64 bytes), PIPE5: Bulk IN transfer (64 bytes), PIPE6: Interrupt OUT transfer, PIPE7: Interrupt IN transfer). • The USB ports (two ports) are individually connected to a peripheral function via a 0.5 m USB cable. | | 9.0 | | mA |
| | I _{USBF} Note 11 | During USB communication operation under the following settings and conditions (V _{DD} = 5.0 V, T _A = +25°C): <ul style="list-style-type: none"> • The internal power supply for the USB is used. • X1 oscillation frequency (f_x) = 12 MHz, PLL oscillation frequency (f_{PLL}) = 48 MHz • The function controller is set to operate in full-speed mode with four pipes (end points) used simultaneously. (PIPE4: Bulk OUT transfer (64 bytes), PIPE5: Bulk IN transfer (64 bytes), PIPE6: Interrupt OUT transfer, PIPE7: Interrupt IN transfer). • The USB port (one port) is connected to the host device via a 0.5 m USB cable. | | 2.5 | | mA |
| | I _{SUSP} Note 12 | During suspended state under the following settings and conditions (V _{DD} = 5.0 V, T _A = +25°C): <ul style="list-style-type: none"> • The function controller is set to full-speed mode (the UDP0 pin is pulled up). • The internal power supply for the USB is used. • The system is set to STOP mode (When the high-speed on-chip oscillator, high-speed system clock, and subsystem clock are stopped. When the watchdog timer is stopped.). • The USB port (one port) is connected to the host device via a 0.5 m USB cable. | | 240 | | μA |

(Notes and Remarks are listed on the next page.)

- Notes**
1. Current flowing to V_{DD} .
 2. When high speed on-chip oscillator and high-speed system clock are stopped.
 3. Current flowing only to the real-time clock (RTC) (excluding the operating current of the low-speed on-chip oscillator and the XT1 oscillator). The supply current of the RL78 microcontrollers is the sum of the values of either I_{DD1} or I_{DD2} , and I_{RTC} , when the real-time clock operates in operation mode or HALT mode. When the low-speed on-chip oscillator is selected, I_{FIL} should be added. I_{DD2} subsystem clock operation includes the operational current of the real-time clock.
 4. Current flowing only to the 12-bit interval timer (excluding the operating current of the low-speed on-chip oscillator and the XT1 oscillator). The supply current of the RL78 microcontrollers is the sum of the values of either I_{DD1} or I_{DD2} , and I_{IT} , when the 12-bit interval timer operates in operation mode or HALT mode. When the low-speed on-chip oscillator is selected, I_{FIL} should be added.
 5. Current flowing only to the watchdog timer (including the operating current of the low-speed on-chip oscillator). The supply current of the RL78 microcontrollers is the sum of I_{DD1} , I_{DD2} or I_{DD3} and I_{WDT} when the watchdog timer is in operation.
 6. Current flowing only to the A/D converter. The supply current of the RL78 microcontrollers is the sum of I_{DD1} or I_{DD2} and I_{ADC} when the A/D converter operates in an operation mode or the HALT mode.
 7. Current flowing only to the LVD circuit. The current value of the RL78/G1C is the sum of I_{DD1} , I_{DD2} or I_{DD3} and I_{LVI} when the LVD circuit operates in the Operating, HALT or STOP mode.
 8. Current flowing only during data flash rewrite.
 9. Current flowing only during self programming.
 10. For shift time to the SNOOZE mode.
 11. Current consumed only by the USB module and the internal power supply for the USB.
 12. Includes the current supplied from the pull-up resistor of the UDP0 pin to the pull-down resistor of the host device, in addition to the current consumed by this MCU during the suspended state.

- Remarks**
1. f_{IL} : Low-speed on-chip oscillator clock frequency
 2. f_{SUB} : Subsystem clock frequency (XT1 clock oscillation frequency)
 3. f_{CLK} : CPU/peripheral hardware clock frequency
 4. Temperature condition of the TYP. value is $T_A = 25^{\circ}\text{C}$

2.4 AC Characteristics

2.4.1 Basic operation

(T_A = -40 to +85°C, 2.4 V ≤ V_{DD} ≤ 5.5 V, V_{SS} = 0 V)

| Items | Symbol | Conditions | | MIN. | TYP. | MAX. | Unit | |
|---|---------------------------------------|--|---------------------------------|---------------------------------|---------|------|------|----|
| Instruction cycle (minimum instruction execution time) | t _{CY} | Main system clock (f _{MAIN}) operation | HS (High-speed main) mode | 2.7 V ≤ V _{DD} ≤ 5.5 V | 0.04167 | | 1 | μs |
| | | | | 2.4 V ≤ V _{DD} < 2.7 V | 0.0625 | | 1 | μs |
| | | Subsystem clock (f _{SUB}) operation | | 2.4 V ≤ V _{DD} ≤ 5.5 V | 28.5 | 30.5 | 31.3 | μs |
| | | In the self programming mode | HS (High-speed main) mode | 2.7 V ≤ V _{DD} ≤ 5.5 V | 0.04167 | | 1 | μs |
| | 2.4 V ≤ V _{DD} < 2.7 V | | 0.0625 | | 1 | μs | | |
| External system clock frequency | f _{EX} | 2.7 V ≤ V _{DD} ≤ 5.5 V | | 1.0 | | 20.0 | MHz | |
| | | 2.4 V ≤ V _{DD} < 2.7 V | | 1.0 | | 16.0 | MHz | |
| | f _{EXS} | | | 32 | | 35 | kHz | |
| External system clock input high-level width, low-level width | t _{EXH} , t _{EXL} | 2.7 V ≤ V _{DD} ≤ 5.5 V | | 24 | | | ns | |
| | | 2.4 V ≤ V _{DD} < 2.7 V | | 30 | | | ns | |
| | t _{EXHS} , t _{EXLS} | | | 13.7 | | | μs | |
| TI00 to TI03 input high-level width, low-level width | t _{TIH} , t _{TIL} | | | 1/f _{MCK} +10 | | | ns | |
| TO00 to TO03 output frequency | f _{TO} | High-speed main mode | 4.0 V ≤ V _{DD} ≤ 5.5 V | | | 12 | MHz | |
| | | | 2.7 V ≤ V _{DD} < 4.0 V | | | 8 | MHz | |
| | | | 2.4 V ≤ V _{DD} < 2.7 V | | | 4 | MHz | |
| PCLBUZ0, PCLBUZ1 output frequency | f _{PCL} | High-speed main mode | 4.0 V ≤ V _{DD} ≤ 5.5 V | | | 16 | MHz | |
| | | | 2.7 V ≤ V _{DD} < 4.0 V | | | 8 | MHz | |
| | | | 2.4 V ≤ V _{DD} < 2.7 V | | | 4 | MHz | |
| Interrupt input high-level width, low-level width | t _{INTH} , t _{INTL} | INTP0 to INTP6, INTP8, INTP9 | 2.4 V ≤ V _{DD} ≤ 5.5 V | 1 | | | μs | |
| Key interrupt input low-level width | t _{KR} | KR0 to KR5 | 2.4 V ≤ V _{DD} ≤ 5.5 V | 250 | | | ns | |
| RESET low-level width | t _{RSL} | | | 10 | | | μs | |

Remark f_{MCK}: Timer array unit operation clock frequency

(Operation clock to be set by the CKS0n bit of timer mode register 0n (TMR0n). n: Channel number (n = 0 to 3))

Minimum Instruction Execution Time during Main System Clock Operation

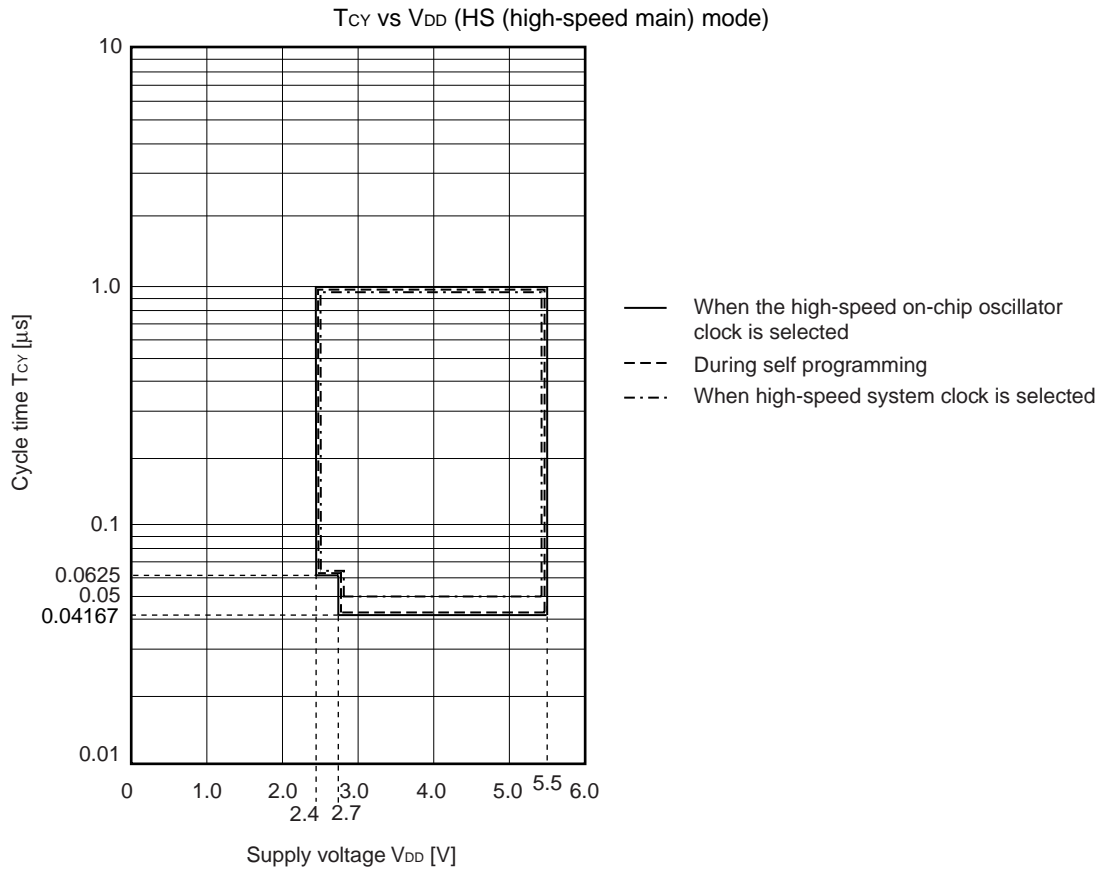

AC Timing Test Points

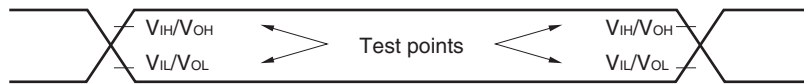

External System Clock Timing

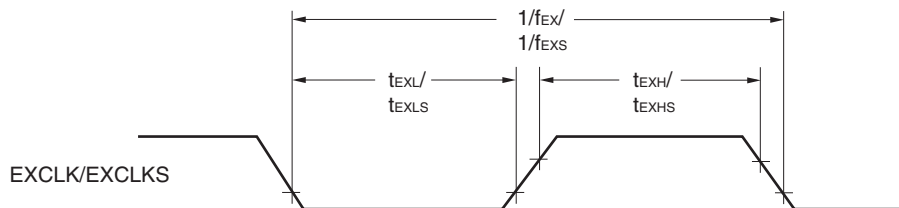

TI/TO Timing

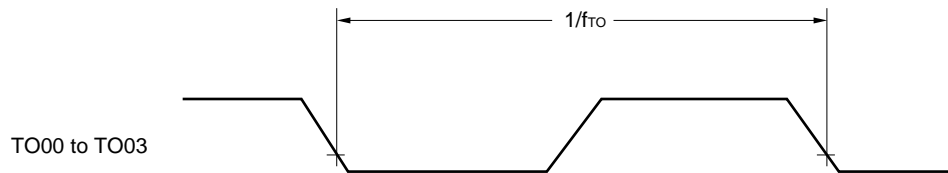
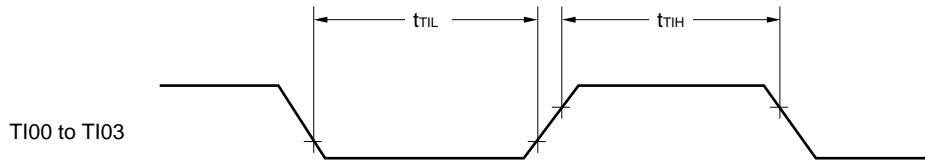

Interrupt Request Input Timing

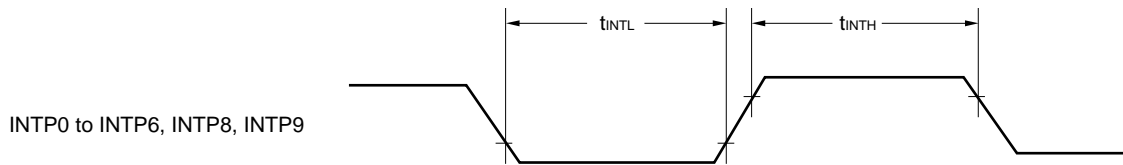

Key Interrupt Input Timing

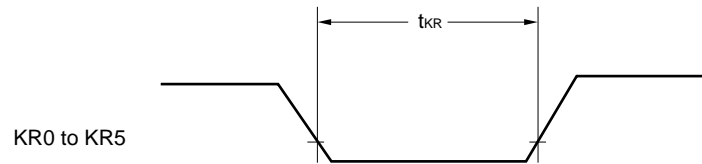

RESET Input Timing

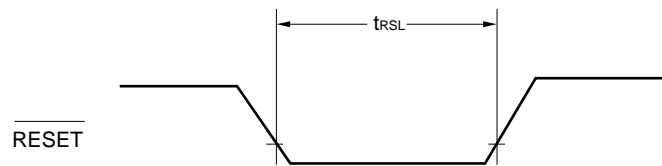

2.5 Peripheral Functions Characteristics

2.5.1 Serial array unit

(1) During communication at same potential (UART mode) (dedicated baud rate generator output)

(T_A = -40 to +85°C, 2.4 V ≤ V_{DD} ≤ 5.5 V, V_{SS} = 0 V)

| Parameter | Symbol | Conditions | MIN. | TYP. | MAX. | Unit |
|---------------|--------|---|------|------|---------------------|------|
| Transfer rate | | | | | f _{MCK} /6 | bps |
| | | Theoretical value of the maximum transfer rate f _{MCK} = f _{CLK} <small>Note</small> | | | 4.0 | Mbps |

Note The maximum operating frequencies of the CPU/peripheral hardware clock (f_{CLK}) are:

HS (high-speed main) mode: 24 MHz (2.7 V ≤ V_{DD} ≤ 5.5 V)

16 MHz (2.4 V ≤ V_{DD} ≤ 5.5 V)

Caution Select the normal input buffer for the RxDq pin and the normal output mode for the TxDq pin by using port input mode register g (PIMg) and port output mode register g (POMg).

UART mode connection diagram (during communication at same potential)

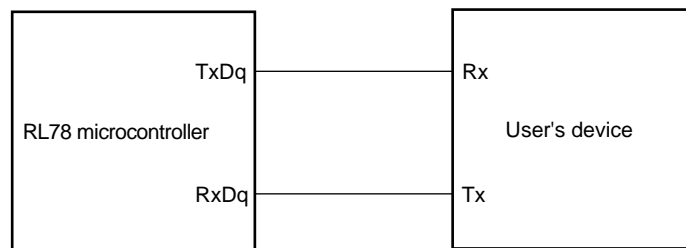

UART mode bit width (during communication at same potential) (reference)

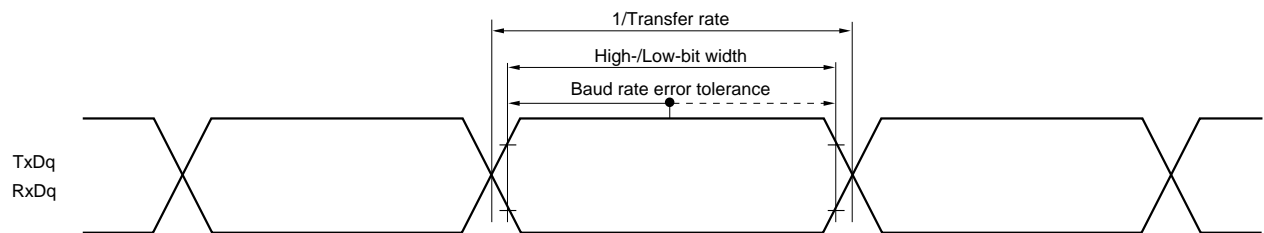

- Remarks**
- q: UART number (q = 0), g: PIM and POM number (g = 5)
 - f_{MCK}: Serial array unit operation clock frequency
(Operation clock to be set by the CKSmn bit of serial mode register mn (SMRmn). m: Unit number, n: Channel number (mn = 00))

(2) During communication at same potential (CSI mode) (master mode, SCKp... internal clock output, corresponding CSI00 only)**(T_A = -40 to +85°C, 2.7 V ≤ V_{DD} ≤ 5.5 V, V_{SS} = 0 V)**

| Parameter | Symbol | Conditions | MIN. | TYP. | MAX. | Unit |
|---|--------------------|--|---------------------------|------|------|------|
| SCKp cycle time | t _{KCY1} | t _{KCY1} ≥ 2/f _{CLK} 2.7 V ≤ V _{DD} ≤ 5.5 V | 83.3 | | | ns |
| SCKp high-/low-level width | t _{KH1} , | 4.0 V ≤ V _{DD} ≤ 5.5 V | t _{KCY1} /2 - 7 | | | ns |
| | t _{KL1} | 2.7 V ≤ V _{DD} ≤ 5.5 V | t _{KCY1} /2 - 10 | | | ns |
| Slp setup time (to SCKp↑) ^{Note 1} | t _{SIK1} | 4.0 V ≤ V _{DD} ≤ 5.5 V | 23 | | | ns |
| | | 2.7 V ≤ V _{DD} ≤ 5.5 V | 33 | | | ns |
| Slp hold time (from SCKp↑) ^{Note 2} | t _{KSH1} | 2.7 V ≤ V _{DD} ≤ 5.5 V | 10 | | | ns |
| Delay time from SCKp↓ to SOp output ^{Note 3} | t _{KSO1} | C = 20 pF ^{Note 3} | | | 10 | ns |

- Notes**
1. When DAP_{mn} = 0 and CKP_{mn} = 0, or DAP_{mn} = 1 and CKP_{mn} = 1. The Slp setup time becomes “to SCKp↓” when DAP_{mn} = 0 and CKP_{mn} = 1, or DAP_{mn} = 1 and CKP_{mn} = 0.
 2. When DAP_{mn} = 0 and CKP_{mn} = 0, or DAP_{mn} = 1 and CKP_{mn} = 1. The Slp hold time becomes “from SCKp↓” when DAP_{mn} = 0 and CKP_{mn} = 1, or DAP_{mn} = 1 and CKP_{mn} = 0.
 3. When DAP_{mn} = 0 and CKP_{mn} = 0, or DAP_{mn} = 1 and CKP_{mn} = 1. The delay time to SOp output becomes “from SCKp↑” when DAP_{mn} = 0 and CKP_{mn} = 1, or DAP_{mn} = 1 and CKP_{mn} = 0.
 4. C is the load capacitance of the SCKp and SOp output lines.

Caution Select the normal input buffer for the Slp pin and the normal output mode for the SOp pin and SCKp pin by using port input mode register g (PIMg) and port output mode register g (POMg).

- Remarks**
1. This specification is valid only when CSI00's peripheral I/O redirect function is not used.
 2. p: CSI number (p = 00), m: Unit number (m = 0), n: Channel number (n = 0),
g: PIM and POM numbers (g = 3, 5)
 3. f_{MCK}: Serial array unit operation clock frequency
(Operation clock to be set by the CKS_{mn} bit of serial mode register mn (SMR_{mn}). m: Unit number,
n: Channel number (mn = 00))

(3) During communication at same potential (CSI mode) (master mode, SCKp... internal clock output)**($T_A = -40$ to $+85^\circ\text{C}$, $2.4\text{ V} \leq V_{DD} \leq 5.5\text{ V}$, $V_{SS} = 0\text{ V}$)**

| Parameter | Symbol | Conditions | MIN. | TYP. | MAX. | Unit |
|---|--------------------------|--|--|-------------------|------|------|
| SCKp cycle time | t_{KCY1} | $t_{KCY1} \geq 4/f_{CLK}$ | $2.7\text{ V} \leq V_{DD} \leq 5.5\text{ V}$ | 167 | | ns |
| | | | $2.4\text{ V} \leq V_{DD} \leq 5.5\text{ V}$ | 250 | | ns |
| SCKp high-/low-level width | t_{KH1} , t_{KL1} | $4.0\text{ V} \leq V_{DD} \leq 5.5\text{ V}$ | | $t_{KCY1}/2 - 12$ | | ns |
| | | $2.7\text{ V} \leq V_{DD} \leq 5.5\text{ V}$ | | $t_{KCY1}/2 - 18$ | | ns |
| | | $2.4\text{ V} \leq V_{DD} \leq 5.5\text{ V}$ | | $t_{KCY1}/2 - 38$ | | ns |
| Slp setup time (to SCKp \uparrow) ^{Note 1} | t_{SIK1} | $4.0\text{ V} \leq V_{DD} \leq 5.5\text{ V}$ | | 44 | | ns |
| | | $2.7\text{ V} \leq V_{DD} \leq 5.5\text{ V}$ | | 44 | | ns |
| | | $2.4\text{ V} \leq V_{DD} \leq 5.5\text{ V}$ | | 75 | | ns |
| Slp hold time (from SCKp \uparrow) ^{Note 2} | t_{KSI1} | | 19 | | | ns |
| Delay time from SCKp \downarrow to SOp output ^{Note 3} | t_{KSO1} | $C = 30\text{ pF}$ ^{Note 4} | | | 25 | ns |

Notes 1. When $DAP_{mn} = 0$ and $CKP_{mn} = 0$, or $DAP_{mn} = 1$ and $CKP_{mn} = 1$. The Slp setup time becomes “to SCKp \downarrow ” when $DAP_{mn} = 0$ and $CKP_{mn} = 1$, or $DAP_{mn} = 1$ and $CKP_{mn} = 0$.

2. When $DAP_{mn} = 0$ and $CKP_{mn} = 0$, or $DAP_{mn} = 1$ and $CKP_{mn} = 1$. The Slp hold time becomes “from SCKp \downarrow ” when $DAP_{mn} = 0$ and $CKP_{mn} = 1$, or $DAP_{mn} = 1$ and $CKP_{mn} = 0$.

3. When $DAP_{mn} = 0$ and $CKP_{mn} = 0$, or $DAP_{mn} = 1$ and $CKP_{mn} = 1$. The delay time to SOp output becomes “from SCKp \uparrow ” when $DAP_{mn} = 0$ and $CKP_{mn} = 1$, or $DAP_{mn} = 1$ and $CKP_{mn} = 0$.

4. C is the load capacitance of the SCKp and SOp output lines.

Caution Select the normal input buffer for the Slp pin and the normal output mode for the SOp pin and SCKp pin by using port input mode register g (PIMg) and port output mode register g (POMg).

Remarks 1. p: CSI number (p = 00, 01), m: Unit number (m = 0), n: Channel number (n = 0, 1),
g: PIM and POM numbers (g = 0, 3, 5, 7)

2. f_{MCK} : Serial array unit operation clock frequency

(Operation clock to be set by the CKS $_{mn}$ bit of serial mode register mn (SMR $_{mn}$). m: Unit number,
n: Channel number (mn = 00, 01))

(4) During communication at same potential (CSI mode) (slave mode, SCKp... external clock input)**($T_A = -40$ to $+85^\circ\text{C}$, $2.4\text{ V} \leq V_{DD} \leq 5.5\text{ V}$, $V_{SS} = 0\text{ V}$)**

| Parameter | Symbol | Conditions | MIN. | TYP. | MAX. | Unit |
|--|--------------------------|--|--|-------------|------------------|------|
| SCKp cycle time ^{Note 5} | t_{KCY2} | $4.0\text{ V} \leq V_{DD} \leq 5.5\text{ V}$ | $20\text{ MHz} < f_{MCK}$ | $8/f_{MCK}$ | | ns |
| | | | $f_{MCK} \leq 20\text{ MHz}$ | $6/f_{MCK}$ | | ns |
| | | $2.7\text{ V} \leq V_{DD} \leq 5.5\text{ V}$ | $16\text{ MHz} < f_{MCK}$ | $8/f_{MCK}$ | | ns |
| | | | $f_{MCK} \leq 16\text{ MHz}$ | $6/f_{MCK}$ | | ns |
| | | $2.4\text{ V} \leq V_{DD} \leq 5.5\text{ V}$ | $6/f_{MCK}$ and 500 | | ns | |
| SCKp high-/low-level width | t_{KH2} , t_{KL2} | $4.0\text{ V} \leq V_{DD} \leq 5.5\text{ V}$ | $t_{KCY2}/2 - 7$ | | ns | |
| | | $2.7\text{ V} \leq V_{DD} \leq 5.5\text{ V}$ | $t_{KCY2}/2 - 8$ | | ns | |
| | | $2.4\text{ V} \leq V_{DD} \leq 5.5\text{ V}$ | $t_{KCY2}/2 - 18$ | | ns | |
| Slp setup time (to SCKp \uparrow) ^{Note 1} | t_{SIK2} | $2.7\text{ V} \leq V_{DD} \leq 5.5\text{ V}$ | $1/f_{MCK} + 20$ | | ns | |
| | | $2.4\text{ V} \leq V_{DD} \leq 5.5\text{ V}$ | $1/f_{MCK} + 30$ | | ns | |
| Slp hold time (from SCKp \uparrow) ^{Note 2} | t_{SIL2} | $2.7\text{ V} \leq V_{DD} \leq 5.5\text{ V}$ | $1/f_{MCK} + 31$ | | ns | |
| | | $2.4\text{ V} \leq V_{DD} \leq 5.5\text{ V}$ | $1/f_{MCK} + 31$ | | ns | |
| Delay time from SCKp \downarrow to SOp output ^{Note 3} | t_{KSO2} | $C = 30\text{ pF}$ ^{Note 4} | $2.7\text{ V} \leq V_{DD} \leq 5.5\text{ V}$ | | $2/f_{MCK} + 44$ | ns |
| | | | $2.4\text{ V} \leq V_{DD} \leq 5.5\text{ V}$ | | $2/f_{MCK} + 75$ | ns |

- Notes**
- When $DAP_{mn} = 0$ and $CKP_{mn} = 0$, or $DAP_{mn} = 1$ and $CKP_{mn} = 1$. The Slp setup time becomes “to SCKp \downarrow ” when $DAP_{mn} = 0$ and $CKP_{mn} = 1$, or $DAP_{mn} = 1$ and $CKP_{mn} = 0$.
 - When $DAP_{mn} = 0$ and $CKP_{mn} = 0$, or $DAP_{mn} = 1$ and $CKP_{mn} = 1$. The Slp hold time becomes “from SCKp \downarrow ” when $DAP_{mn} = 0$ and $CKP_{mn} = 1$, or $DAP_{mn} = 1$ and $CKP_{mn} = 0$.
 - When $DAP_{mn} = 0$ and $CKP_{mn} = 0$, or $DAP_{mn} = 1$ and $CKP_{mn} = 1$. The delay time to SOp output becomes “from SCKp \uparrow ” when $DAP_{mn} = 0$ and $CKP_{mn} = 1$, or $DAP_{mn} = 1$ and $CKP_{mn} = 0$.
 - C is the load capacitance of the SOp output lines.
 - Transfer rate in the SNOOZE mode : MAX. 1 Mbps

Caution Select the normal input buffer for the Slp pin and SCKp pin and the normal output mode for the SOp pin by using port input mode register g (PIMg) and port output mode register g (POMg).

- Remarks**
- p : CSI number ($p = 00, 01$), m : Unit number ($m = 0$),
 n : Channel number ($n = 0, 1$), g : PIM number ($g = 0, 3, 5, 7$)
 - f_{MCK} : Serial array unit operation clock frequency
(Operation clock to be set by the CKSmn bit of serial mode register mn (SMRmn). m : Unit number,
 n : Channel number ($mn = 00, 01$))

CSI mode connection diagram (during communication at same potential)

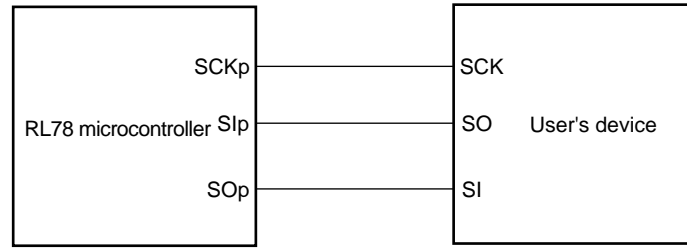

**CSI mode serial transfer timing (during communication at same potential)
(When DAPmn = 0 and CKPmn = 0, or DAPmn = 1 and CKPmn = 1.)**

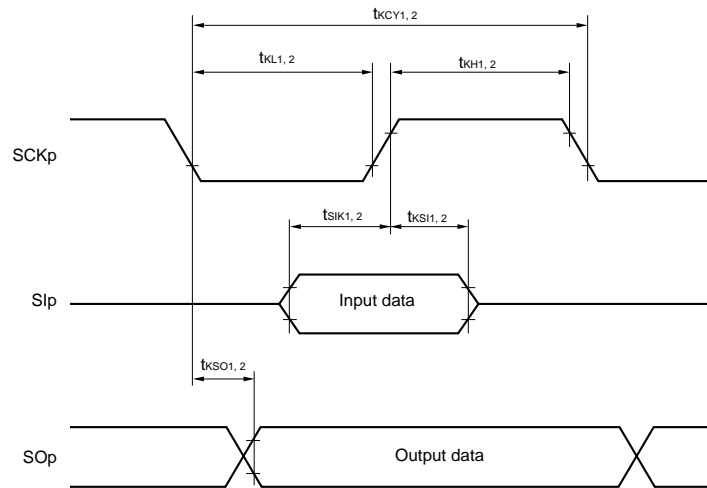

**CSI mode serial transfer timing (during communication at same potential)
(When DAPmn = 0 and CKPmn = 1, or DAPmn = 1 and CKPmn = 0.)**

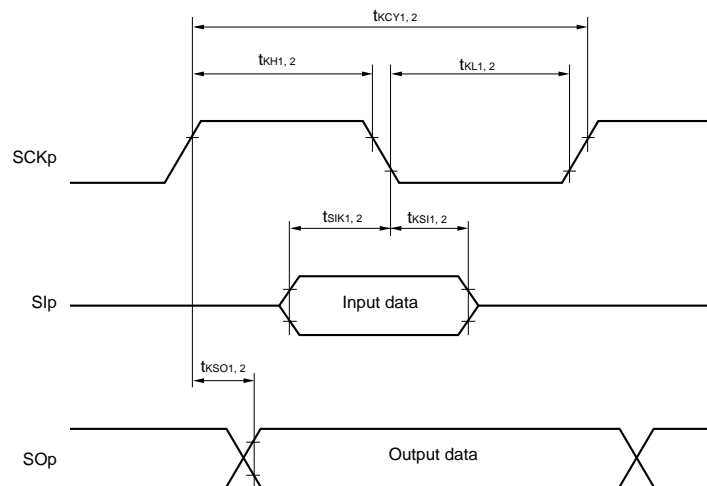

- Remarks**
1. p: CSI number (p = 00, 01)
 2. m: Unit number, n: Channel number (mn = 00, 01)

(5) During communication at same potential (simplified I²C mode)**(T_A = -40 to +85°C, 2.4 V ≤ V_{DD} ≤ 5.5 V, V_{SS} = 0 V)**

| Parameter | Symbol | Conditions | MIN. | MAX. | Unit |
|-------------------------------|---------------------|---|--|------------------------|------|
| SCLr clock frequency | f _{SCL} | 2.7 V ≤ V _{DD} ≤ 5.5 V, C _b = 50 pF, R _b = 2.7 kΩ | | 1000 ^{Note 1} | kHz |
| | | 2.4 V ≤ V _{DD} ≤ 5.5 V, C _b = 100 pF, R _b = 3 kΩ | | 400 ^{Note 1} | kHz |
| | | 2.4 V ≤ V _{DD} < 2.7 V, C _b = 100 pF, R _b = 5 kΩ | | 300 ^{Note 1} | kHz |
| Hold time when SCLr = "L" | t _{LOW} | 2.7 V ≤ V _{DD} ≤ 5.5 V, C _b = 50 pF, R _b = 2.7 kΩ | 475 | | ns |
| | | 2.4 V ≤ V _{DD} ≤ 5.5 V, C _b = 100 pF, R _b = 3 kΩ | 1150 | | ns |
| | | 2.4 V ≤ V _{DD} < 2.7 V, C _b = 100 pF, R _b = 5 kΩ | 1550 | | ns |
| Hold time when SCLr = "H" | t _{HIGH} | 2.7 V ≤ V _{DD} ≤ 5.5 V, C _b = 50 pF, R _b = 2.7 kΩ | 475 | | ns |
| | | 2.4 V ≤ V _{DD} ≤ 5.5 V, C _b = 100 pF, R _b = 3 kΩ | 1150 | | ns |
| | | 2.4 V ≤ V _{DD} < 2.7 V, C _b = 100 pF, R _b = 5 kΩ | 1550 | | ns |
| Data setup time (reception) | t _{SU:DAT} | 2.7 V ≤ V _{DD} ≤ 5.5 V, C _b = 50 pF, R _b = 2.7 kΩ | 1/f _{MCK} + 85 ^{Note 2} | | ns |
| | | 2.4 V ≤ V _{DD} ≤ 5.5 V, C _b = 100 pF, R _b = 3 kΩ | 1/f _{MCK} + 145 ^{Note 2} | | ns |
| | | 2.4 V ≤ V _{DD} < 2.7 V, C _b = 100 pF, R _b = 5 kΩ | 1/f _{MCK} + 230 ^{Note 2} | | ns |
| Data hold time (transmission) | t _{HD:DAT} | 2.7 V ≤ V _{DD} ≤ 5.5 V, C _b = 50 pF, R _b = 2.7 kΩ | 0 | 305 | ns |
| | | 2.4 V ≤ V _{DD} ≤ 5.5 V, C _b = 100 pF, R _b = 3 kΩ | 0 | 355 | ns |
| | | 2.4 V ≤ V _{DD} < 2.7 V, C _b = 100 pF, R _b = 5 kΩ | 0 | 405 | ns |

Notes 1. The value must also be equal to or less than f_{MCK}/4.

2. Set the f_{MCK} value to keep the hold time of SCLr = "L" and SCLr = "H".

Caution Select the normal input buffer and the N-ch open drain output (V_{DD} tolerance) mode for the SDAr pin and the normal output mode for the SCLr pin by using port input mode register g (PIMg) and port output mode register h (POMh).

(Caution and Remarks are listed on the next page.)

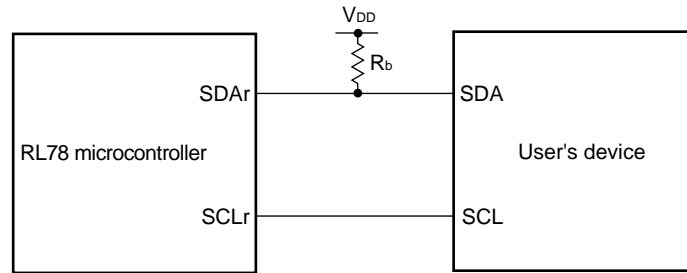
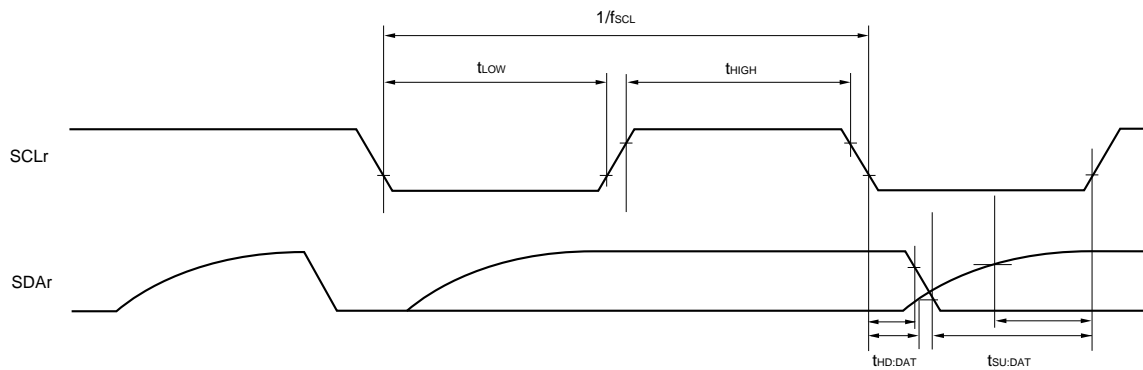
Simplified I²C mode connection diagram (during communication at same potential)**Simplified I²C mode serial transfer timing (during communication at same potential)**

- Remarks**
- $R_b[\Omega]$: Communication line (SDAr) pull-up resistance, $C_b[F]$: Communication line (SDAr, SCLr) load capacitance
 - r: IIC number (r = 00, 01), g: PIM number (g = 5), h: POM number (h = 3, 5)
 - f_{MCK} : Serial array unit operation clock frequency
(Operation clock to be set by the CKSmn bit of serial mode register mn (SMRmn). m: Unit number (m = 0), n: Channel number (n = 0, 1), mn = 00, 01)

(6) Communication at different potential (2.5 V, 3 V) (UART mode) (1/2)**(T_A = -40 to +85°C, 2.4 V ≤ V_{DD} ≤ 5.5 V, V_{SS} = 0 V)**

| Parameter | Symbol | Conditions | | MIN. | TYP. | MAX. | Unit | |
|--|---|------------|--|---|------|------|-----------------------------------|-----|
| Transfer rate | | reception | 4.0 V ≤ V _{DD} ≤ 5.5 V, 2.7 V ≤ V _b ≤ 4.0 V | Theoretical value of the maximum transfer rate f _{MCK} = f _{CLK} Note 2 | | | f _{MCK} /6 Note 1 | bps |
| | | | | | | 4.0 | Mbps | |
| | | | 2.7 V ≤ V _{DD} < 4.0 V, 2.3 V ≤ V _b ≤ 2.7 V | Theoretical value of the maximum transfer rate f _{MCK} = f _{CLK} Note 2 | | | f _{MCK} /6 Note 1 | bps |
| | | | | | | 4.0 | Mbps | |
| 2.4 V ≤ V _{DD} < 3.3 V, 1.6 V ≤ V _b ≤ 2.0 V | Theoretical value of the maximum transfer rate f _{MCK} = f _{CLK} Note 2 | | | f _{MCK} /6 Note 1 | bps | | | |
| | | | 4.0 | Mbps | | | | |

Notes 1. Use it with V_{DD} ≥ V_b.**2.** The maximum operating frequencies of the CPU/peripheral hardware clock (f_{CLK}) are:HS (high-speed main) mode: 24 MHz (2.7 V ≤ V_{DD} ≤ 5.5 V)16 MHz (2.4 V ≤ V_{DD} ≤ 5.5 V)

Caution Select the TTL input buffer for the RxDq pin and the N-ch open drain output (V_{DD} tolerance) mode for the TxDq pin by using port input mode register g (PIMg) and port output mode register g (POMg). For V_{IH} and V_{IL}, see the DC characteristics with TTL input buffer selected.

Remarks 1. V_b[V]: Communication line voltage**2.** q: UART number (q = 0), g: PIM and POM number (g = 5)**3.** f_{MCK}: Serial array unit operation clock frequency(Operation clock to be set by the CKS_{mn} bit of serial mode register mn (SMR_{mn}). m: Unit number,

n: Channel number (mn = 00)

(6) Communication at different potential (2.5 V, 3 V) (UART mode) (2/2)**(T_A = -40 to +85°C, 2.4 V ≤ V_{DD} ≤ 5.5 V, V_{SS} = 0 V)**

| Parameter | Symbol | Conditions | | MIN. | TYP. | MAX. | Unit | |
|---------------|--------|--------------|----------------------------------|---|------|---------------|--------------------|------|
| Transfer rate | | transmission | 4.0 V ≤ V _{DD} ≤ 5.5 V, | | | Note 1 | bps | |
| | | | 2.7 V ≤ V _b ≤ 4.0 V | Theoretical value of the maximum transfer rate C _b = 50 pF, R _b = 1.4 kΩ, V _b = 2.7 V | | | 2.8 Note 2 | Mbps |
| | | | 2.7 V ≤ V _{DD} < 4.0 V | | | | Note 3 | bps |
| | | | 2.3 V ≤ V _b ≤ 2.7 V | Theoretical value of the maximum transfer rate C _b = 50 pF, R _b = 2.7 kΩ, V _b = 2.3 V | | | 1.2 Note 4 | Mbps |
| | | | 2.4 V ≤ V _{DD} < 3.3 V | | | | Notes 5, 6 | bps |
| | | | 1.6 V ≤ V _b ≤ 2.0 V | Theoretical value of the maximum transfer rate C _b = 50 pF, R _b = 5.5 kΩ, V _b = 1.6 V | | | 0.43 Note 7 | Mbps |

Notes 1. The smaller maximum transfer rate derived by using f_{MCK}/6 or the following expression is the valid maximum transfer rate.

Expression for calculating the transfer rate when 4.0 V ≤ V_{DD} ≤ 5.5 V and 2.7 V ≤ V_b ≤ 4.0 V

$$\text{Maximum transfer rate} = \frac{1}{\{-C_b \times R_b \times \ln(1 - \frac{2.2}{V_b})\} \times 3} \text{ [bps]}$$

$$\text{Baud rate error (theoretical value)} = \frac{\frac{1}{\text{Transfer rate} \times 2} - \{-C_b \times R_b \times \ln(1 - \frac{2.2}{V_b})\}}{(\frac{1}{\text{Transfer rate}}) \times \text{Number of transferred bits}} \times 100 \text{ [%]}$$

* This value is the theoretical value of the relative difference between the transmission and reception sides.

2. This value as an example is calculated when the conditions described in the “Conditions” column are met. Refer to Note 1 above to calculate the maximum transfer rate under conditions of the customer.

3. The smaller maximum transfer rate derived by using f_{MCK}/6 or the following expression is the valid maximum transfer rate.

Expression for calculating the transfer rate when 2.7 V ≤ V_{DD} < 4.0 V and 2.3 V ≤ V_b ≤ 2.7 V

$$\text{Maximum transfer rate} = \frac{1}{\{-C_b \times R_b \times \ln(1 - \frac{2.0}{V_b})\} \times 3} \text{ [bps]}$$

$$\text{Baud rate error (theoretical value)} = \frac{\frac{1}{\text{Transfer rate} \times 2} - \{-C_b \times R_b \times \ln(1 - \frac{2.0}{V_b})\}}{(\frac{1}{\text{Transfer rate}}) \times \text{Number of transferred bits}} \times 100 \text{ [%]}$$

* This value is the theoretical value of the relative difference between the transmission and reception sides.

4. This value as an example is calculated when the conditions described in the “Conditions” column are met. Refer to Note 3 above to calculate the maximum transfer rate under conditions of the customer.

5. Use it with V_{DD} ≥ V_b.

Notes 6. The smaller maximum transfer rate derived by using $f_{MCK}/6$ or the following expression is the valid maximum transfer rate.

Expression for calculating the transfer rate when $2.4\text{ V} \leq V_{DD} < 3.3\text{ V}$ and $1.6\text{ V} \leq V_b \leq 2.0\text{ V}$

$$\text{Maximum transfer rate} = \frac{1}{\{-C_b \times R_b \times \ln(1 - \frac{1.5}{V_b})\} \times 3} \text{ [bps]}$$

$$\text{Baud rate error (theoretical value)} = \frac{\frac{1}{\text{Transfer rate} \times 2} - \{-C_b \times R_b \times \ln(1 - \frac{1.5}{V_b})\}}{(\frac{1}{\text{Transfer rate}}) \times \text{Number of transferred bits}} \times 100 \text{ [%]}$$

* This value is the theoretical value of the relative difference between the transmission and reception sides.

7. This value as an example is calculated when the conditions described in the “Conditions” column are met. Refer to Note 6 above to calculate the maximum transfer rate under conditions of the customer.

Caution Select the TTL input buffer for the RxDq pin and the N-ch open drain output (V_{DD} tolerance) mode for the TxDq pin by using port input mode register g (PIMg) and port output mode register g (POMg). For V_{IH} and V_{IL}, see the DC characteristics with TTL input buffer selected.

UART mode connection diagram (during communication at different potential)

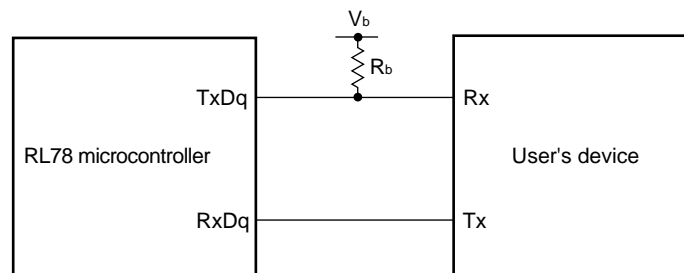

UART mode bit width (during communication at different potential) (reference)

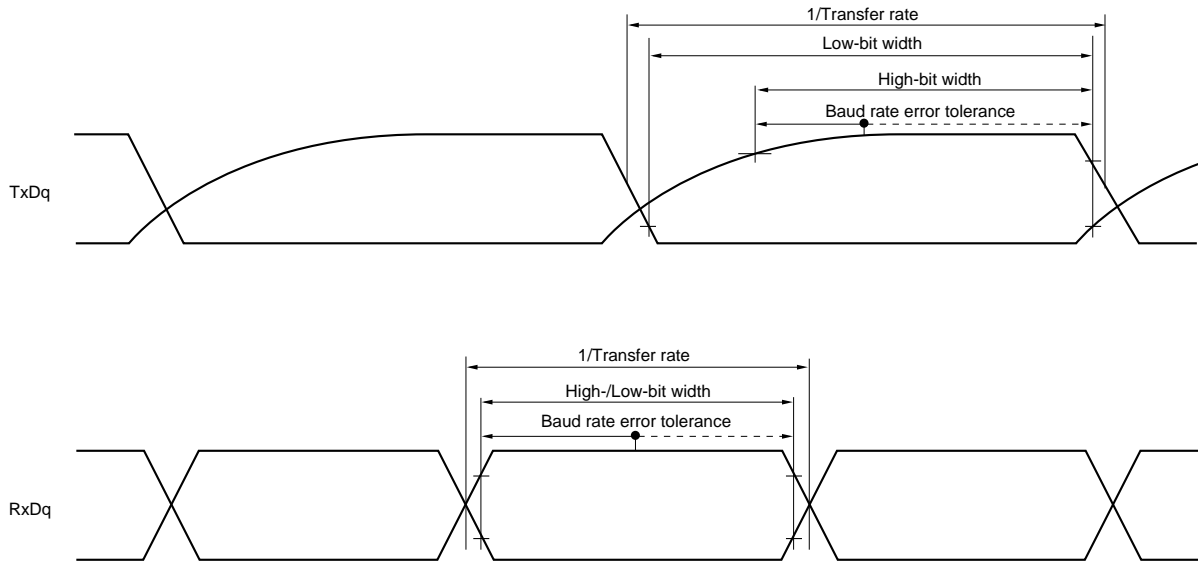

- Remarks**
1. $R_b[\Omega]$: Communication line (TxDq) pull-up resistance, $C_b[F]$: Communication line (TxDq) load capacitance, $V_b[V]$: Communication line voltage
 2. q: UART number ($q = 0$), g: PIM and POM number ($g = 5$)
 3. f_{MCK} : Serial array unit operation clock frequency
(Operation clock to be set by the CKSmn bit of serial mode register mn (SMRmn).
m: Unit number, n: Channel number ($mn = 00$))

(7) Communication at different potential (2.5 V, 3 V) (CSI mode) (master mode, SCKp... internal clock output, corresponding CSI00 only)**(T_A = -40 to +85°C, 2.4 V ≤ V_{DD} ≤ 5.5 V, V_{SS} = 0 V)**

| Parameter | Symbol | Conditions | MIN. | TYP. | MAX. | Unit |
|--|-------------------|--|----------------------------|------|------|------|
| SCKp cycle time | t _{KCY1} | t _{KCY1} ≥ 2/f _{CLK} 4.0 V ≤ V _{DD} ≤ 5.5 V, 2.7 V ≤ V _b ≤ 4.0 V, C _b = 20 pF, R _b = 1.4 kΩ | 200 | | | ns |
| | | 2.7 V ≤ V _{DD} < 4.0 V, 2.3 V ≤ V _b ≤ 2.7 V, C _b = 20 pF, R _b = 2.7 kΩ | 300 | | | ns |
| SCKp high-level width | t _{KH1} | 4.0 V ≤ V _{DD} ≤ 5.5 V, 2.7 V ≤ V _b ≤ 4.0 V, C _b = 20 pF, R _b = 1.4 kΩ | t _{KCY1} /2 - 50 | | | ns |
| | | 2.7 V ≤ V _{DD} < 4.0 V, 2.3 V ≤ V _b ≤ 2.7 V, C _b = 20 pF, R _b = 2.7 kΩ | t _{KCY1} /2 - 120 | | | ns |
| SCKp low-level width | t _{KL1} | 4.0 V ≤ V _{DD} ≤ 5.5 V, 2.7 V ≤ V _b ≤ 4.0 V, C _b = 20 pF, R _b = 1.4 kΩ | t _{KCY1} /2 - 7 | | | ns |
| | | 2.7 V ≤ V _{DD} < 4.0 V, 2.3 V ≤ V _b ≤ 2.7 V, C _b = 20 pF, R _b = 2.7 kΩ | t _{KCY1} /2 - 10 | | | ns |
| Slp setup time (to SCKp↑) ^{Note 1} | t _{SIK1} | 4.0 V ≤ V _{DD} ≤ 5.5 V, 2.7 V ≤ V _b ≤ 4.0 V, C _b = 20 pF, R _b = 1.4 kΩ | 58 | | | ns |
| | | 2.7 V ≤ V _{DD} < 4.0 V, 2.3 V ≤ V _b ≤ 2.7 V, C _b = 20 pF, R _b = 2.7 kΩ | 121 | | | ns |
| Slp hold time (from SCKp↑) ^{Note 1} | t _{KSH1} | 4.0 V ≤ V _{DD} ≤ 5.5 V, 2.7 V ≤ V _b ≤ 4.0 V, C _b = 20 pF, R _b = 1.4 kΩ | 10 | | | ns |
| | | 2.7 V ≤ V _{DD} < 4.0 V, 2.3 V ≤ V _b ≤ 2.7 V, C _b = 20 pF, R _b = 2.7 kΩ | 10 | | | ns |
| Delay time from SCKp↓ to SOp output ^{Note 1} | t _{KSO1} | 4.0 V ≤ V _{DD} ≤ 5.5 V, 2.7 V ≤ V _b ≤ 4.0 V, C _b = 20 pF, R _b = 1.4 kΩ | | | 60 | ns |
| | | 2.7 V ≤ V _{DD} < 4.0 V, 2.3 V ≤ V _b ≤ 2.7 V, C _b = 20 pF, R _b = 2.7 kΩ | | | 130 | ns |
| Slp setup time (to SCKp↓) ^{Note 2} | t _{SIK1} | 4.0 V ≤ V _{DD} ≤ 5.5 V, 2.7 V ≤ V _b ≤ 4.0 V, C _b = 20 pF, R _b = 1.4 kΩ | 23 | | | ns |
| | | 2.7 V ≤ V _{DD} < 4.0 V, 2.3 V ≤ V _b ≤ 2.7 V, C _b = 20 pF, R _b = 2.7 kΩ | 33 | | | ns |
| Slp hold time (from SCKp↓) ^{Note 2} | t _{KSH1} | 4.0 V ≤ V _{DD} ≤ 5.5 V, 2.7 V ≤ V _b ≤ 4.0 V, C _b = 20 pF, R _b = 1.4 kΩ | 10 | | | ns |
| | | 2.7 V ≤ V _{DD} < 4.0 V, 2.3 V ≤ V _b ≤ 2.7 V, C _b = 20 pF, R _b = 2.7 kΩ | 10 | | | ns |
| Delay time from SCKp↑ to SOp output ^{Note 2} | t _{KSO1} | 4.0 V ≤ V _{DD} ≤ 5.5 V, 2.7 V ≤ V _b ≤ 4.0 V, C _b = 20 pF, R _b = 1.4 kΩ | | | 10 | ns |
| | | 2.7 V ≤ V _{DD} < 4.0 V, 2.3 V ≤ V _b ≤ 2.7 V, C _b = 20 pF, R _b = 2.7 kΩ | | | 10 | ns |

Notes 1. When DAP_mn = 0 and CKP_mn = 0, or DAP_mn = 1 and CKP_mn = 1.2. When DAP_mn = 0 and CKP_mn = 1, or DAP_mn = 1 and CKP_mn = 0.**(Caution and Remark are listed on the next page.)**

Caution Select the TTL input buffer for the SIp pin and the N-ch open drain output (V_{DD} tolerance) mode for the SOp pin and SCKp pin by using port input mode register g (PIMg) and port output mode register g (POMg). For V_{IH} and V_{IL}, see the DC characteristics with TTL input buffer selected.

- Remarks**
1. R_b[Ω]: Communication line (SCKp, SOp) pull-up resistance, C_b[F]: Communication line (SCKp, SOp) load capacitance, V_b[V]: Communication line voltage
 2. p: CSI number (p = 00), m: Unit number (m = 0), n: Channel number (n = 0),
g: PIM and POM number (g = 3, 5)
 3. f_{MCK}: Serial array unit operation clock frequency
(Operation clock to be set by the CKSmn bit of serial mode register mn (SMRmn). m: Unit number,
n: Channel number (mn = 00))
 4. This value is valid only when CSI00's peripheral I/O redirect function is not used.

(8) Communication at different potential (1.8 V, 2.5 V, 3 V) (CSI mode) (master mode, SCKp... internal clock output) (1/2)

(T_A = -40 to +85°C, 2.4 V ≤ V_{DD} ≤ 5.5 V, V_{SS} = 0 V)

| Parameter | Symbol | Conditions | MIN. | TYP. | MAX. | Unit |
|-----------------------|-------------------|--|----------------------------|------|------|------|
| SCKp cycle time | t _{KCY1} | t _{KCY1} ≥ 4/f _{CLK} 4.0 V ≤ V _{DD} ≤ 5.5 V, 2.7 V ≤ V _b ≤ 4.0 V, C _b = 30 pF, R _b = 1.4 kΩ | 300 | | | ns |
| | | 2.7 V ≤ V _{DD} < 4.0 V, 2.3 V ≤ V _b ≤ 2.7 V, C _b = 30 pF, R _b = 2.7 kΩ | 500 | | | ns |
| | | 2.4 V ≤ V _{DD} < 3.3 V, 2.4 V ≤ V _b ≤ 2.0 V, C _b = 30 pF, R _b = 5.5 kΩ | 1150 | | | ns |
| SCKp high-level width | t _{KH1} | 4.0 V ≤ V _{DD} ≤ 5.5 V, 2.7 V ≤ V _b ≤ 4.0 V, C _b = 30 pF, R _b = 1.4 kΩ | t _{KCY1} /2 - 75 | | | ns |
| | | 2.7 V ≤ V _{DD} < 4.0 V, 2.3 V ≤ V _b ≤ 2.7 V, C _b = 30 pF, R _b = 2.7 kΩ | t _{KCY1} /2 - 170 | | | ns |
| | | 2.4 V ≤ V _{DD} < 3.3 V, 1.6 V ≤ V _b ≤ 2.0 V, C _b = 30 pF, R _b = 5.5 kΩ | t _{KCY1} /2 - 458 | | | ns |
| SCKp low-level width | t _{KL1} | 4.0 V ≤ V _{DD} ≤ 5.5 V, 2.7 V ≤ V _b ≤ 4.0 V, C _b = 30 pF, R _b = 1.4 kΩ | t _{KCY1} /2 - 12 | | | ns |
| | | 2.7 V ≤ V _{DD} < 4.0 V, 2.3 V ≤ V _b ≤ 2.7 V, C _b = 30 pF, R _b = 2.7 kΩ | t _{KCY1} /2 - 18 | | | ns |
| | | 2.4 V ≤ V _{DD} < 3.3 V, 1.6 V ≤ V _b ≤ 2.0 V, C _b = 30 pF, R _b = 5.5 kΩ | t _{KCY1} /2 - 50 | | | ns |

Cautions

1. Select the TTL input buffer for the SIp pin and the N-ch open drain output (V_{DD} tolerance) mode for the SOp pin and SCKp pin by using port input mode register g (PIMg) and port output mode register g (POMg). For V_{IH} and V_{IL}, see the DC characteristics with TTL input buffer selected.

2. Use it with V_{DD} ≥ V_b.

(Remarks are listed two pages after the next page.)

(8) Communication at different potential (1.8 V, 2.5 V, 3 V) (CSI mode) (master mode, SCKp... internal clock output)
(2/2)**(T_A = -40 to +85°C, 2.4 V ≤ V_{DD} ≤ 5.5 V, V_{SS} = 0 V)**

| Parameter | Symbol | Conditions | MIN. | TYP. | MAX. | Unit |
|--|-------------------|--|------|------|------|------|
| Slp setup time (to SCKp↑) ^{Note 1} | t _{SIK1} | 4.0 V ≤ V _{DD} ≤ 5.5 V, 2.7 V ≤ V _b ≤ 4.0 V, C _b = 30 pF, R _b = 1.4 kΩ | 81 | | | ns |
| | | 2.7 V ≤ V _{DD} < 4.0 V, 2.3 V ≤ V _b ≤ 2.7 V, C _b = 30 pF, R _b = 2.7 kΩ | 177 | | | ns |
| | | 2.4 V ≤ V _{DD} < 3.3 V, 1.6 V ≤ V _b ≤ 2.0 V ^{Note 3} , C _b = 30 pF, R _b = 5.5 kΩ | 479 | | | ns |
| Slp hold time (from SCKp↑) ^{Note 1} | t _{SI1} | 4.0 V ≤ V _{DD} ≤ 5.5 V, 2.7 V ≤ V _b ≤ 4.0 V, C _b = 30 pF, R _b = 1.4 kΩ | 19 | | | ns |
| | | 2.7 V ≤ V _{DD} < 4.0 V, 2.3 V ≤ V _b ≤ 2.7 V, C _b = 30 pF, R _b = 2.7 kΩ | 19 | | | ns |
| | | 2.4 V ≤ V _{DD} < 3.3 V, 1.6 V ≤ V _b ≤ 2.0 V ^{Note 3} , C _b = 30 pF, R _b = 5.5 kΩ | 19 | | | ns |
| Delay time from SCKp↓ to SOP output ^{Note 1} | t _{KSO1} | 4.0 V ≤ V _{DD} ≤ 5.5 V, 2.7 V ≤ V _b ≤ 4.0 V, C _b = 30 pF, R _b = 1.4 kΩ | | | 100 | ns |
| | | 2.7 V ≤ V _{DD} < 4.0 V, 2.3 V ≤ V _b ≤ 2.7 V, C _b = 30 pF, R _b = 2.7 kΩ | | | 195 | ns |
| | | 2.4 V ≤ V _{DD} < 3.3 V, 1.6 V ≤ V _b ≤ 2.0 V ^{Note 3} , C _b = 30 pF, R _b = 5.5 kΩ | | | 483 | ns |
| Slp setup time (to SCKp↓) ^{Note 2} | t _{SIK1} | 4.0 V ≤ V _{DD} ≤ 5.5 V, 2.7 V ≤ V _b ≤ 4.0 V, C _b = 30 pF, R _b = 1.4 kΩ | 44 | | | ns |
| | | 2.7 V ≤ V _{DD} < 4.0 V, 2.3 V ≤ V _b ≤ 2.7 V, C _b = 30 pF, R _b = 2.7 kΩ | 44 | | | ns |
| | | 2.4 V ≤ V _{DD} < 3.3 V, 1.6 V ≤ V _b ≤ 2.0 V ^{Note 3} , C _b = 30 pF, R _b = 5.5 kΩ | 110 | | | ns |
| Slp hold time (from SCKp↓) ^{Note 2} | t _{SI1} | 4.0 V ≤ V _{DD} ≤ 5.5 V, 2.7 V ≤ V _b ≤ 4.0 V, C _b = 30 pF, R _b = 1.4 kΩ | 19 | | | ns |
| | | 2.7 V ≤ V _{DD} < 4.0 V, 2.3 V ≤ V _b ≤ 2.7 V, C _b = 30 pF, R _b = 2.7 kΩ | 19 | | | ns |
| | | 2.4 V ≤ V _{DD} < 3.3 V, 1.6 V ≤ V _b ≤ 2.0 V ^{Note 3} , C _b = 30 pF, R _b = 5.5 kΩ | 19 | | | ns |
| Delay time from SCKp↑ to SOP output ^{Note 2} | t _{KSO1} | 4.0 V ≤ V _{DD} ≤ 5.5 V, 2.7 V ≤ V _b ≤ 4.0 V, C _b = 30 pF, R _b = 1.4 kΩ | | | 25 | ns |
| | | 2.7 V ≤ V _{DD} < 4.0 V, 2.3 V ≤ V _b ≤ 2.7 V, C _b = 30 pF, R _b = 2.7 kΩ | | | 25 | ns |
| | | 2.4 V ≤ V _{DD} < 3.3 V, 1.6 V ≤ V _b ≤ 2.0 V ^{Note 3} , C _b = 30 pF, R _b = 5.5 kΩ | | | 25 | ns |

(Notes, Cautions and Remarks are listed on the next page.)

- Notes**
1. When $\text{DAPmn} = 0$ and $\text{CKPmn} = 0$, or $\text{DAPmn} = 1$ and $\text{CKPmn} = 1$.
 2. When $\text{DAPmn} = 0$ and $\text{CKPmn} = 1$, or $\text{DAPmn} = 1$ and $\text{CKPmn} = 0$.
 3. Use it with $V_{DD} \geq V_b$.

Caution Select the TTL input buffer for the Slp pin and the N-ch open drain output (V_{DD} tolerance) mode for the SOp pin and SCKp pin by using port input mode register g (PIMg) and port output mode register g (POMg). For V_{IH} and V_{IL} , see the DC characteristics with TTL input buffer selected.

CSI mode connection diagram (during communication at different potential)

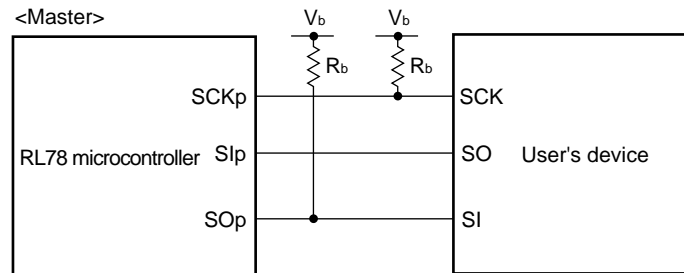

- Remarks**
1. $R_b[\Omega]$: Communication line (SCKp, SOp) pull-up resistance, $C_b[\text{F}]$: Communication line (SCKp, SOp) load capacitance, $V_b[\text{V}]$: Communication line voltage
 2. p: CSI number (p = 00), m: Unit number, n: Channel number (mn = 00), g: PIM and POM number (g = 0, 3, 5, 7)
 3. f_{MCK} : Serial array unit operation clock frequency
(Operation clock to be set by the CKSmn bit of serial mode register mn (SMRmn).
m: Unit number, n: Channel number (mn = 00))
 4. CSI01 cannot communicate at different potential. Use other CSI for communication at different potential.

**CSI mode serial transfer timing (master mode) (during communication at different potential)
(When DAPmn = 0 and CKPmn = 0, or DAPmn = 1 and CKPmn = 1.)**

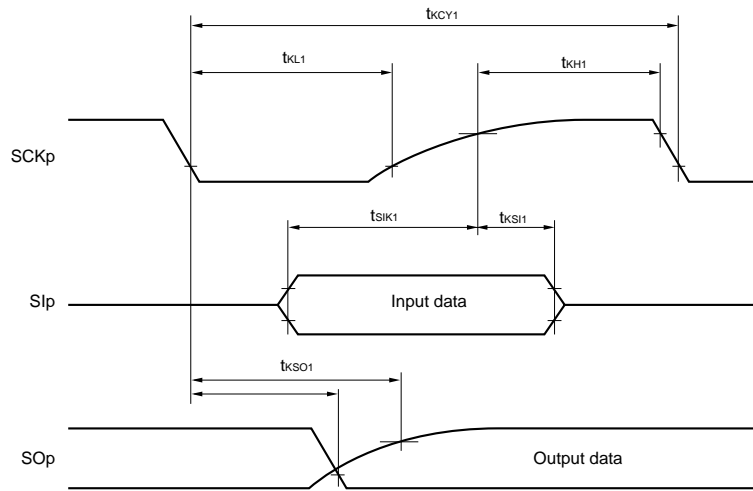

**CSI mode serial transfer timing (master mode) (during communication at different potential)
(When DAPmn = 0 and CKPmn = 1, or DAPmn = 1 and CKPmn = 0.)**

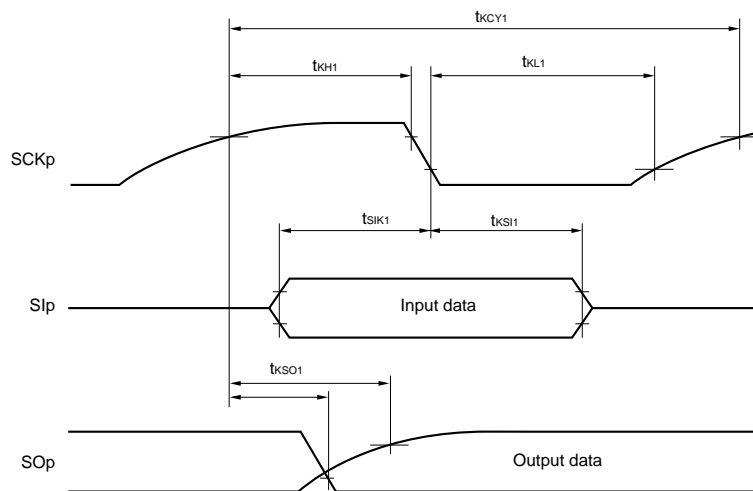

- Remarks**
1. p: CSI number (p = 00), m: Unit number, n: Channel number (mn = 00), g: PIM and POM number (g = 0, 3, 5, 7)
 2. CSI01 cannot communicate at different potential. Use other CSI for communication at different potential.

(9) Communication at different potential (1.8 V, 2.5 V, 3 V) (CSI mode) (slave mode, SCKp... external clock input)**(T_A = -40 to +85°C, 2.4 V ≤ V_{DD} ≤ 5.5 V, V_{SS} = 0 V)**

| Parameter | Symbol | Conditions | MIN. | TYP. | MAX. | Unit |
|---|----------------------------------|--|---|---------------------------|--------------------------|------|
| SCKp cycle time ^{Note 1} | t _{KCY2} | 4.0 V ≤ V _{DD} ≤ 5.5 V, 2.7 V ≤ V _b ≤ 4.0 V | 20 MHz < f _{MCK} ≤ 24 MHz | 12/f _{MCK} | | ns |
| | | | 8 MHz < f _{MCK} ≤ 20 MHz | 10/f _{MCK} | | ns |
| | | | 4 MHz < f _{MCK} ≤ 8 MHz | 8/f _{MCK} | | ns |
| | | | f _{MCK} ≤ 4 MHz | 6/f _{MCK} | | ns |
| | | 2.7 V ≤ V _{DD} < 4.0 V, 2.3 V ≤ V _b ≤ 2.7 V | 20 MHz < f _{MCK} ≤ 24 MHz | 16/f _{MCK} | | ns |
| | | | 16 MHz < f _{MCK} ≤ 20 MHz | 14/f _{MCK} | | ns |
| | | | 8 MHz < f _{MCK} ≤ 16 MHz | 12/f _{MCK} | | ns |
| | | | 4 MHz < f _{MCK} ≤ 8 MHz | 8/f _{MCK} | | ns |
| | | 2.4 V ≤ V _{DD} < 3.3 V, 1.6 V ≤ V _b ≤ 2.0 V ^{Note 2} | f _{MCK} ≤ 4 MHz | 6/f _{MCK} | | ns |
| | | | 20 MHz < f _{MCK} ≤ 24 MHz | 36/f _{MCK} | | ns |
| | | | 16 MHz < f _{MCK} ≤ 20 MHz | 32/f _{MCK} | | ns |
| | | | 8 MHz < f _{MCK} ≤ 16 MHz | 26/f _{MCK} | | ns |
| | 4 MHz < f _{MCK} ≤ 8 MHz | 16/f _{MCK} | | ns | | |
| | f _{MCK} ≤ 4 MHz | 10/f _{MCK} | | ns | | |
| | SCKp high-/low-level width | t _{KH2} , t _{KL2} | 4.0 V ≤ V _{DD} ≤ 5.5 V, 2.7 V ≤ V _b ≤ 4.0 V | t _{KCY2} /2 – 12 | | ns |
| | | | 2.7 V ≤ V _{DD} < 4.0 V, 2.3 V ≤ V _b ≤ 2.7 V | t _{KCY2} /2 – 18 | | ns |
| 2.4 V ≤ V _{DD} < 3.3 V, 1.6 V ≤ V _b ≤ 2.0 V ^{Note 2} | | | t _{KCY2} /2 – 50 | | ns | |
| Slp setup time (to SCKp↑) ^{Note 3} | t _{SIK2} | 4.0 V ≤ V _{DD} ≤ 5.5 V, 2.7 V ≤ V _b ≤ 4.0 V | 1/f _{MCK} + 20 | | ns | |
| | | 2.7 V ≤ V _{DD} < 4.0 V, 2.3 V ≤ V _b ≤ 2.7 V | 1/f _{MCK} + 20 | | ns | |
| | | 2.4 V ≤ V _{DD} < 3.3 V, 1.6 V ≤ V _b ≤ 2.0 V ^{Note 2} | 1/f _{MCK} + 30 | | ns | |
| Slp hold time (from SCKp↑) ^{Note 4} | t _{KS12} | | 1/f _{MCK} + 31 | | ns | |
| Delay time from SCKp↓ to SOp output ^{Note 5} | t _{KSO2} | 4.0 V ≤ V _{DD} ≤ 5.5 V, 2.7 V ≤ V _b ≤ 4.0 V, C _b = 30 pF, R _b = 1.4 kΩ | | | 2/f _{MCK} + 120 | ns |
| | | 2.7 V ≤ V _{DD} < 4.0 V, 2.3 V ≤ V _b ≤ 2.7 V, C _b = 30 pF, R _b = 2.7 kΩ | | | 2/f _{MCK} + 214 | ns |
| | | 2.4 V ≤ V _{DD} < 3.3 V, 1.6 V ≤ V _b ≤ 2.0 V ^{Note 2} , C _b = 30 pF, R _b = 5.5 kΩ | | | 2/f _{MCK} + 573 | ns |

Notes 1. Transfer rate in the SNOOZE mode : MAX. 1 Mbps2. Use it with V_{DD} ≥ V_b.

3. When DAPmn = 0 and CKPmn = 0, or DAPmn = 1 and CKPmn = 1. The Slp setup time becomes “to SCKp↓” when DAPmn = 0 and CKPmn = 1, or DAPmn = 1 and CKPmn = 0.

4. When DAPmn = 0 and CKPmn = 0, or DAPmn = 1 and CKPmn = 1. The Slp hold time becomes “from SCKp↓” when DAPmn = 0 and CKPmn = 1, or DAPmn = 1 and CKPmn = 0.

5. When DAPmn = 0 and CKPmn = 0, or DAPmn = 1 and CKPmn = 1. The delay time to SOp output becomes “from SCKp↑” when DAPmn = 0 and CKPmn = 1, or DAPmn = 1 and CKPmn = 0.

(Caution and Remarks are listed on the next page.)

Caution Select the TTL input buffer for the SIp pin and the N-ch open drain output (V_{DD} tolerance) mode for the SOp pin and SCKp pin by using port input mode register g (PIMg) and port output mode register g (POMg). For V_{IH} and V_{IL} , see the DC characteristics with TTL input buffer selected.

CSI mode connection diagram (during communication at different potential)

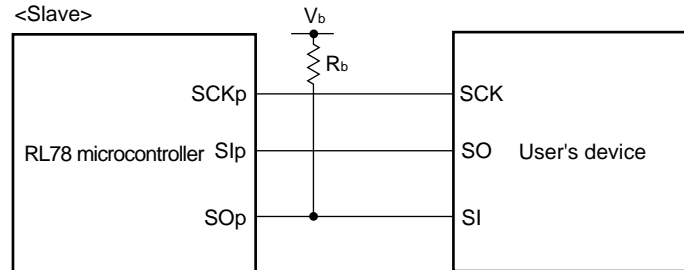

- Remarks**
1. $R_b[\Omega]$: Communication line (SOp) pull-up resistance, $C_b[F]$: Communication line (SOp) load capacitance, $V_b[V]$: Communication line voltage
 2. p: CSI number (p = 00), m: Unit number, n: Channel number (mn = 00), g: PIM and POM number (g = 0, 3, 5, 7)
 3. f_{MCK} : Serial array unit operation clock frequency (Operation clock to be set by the CKSmn bit of serial mode register mn (SMRmn). m: Unit number, n: Channel number (mn = 00))
 4. CSI01 cannot communicate at different potential. Use other CSI for communication at different potential.

CSI mode serial transfer timing (slave mode) (during communication at different potential)
(When DAPmn = 0 and CKPmn = 0, or DAPmn = 1 and CKPmn = 1.)

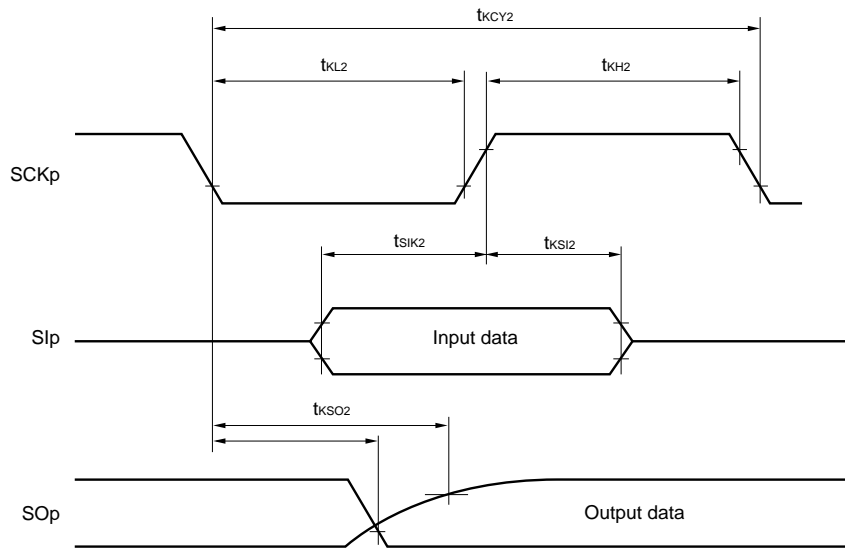

CSI mode serial transfer timing (slave mode) (during communication at different potential)
(When DAPmn = 0 and CKPmn = 1, or DAPmn = 1 and CKPmn = 0.)

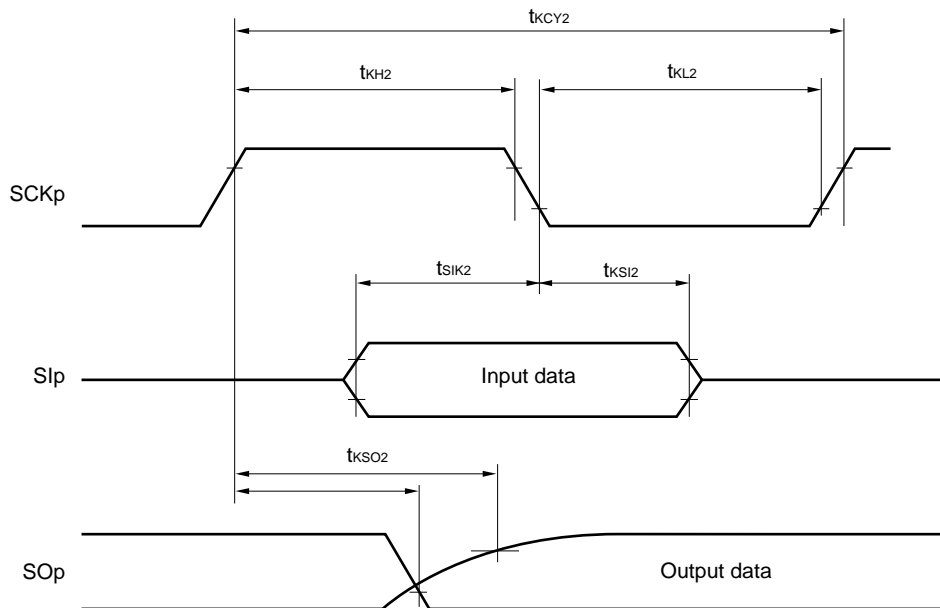

- Remarks 1.** p: CSI number (p = 00), m: Unit number, n: Channel number (mn = 00),
 g: PIM and POM number (g = 0, 3, 5, 7)
- 2.** CSI01 cannot communicate at different potential. Use other CSI for communication at different potential.

(10) Communication at different potential (1.8 V, 2.5 V, 3 V) (simplified I²C mode) (1/2)**(T_A = -40 to +85°C, 2.4 V ≤ V_{DD} ≤ 5.5 V, V_{SS} = 0 V)**

| Parameter | Symbol | Conditions | MIN. | MAX. | Unit |
|---------------------------|-------------------|--|------|------------------------|------|
| SCLr clock frequency | f _{SCL} | 4.0 V ≤ V _{DD} ≤ 5.5 V, 2.7 V ≤ V _b ≤ 4.0 V, C _b = 50 pF, R _b = 2.7 kΩ | | 1000 ^{Note 1} | kHz |
| | | 2.7 V ≤ V _{DD} < 4.0 V, 2.3 V ≤ V _b < 2.7 V, C _b = 50 pF, R _b = 2.7 kΩ | | 1000 ^{Note 1} | kHz |
| | | 4.0 V ≤ V _{DD} ≤ 5.5 V, 2.7 V ≤ V _b ≤ 4.0 V, C _b = 100 pF, R _b = 2.8 kΩ | | 400 ^{Note 1} | kHz |
| | | 2.7 V ≤ V _{DD} < 4.0 V, 2.3 V ≤ V _b < 2.7 V, C _b = 100 pF, R _b = 2.7 kΩ | | 400 ^{Note 1} | kHz |
| | | 2.4 V ≤ V _{DD} < 3.3 V, 1.6 V ≤ V _b ≤ 2.0 V ^{Note 2} , C _b = 100 pF, R _b = 5.5 kΩ | | 300 ^{Note 1} | kHz |
| Hold time when SCLr = "L" | t _{LOW} | 4.0 V ≤ V _{DD} ≤ 5.5 V, 2.7 V ≤ V _b ≤ 4.0 V, C _b = 50 pF, R _b = 2.7 kΩ | 475 | | ns |
| | | 2.7 V ≤ V _{DD} < 4.0 V, 2.3 V ≤ V _b < 2.7 V, C _b = 50 pF, R _b = 2.7 kΩ | 475 | | ns |
| | | 4.0 V ≤ V _{DD} ≤ 5.5 V, 2.7 V ≤ V _b ≤ 4.0 V, C _b = 100 pF, R _b = 2.8 kΩ | 1150 | | ns |
| | | 2.7 V ≤ V _{DD} < 4.0 V, 2.3 V ≤ V _b < 2.7 V, C _b = 100 pF, R _b = 2.7 kΩ | 1150 | | ns |
| | | 2.4 V ≤ V _{DD} < 3.3 V, 1.6 V ≤ V _b ≤ 2.0 V ^{Note 2} , C _b = 100 pF, R _b = 5.5 kΩ | 1550 | | ns |
| Hold time when SCLr = "H" | t _{HIGH} | 4.0 V ≤ V _{DD} ≤ 5.5 V, 2.7 V ≤ V _b ≤ 4.0 V, C _b = 50 pF, R _b = 2.7 kΩ | 245 | | ns |
| | | 2.7 V ≤ V _{DD} < 4.0 V, 2.3 V ≤ V _b < 2.7 V, C _b = 50 pF, R _b = 2.7 kΩ | 200 | | ns |
| | | 4.0 V ≤ V _{DD} ≤ 5.5 V, 2.7 V ≤ V _b ≤ 4.0 V, C _b = 100 pF, R _b = 2.8 kΩ | 675 | | ns |
| | | 2.7 V ≤ V _{DD} < 4.0 V, 2.3 V ≤ V _b < 2.7 V, C _b = 100 pF, R _b = 2.7 kΩ | 600 | | ns |
| | | 2.4 V ≤ V _{DD} < 3.3 V, 1.6 V ≤ V _b ≤ 2.0 V ^{Note 2} , C _b = 100 pF, R _b = 5.5 kΩ | 610 | | ns |

(Notes, Caution and Remarks are listed on the next page.)

(10) Communication at different potential (1.8 V, 2.5 V, 3 V) (simplified I²C mode) (2/2)**(T_A = -40 to +85°C, 2.4 V ≤ V_{DD} ≤ 5.5 V, V_{SS} = 0 V)**

| Parameter | Symbol | Conditions | MIN. | MAX. | Unit |
|-------------------------------|---------------------|--|------------------------------------|------|------|
| Data setup time (reception) | t _{SU:DAT} | 4.0 V ≤ V _{DD} ≤ 5.5 V, 2.7 V ≤ V _b ≤ 4.0 V, C _b = 50 pF, R _b = 2.7 kΩ | 1/f _{MCK} + 135 Note 3 | | ns |
| | | 2.7 V ≤ V _{DD} < 4.0 V, 2.3 V ≤ V _b < 2.7 V, C _b = 50 pF, R _b = 2.7 kΩ | 1/f _{MCK} + 135 Note 3 | | ns |
| | | 4.0 V ≤ V _{DD} ≤ 5.5 V, 2.7 V ≤ V _b ≤ 4.0 V, C _b = 100 pF, R _b = 2.8 kΩ | 1/f _{MCK} + 190 Note 3 | | ns |
| | | 2.7 V ≤ V _{DD} < 4.0 V, 2.3 V ≤ V _b < 2.7 V, C _b = 100 pF, R _b = 2.7 kΩ | 1/f _{MCK} + 190 Note 3 | | ns |
| | | 2.4 V ≤ V _{DD} < 3.3 V, 1.6 V ≤ V _b ≤ 2.0 V ^{Notes 2,} C _b = 100 pF, R _b = 5.5 kΩ | 1/f _{MCK} + 190 Note 3 | | ns |
| Data hold time (transmission) | t _{HD:DAT} | 4.0 V ≤ V _{DD} ≤ 5.5 V, 2.7 V ≤ V _b ≤ 4.0 V, C _b = 50 pF, R _b = 2.7 kΩ | 0 | 305 | ns |
| | | 2.7 V ≤ V _{DD} < 4.0 V, 2.3 V ≤ V _b < 2.7 V, C _b = 50 pF, R _b = 2.7 kΩ | 0 | 305 | ns |
| | | 4.0 V ≤ V _{DD} ≤ 5.5 V, 2.7 V ≤ V _b ≤ 4.0 V, C _b = 100 pF, R _b = 2.8 kΩ | 0 | 355 | ns |
| | | 2.7 V ≤ V _{DD} < 4.0 V, 2.3 V ≤ V _b < 2.7 V, C _b = 100 pF, R _b = 2.7 kΩ | 0 | 355 | ns |
| | | 2.4 V ≤ V _{DD} < 3.3 V, 1.6 V ≤ V _b ≤ 2.0 V ^{Note 2,} C _b = 100 pF, R _b = 5.5 kΩ | 0 | 405 | ns |

Notes 1. The value must also be equal to or less than f_{MCK}/4.**2.** Use it with V_{DD} ≥ V_b.**3.** Set the f_{MCK} value to keep the hold time of SCLr = "L" and SCLr = "H".

Caution Select the TTL input buffer and the N-ch open drain output (V_{DD} tolerance) mode for the SDAr pin and the N-ch open drain output (V_{DD} tolerance) mode for the SCLr pin by using port input mode register g (PIMg) and port output mode register g (POMg). For V_{IH} and V_{IL}, see the DC characteristics with TTL input buffer selected.

(Remarks are listed on the next page.)

Simplified I²C mode connection diagram (during communication at different potential)

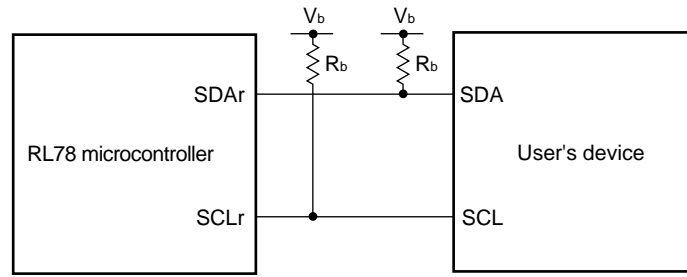

Simplified I²C mode serial transfer timing (during communication at different potential)

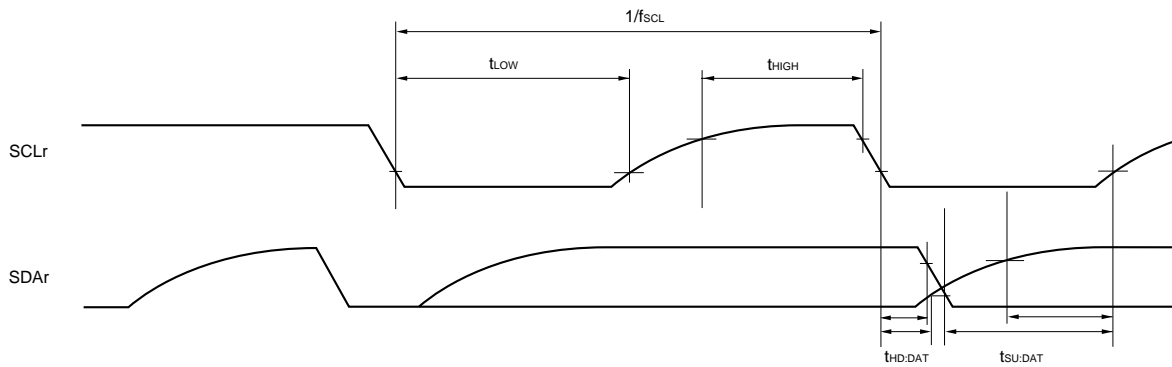

- Remarks**
1. $R_b[\Omega]$: Communication line (SDAr, SCLr) pull-up resistance, $C_b[F]$: Communication line (SDAr, SCLr) load capacitance, $V_b[V]$: Communication line voltage
 2. r: IIC number (r = 00), g: PIM, POM number (g = 0, 3, 5, 7)
 3. f_{MCK} : Serial array unit operation clock frequency
(Operation clock to be set by the CKSmn bit of serial mode register mn (SMRmn). m: Unit number, n: Channel number (mn = 00))

2.5.2 Serial interface IICA

(1) I²C standard mode(T_A = -40 to +85°C, 2.4 V ≤ V_{DD} ≤ 5.5 V, V_{SS} = 0 V)

| Parameter | Symbol | Conditions | HS (high-speed main) mode | | Unit | |
|---|---------------------|---|---------------------------------|------|------|-----|
| | | | MIN. | MAX. | | |
| SCLA0 clock frequency | f _{SCL} | Standard mode: f _{CLK} ≥ 1 MHz | 2.7 V ≤ V _{DD} ≤ 5.5 V | 0 | 100 | kHz |
| | | | 2.4 V ≤ V _{DD} ≤ 5.5 V | 0 | 100 | kHz |
| Setup time of restart condition | t _{SU:STA} | 2.7 V ≤ V _{DD} ≤ 5.5 V | 4.7 | | μs | |
| | | 2.4 V ≤ V _{DD} ≤ 5.5 V | 4.7 | | μs | |
| Hold time ^{Note 1} | t _{HD:STA} | 2.7 V ≤ V _{DD} ≤ 5.5 V | 4.0 | | μs | |
| | | 2.4 V ≤ V _{DD} ≤ 5.5 V | 4.0 | | μs | |
| Hold time when SCLA0 = "L" | t _{LOW} | 2.7 V ≤ V _{DD} ≤ 5.5 V | 4.7 | | μs | |
| | | 2.4 V ≤ V _{DD} ≤ 5.5 V | 4.7 | | μs | |
| Hold time when SCLA0 = "H" | t _{HIGH} | 2.7 V ≤ V _{DD} ≤ 5.5 V | 4.0 | | μs | |
| | | 2.4 V ≤ V _{DD} ≤ 5.5 V | 4.0 | | μs | |
| Data setup time (reception) | t _{SU:DAT} | 2.7 V ≤ V _{DD} ≤ 5.5 V | 250 | | μs | |
| | | 2.4 V ≤ V _{DD} ≤ 5.5 V | 250 | | μs | |
| Data hold time (transmission) ^{Note 2} | t _{HD:DAT} | 2.7 V ≤ V _{DD} ≤ 5.5 V | 0 | 3.45 | μs | |
| | | 2.4 V ≤ V _{DD} ≤ 5.5 V | 0 | 3.45 | μs | |
| Setup time of stop condition | t _{SU:STO} | 2.7 V ≤ V _{DD} ≤ 5.5 V | 4.0 | | μs | |
| | | 2.4 V ≤ V _{DD} ≤ 5.5 V | 4.0 | | μs | |
| Bus-free time | t _{BUF} | 2.7 V ≤ V _{DD} ≤ 5.5 V | 4.7 | | μs | |
| | | 2.4 V ≤ V _{DD} ≤ 5.5 V | 4.7 | | μs | |

- Notes**
1. The first clock pulse is generated after this period when the start/restart condition is detected.
 2. The maximum value (MAX.) of t_{HD:DAT} is during normal transfer and a wait state is inserted in the $\overline{\text{ACK}}$ (acknowledge) timing.

Caution The values in the above table are applied even when bit 1 (PIOR1) in the peripheral I/O redirection register (PIOR) is 1. At this time, the pin characteristics (I_{OH1}, I_{OL1}, V_{OH1}, V_{OL1}) must satisfy the values in the redirect destination.

Remark The maximum value of C_b (communication line capacitance) and the value of R_b (communication line pull-up resistor) at that time in each mode are as follows.

Standard mode: C_b = 400 pF, R_b = 2.7 kΩ

(2) I²C fast mode(T_A = -40 to +85°C, 2.4 V ≤ V_{DD} ≤ 5.5 V, V_{SS} = 0 V)

| Parameter | Symbol | Conditions | | HS (high-speed main) Mode | | Unit |
|---|---------------------|---------------------------------------|---------------------------------|---------------------------|------|------|
| | | | | MIN. | MAX. | |
| SCLA0 clock frequency | f _{SCL} | Fast mode: f _{CLK} ≥ 3.5 MHz | 2.7 V ≤ V _{DD} ≤ 5.5 V | 0 | 400 | kHz |
| | | | 2.4 V ≤ V _{DD} ≤ 5.5 V | 0 | 400 | kHz |
| Setup time of restart condition | t _{SU:STA} | 2.7 V ≤ V _{DD} ≤ 5.5 V | | 0.6 | | μs |
| | | 2.4 V ≤ V _{DD} ≤ 5.5 V | | 0.6 | | μs |
| Hold time ^{Note 1} | t _{HD:STA} | 2.7 V ≤ V _{DD} ≤ 5.5 V | | 0.6 | | μs |
| | | 2.4 V ≤ V _{DD} ≤ 5.5 V | | 0.6 | | μs |
| Hold time when SCLA0 = "L" | t _{LOW} | 2.7 V ≤ V _{DD} ≤ 5.5 V | | 1.3 | | μs |
| | | 2.4 V ≤ V _{DD} ≤ 5.5 V | | 1.3 | | μs |
| Hold time when SCLA0 = "H" | t _{HIGH} | 2.7 V ≤ V _{DD} ≤ 5.5 V | | 0.6 | | μs |
| | | 2.4 V ≤ V _{DD} ≤ 5.5 V | | 0.6 | | μs |
| Data setup time (reception) | t _{SU:DAT} | 2.7 V ≤ V _{DD} ≤ 5.5 V | | 100 | | ns |
| | | 2.4 V ≤ V _{DD} ≤ 5.5 V | | 100 | | ns |
| Data hold time (transmission) ^{Note 2} | t _{HD:DAT} | 2.7 V ≤ V _{DD} ≤ 5.5 V | | 0 | 0.9 | μs |
| | | 2.4 V ≤ V _{DD} ≤ 5.5 V | | 0 | 0.9 | μs |
| Setup time of stop condition | t _{SU:STO} | 2.7 V ≤ V _{DD} ≤ 5.5 V | | 0.6 | | μs |
| | | 2.4 V ≤ V _{DD} ≤ 5.5 V | | 0.6 | | μs |
| Bus-free time | t _{BUF} | 2.7 V ≤ V _{DD} ≤ 5.5 V | | 1.3 | | μs |
| | | 2.4 V ≤ V _{DD} ≤ 5.5 V | | 1.3 | | μs |

Notes 1. The first clock pulse is generated after this period when the start/restart condition is detected.

2. The maximum value (MAX.) of t_{HD:DAT} is during normal transfer and a wait state is inserted in the ACK (acknowledge) timing.

Caution The values in the above table are applied even when bit 1 (PIOR1) in the peripheral I/O redirection register (PIOR) is 1. At this time, the pin characteristics (I_{OH1}, I_{OL1}, V_{OH1}, V_{OL1}) must satisfy the values in the redirect destination.

Remark The maximum value of C_b (communication line capacitance) and the value of R_b (communication line pull-up resistor) at that time in each mode are as follows.

Fast mode: C_b = 320 pF, R_b = 1.1 kΩ

(3) I²C fast mode plus

(T_A = -40 to +85°C, 2.4 V ≤ V_{DD} ≤ 5.5 V, V_{SS} = 0 V)

| Parameter | Symbol | Conditions | | HS (high-speed main) Mode | | Unit |
|---|---------------------|--|---------------------------------|---------------------------|------|------|
| | | | | MIN. | MAX. | |
| SCLA0 clock frequency | f _{SCL} | Fast mode plus: f _{CLK} ≥ 10 MHz | 2.7 V ≤ V _{DD} ≤ 5.5 V | 0 | 1000 | kHz |
| Setup time of restart condition | t _{SU:STA} | 2.7 V ≤ V _{DD} ≤ 5.5 V | | 0.26 | | μs |
| Hold time ^{Note 1} | t _{HD:STA} | 2.7 V ≤ V _{DD} ≤ 5.5 V | | 0.26 | | μs |
| Hold time when SCLA0 = "L" | t _{LOW} | 2.7 V ≤ V _{DD} ≤ 5.5 V | | 0.5 | | μs |
| Hold time when SCLA0 = "H" | t _{HIGH} | 2.7 V ≤ V _{DD} ≤ 5.5 V | | 0.26 | | μs |
| Data setup time (reception) | t _{SU:DAT} | 2.7 V ≤ V _{DD} ≤ 5.5 V | | 50 | | ns |
| Data hold time (transmission) ^{Note 2} | t _{HD:DAT} | 2.7 V ≤ V _{DD} ≤ 5.5 V | | 0 | 0.45 | μs |
| Setup time of stop condition | t _{SU:STO} | 2.7 V ≤ V _{DD} ≤ 5.5 V | | 0.26 | | μs |
| Bus-free time | t _{BUF} | 2.7 V ≤ V _{DD} ≤ 5.5 V | | 0.5 | | μs |

- Notes**
- The first clock pulse is generated after this period when the start/restart condition is detected.
 - The maximum value (MAX.) of t_{HD:DAT} is during normal transfer and a wait state is inserted in the ACK (acknowledge) timing.

Caution The values in the above table are applied even when bit 1 (PIOR1) in the peripheral I/O redirection register (PIOR) is 1. At this time, the pin characteristics (I_{OH1}, I_{OL1}, V_{OH1}, V_{OL1}) must satisfy the values in the redirect destination.

Remark The maximum value of C_b (communication line capacitance) and the value of R_b (communication line pull-up resistor) at that time in each mode are as follows.

Fast mode plus: C_b = 120 pF, R_b = 1.1 kΩ

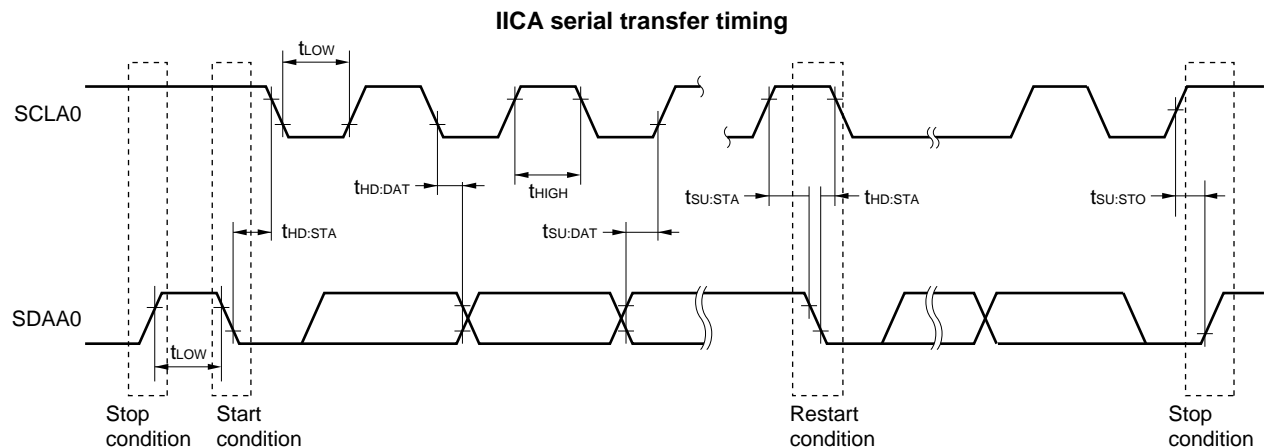

2.5.3 USB

(1) Electrical specifications

(T_A = -40 to +85°C, 3.0 V ≤ UV_{DD} ≤ 3.6 V, 3.0 V ≤ V_{DD} ≤ 5.5 V, V_{SS} = 0 V)

| Parameter | | Symbol | Conditions | MIN. | TYP. | MAX. | Unit |
|-------------------|--|-------------------|---|---------------------------------|------|------|------|
| UV _{DD} | UV _{DD} input voltage characteristic | UV _{DD} | V _{DD} = 3.0 to 5.5 V, PXXCON = 1, VDDUSEB = 0 (UV _{DD} ≤ V _{DD}) | 3.0 | 3.3 | 3.6 | V |
| | UV _{DD} output voltage characteristic | UV _{DD} | V _{DD} = 4.0 to 5.5 V, PXXCON = VDDUSEB = 1 | 3.0 | 3.3 | 3.6 | V |
| UV _{BUS} | UV _{BUS} input voltage characteristic | UV _{BUS} | Function | 4.35 (4.02 ^{Note}) | 5.00 | 5.25 | V |
| | | | Host | 4.75 | 5.00 | 5.25 | V |

Note Value of instantaneous voltage(T_A = -40 to +85°C, 3.0 V ≤ UV_{DD} ≤ 3.6 V, 3.0 V ≤ V_{DD} ≤ 5.5 V, V_{SS} = 0 V)

| Parameter | | Symbol | Conditions | MIN. | TYP. | MAX. | Unit | |
|--|--------------------------------------|---|-----------------------------------|---|------|-------|------|----|
| UDPi/UDMi pins input characteristic (FS/LS receiver) | Input voltage | V _{IH} | | 2.0 | | | V | |
| | | V _{IL} | | | | 0.8 | V | |
| | Difference input sensitivity | V _{DI} | UDP voltage – UDM voltage | 0.2 | | | V | |
| | Difference common mode range | V _{CM} | | 0.8 | | 2.5 | V | |
| UDPi/UDMi pins output characteristic (FS driver) | Output voltage | V _{OH} | I _{OH} = -200 μA | 2.8 | | 3.6 | V | |
| | | V _{OL} | I _{OL} = 2.4 mA | 0 | | 0.3 | V | |
| | Transi-ti on time | Rising | t _{FR} | Rising: From 10% to 90 % of amplitude, | 4 | | 20 | ns |
| | | Falling | t _{FF} | Falling: From 90% to 10 % of amplitude, | 4 | | 20 | ns |
| | Matching (TFR/TFF) | V _{FRFM} | CL = 50 pF | 90 | | 111.1 | % | |
| | Crossover voltage | V _{FCRS} | | 1.3 | | 2.0 | V | |
| Output Impedance | Z _{DRV} | UV _{DD} voltage = 3.3 V, Pin voltage = 1.65 V | 28 | | 44 | Ω | | |
| UDPi/UDMi pins output characteristic (LS driver) | Output voltage | V _{OH} | | 2.8 | | 3.6 | V | |
| | | V _{OL} | | 0 | | 0.3 | V | |
| | Transi-ti on time | Rising | t _{LR} | Rising: From 10% to 90 % of amplitude, | 75 | | 300 | ns |
| | | Falling | t _{LF} | Falling: From 90% to 10 % of amplitude, | 75 | | 300 | ns |
| | Matching (TFR/TFF) Note | V _{LTFM} | CL = 200 to 600 pF | 80 | | 125 | % | |
| Crossover voltage Note | V _{LCRS} | When the host controller function is selected: The UDMi pin (i = 0, 1) is pulled up via 1.5 kΩ. When the function controller function is selected: The UDP0 and UDM0 pins are individually pulled down via 15 kΩ | 1.3 | | 2.0 | V | | |
| UDPi/UDMi pins pull-up, pull-down | Pull-down resistor | R _{PD} | | 14.25 | | 24.80 | kΩ | |
| | Pull-up resistor (i = 0 only) | Idle | R _{PUI} | 0.9 | | 1.575 | kΩ | |
| | | Reception | R _{PUA} | 1.425 | | 3.09 | kΩ | |
| UV _{BUS} | UV _{BUS} pull-down resistor | R _{VBUS} | UV _{BUS} voltage = 5.5 V | | 1000 | | kΩ | |
| | UV _{BUS} input voltage | V _{IH} | | 3.20 | | | V | |
| | | V _{IL} | | | | 0.8 | V | |

Note Excludes the first signal transition from the idle state.**Remark** i = 0, 1

Timing of UDPi and UDMi

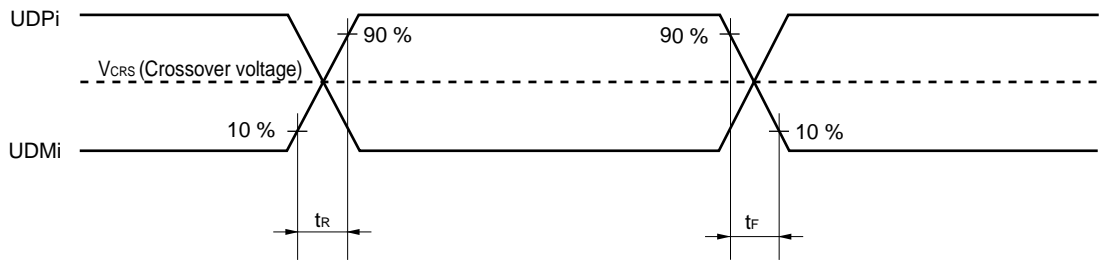

(2) BC standard

($T_A = -40$ to $+85^\circ\text{C}$, $3.0\text{ V} \leq UV_{DD} \leq 3.6\text{ V}$, $3.0\text{ V} \leq V_{DD} \leq 5.5\text{ V}$, $V_{SS} = 0\text{ V}$)

| | Parameter | Symbol | Conditions | MIN. | TYP. | MAX. | Unit |
|--------------------|----------------------------------|----------------|--|------|------|------|---------------|
| USB standard BC1.2 | UDPi sink current | I_{DP_SINK} | | 25 | | 175 | μA |
| | UDMi sink current | I_{DM_SINK} | | 25 | | 175 | μA |
| | DCD source current | I_{DP_SRC} | | 7 | | 13 | μA |
| | Dedicated charging port resistor | R_{DCP_DAT} | $0\text{ V} < \text{UDP/UDM voltage} < 1.0\text{ V}$ | | | 200 | Ω |
| | Data detection voltage | V_{DAT_REF} | | 0.25 | | 0.4 | V |
| | UDPi source voltage | V_{DP_SRC} | Output current $250\ \mu\text{A}$ | 0.5 | | 0.7 | V |
| | UDMi source voltage | V_{DM_SRC} | Output current $250\ \mu\text{A}$ | 0.5 | | 0.7 | V |

Remark $i = 0, 1$

(3) BC option standard (Host)

(T_A = -40 to +85°C, 4.75 V ≤ UV_{BUS} ≤ 5.25 V, 3.0 V ≤ UV_{DD} ≤ 3.6 V, 2.4 V ≤ V_{DD} ≤ 5.5 V, V_{SS} = 0 V)

| Parameter | | Symbol | Conditions | MIN. | TYP. | MAX. | Unit | |
|---|-------------------------|------------------------|--|---|------|-------|------|---------------------|
| UDPi output voltage (UV _{BUS} divider ratio) • VDOUEi = 1 | VDSELi [3:0] (i = 0, 1) | 1000 | V _{P20} | | 38 | 40 | 42 | % UV _{BUS} |
| | | 1001 | V _{P27} | | 51.6 | 53.6 | 55.6 | % UV _{BUS} |
| | | 1010 | V _{P20} | | 38 | 40 | 42 | % UV _{BUS} |
| | | 1100 | V _{P33} | | 60 | 66 | 72 | % UV _{BUS} |
| UDMi output voltage (UV _{BUS} divider ratio) • VDOUEi = 1 | VDSELi [3:0] (i = 0, 1) | 1000 | V _{M20} | | 38 | 40 | 42 | % UV _{BUS} |
| | | 1001 | V _{M20} | | 38 | 40 | 42 | % UV _{BUS} |
| | | 1010 | V _{M27} | | 51.6 | 53.6 | 55.6 | % UV _{BUS} |
| | | 1100 | V _{M33} | | 60 | 66 | 72 | % UV _{BUS} |
| UDPi comparing voltage Note 1 (UV _{BUS} divider ratio) • VDOUEi = 1 • CUSDETEi = 1 | VDSELi [3:0] (i = 0, 1) | 1000 | V _{HDETP_UP0} | The rise of pin voltage detection voltage | 56.2 | | | % UV _{BUS} |
| | | | V _{HDETP_DWN0} | The fall of pin voltage detection voltage | | | 29.4 | % UV _{BUS} |
| | | 1001 | V _{HDETP_UP1} | The rise of pin voltage detection voltage | 60.5 | | | % UV _{BUS} |
| | | | V _{HDETP_DWN1} | The fall of pin voltage detection voltage | | | 45.0 | % UV _{BUS} |
| | | 1010 | V _{HDETP_UP2} | The rise of pin voltage detection voltage | 56.2 | | | % UV _{BUS} |
| | | | V _{HDETP_DWN2} | The fall of pin voltage detection voltage | | | 29.4 | % UV _{BUS} |
| UDMi comparing voltage Note 1 (UV _{BUS} divider ratio) • VDOUEi = 1 • CUSDETEi = 1 | VDSELi [3:0] (i = 0, 1) | 1000 | V _{HDETM_UP0} | The rise of pin voltage detection voltage | 56.2 | | | % UV _{BUS} |
| | | | V _{HDETM_DWN0} | The fall of pin voltage detection voltage | | | 29.4 | % UV _{BUS} |
| | | 1001 | V _{HDETM_UP1} | The rise of pin voltage detection voltage | 56.2 | | | % UV _{BUS} |
| | | | V _{HDETM_DWN1} | The fall of pin voltage detection voltage | | | 29.4 | % UV _{BUS} |
| | | 1010 | V _{HDETM_UP2} | The rise of pin voltage detection voltage | 60.5 | | | % UV _{BUS} |
| | | | V _{HDETM_DWN2} | The fall of pin voltage detection voltage | | | 45.0 | % UV _{BUS} |
| UDPi pull-up detection Note 2 Connect detection with the full speed function (pull-up resistor) | 1000 | R _{HDET_PULL} | In full-speed mode, the power supply voltage range of pull-up resistors connected to the USB function module is between 3.0 V and 3.6 V. | | | 1.575 | kΩ | |
| | | | | | | | | 1001 |
| | | | | | | | | 1010 |
| UDMi pull-up detection Note 2 Connect detection with the low-speed (pull-up resistor) | 1000 | R _{HDET_PULL} | In low-speed mode, the power supply voltage range of pull-up resistors connected to the USB function module is between 3.0 V and 3.6 V. | | | 1.575 | kΩ | |
| | | | | | | | | 1001 |
| | | | | | | | | 1010 |
| UDMi sink current detection Note 2 Connect detection with the BC1.2 portable device (sink resistor) | 1000 | I _{HDET_SINK} | | 25 | | | μA | |
| | | | | | | | | 1001 |
| | | | | | | | | 1010 |

Notes 1. If the voltage output from UDPi or UDMi (i = 0, 1) exceeds the range of the MAX and MIN values prescribed in this specification, DPCUSDETi (bit 8) and DMCUSDETi (bit 9) of the USBBCOPTi register are set to 1.

2. If the pull-up resistance or sink current prescribed in this specification is applied to UDPi or UDMi (i = 0, 1), DPCUSDETi (bit 8) and DMCUSDETi (bit 9) of the USBBCOPTi register are set to 1.

Remark i = 0, 1

(4) BC option standard (Function)

(T_A = -40 to +85°C, 4.35 V ≤ UV_{BUS} ≤ 5.25 V, 3.0 V ≤ UV_{DD} ≤ 3.6 V, 2.4 V ≤ V_{DD} ≤ 5.5 V, V_{SS} = 0 V)

| Parameter | | Symbol | Conditions | MIN. | TYP. | MAX. | Unit | |
|--|----------------------------|--------|---------------------|------|------|------|------|---------------------|
| UDPi/UDMi input reference voltage (UV _{BUS} divider ratio) • VDOUE _i = 0 (i = 0)) | VDSELi [3:0] (i = 0) | 0000 | V _{DDET0} | | 27 | 32 | 37 | % UV _{BUS} |
| | | 0001 | V _{DDET1} | | 29 | 34 | 39 | % UV _{BUS} |
| | | 0010 | V _{DDET2} | | 32 | 37 | 42 | % UV _{BUS} |
| | | 0011 | V _{DDET3} | | 35 | 40 | 45 | % UV _{BUS} |
| | | 0100 | V _{DDET4} | | 38 | 43 | 48 | % UV _{BUS} |
| | | 0101 | V _{DDET5} | | 41 | 46 | 51 | % UV _{BUS} |
| | | 0110 | V _{DDET6} | | 44 | 49 | 54 | % UV _{BUS} |
| | | 0111 | V _{DDET7} | | 47 | 52 | 57 | % UV _{BUS} |
| | | 1000 | V _{DDET8} | | 51 | 56 | 61 | % UV _{BUS} |
| | | 1001 | V _{DDET9} | | 55 | 60 | 65 | % UV _{BUS} |
| | | 1010 | V _{DDET10} | | 59 | 64 | 69 | % UV _{BUS} |
| | | 1011 | V _{DDET11} | | 63 | 68 | 73 | % UV _{BUS} |
| | | 1100 | V _{DDET12} | | 67 | 72 | 77 | % UV _{BUS} |
| | | 1101 | V _{DDET13} | | 71 | 76 | 81 | % UV _{BUS} |
| | | 1110 | V _{DDET14} | | 75 | 80 | 85 | % UV _{BUS} |
| | | 1111 | V _{DDET15} | | 79 | 84 | 89 | % UV _{BUS} |

2.6 Analog Characteristics

2.6.1 A/D converter characteristics

Classification of A/D converter characteristics

| Input channel | Reference Voltage | | |
|---|--|--|--|
| | Reference voltage (+) = AV _{REFP} Reference voltage (-) = AV _{REFM} | Reference voltage (+) = V _{DD} Reference voltage (-) = V _{SS} | Reference voltage (+) = V _{BGR} Reference voltage (-) = AV _{REFM} |
| ANI0 to ANI7 | Refer to 2.6.1 (1). | Refer to 2.6.1 (3). | Refer to 2.6.1 (4). |
| ANI16, ANI17, ANI19 | Refer to 2.6.1 (2). | | |
| Internal reference voltage Temperature sensor output voltage | Refer to 2.6.1 (1). | | – |

(1) When AV_{REF(+)} = AV_{REFP}/ANI0 (ADREFP1 = 0, ADREFP0 = 1), reference voltage (-) = AV_{REFM}/ANI1 (ADREFM = 1), target pin : ANI2 to ANI7, internal reference voltage, and temperature sensor output voltage

(T_A = -40 to +85°C, 2.4 V ≤ AV_{REFP} ≤ V_{DD} ≤ 5.5 V, V_{SS} = 0 V, Reference voltage (+) = AV_{REFP}, Reference voltage (-) = AV_{REFM} = 0 V)

| Parameter | Symbol | Conditions | | MIN. | TYP. | MAX. | Unit |
|--|-------------------|--|---------------------------------|---------------------------------------|------|--------------------|------|
| Resolution | R _{ES} | | | 8 | | 10 | bit |
| Overall error ^{Note 1} | AINL | 10-bit resolution AV _{REFP} = V _{DD} ^{Note 3} | 2.4 V ≤ V _{DD} ≤ 5.5 V | | 1.2 | ±3.5 | LSB |
| Conversion time | t _{CONV} | 10-bit resolution Target pin: ANI2 to ANI7 | 3.6 V ≤ V _{DD} ≤ 5.5 V | 2.125 | | 39 | μs |
| | | | 2.7 V ≤ V _{DD} ≤ 5.5 V | 3.1875 | | 39 | μs |
| | | | 2.4 V ≤ V _{DD} ≤ 5.5 V | 17 | | 39 | μs |
| | | 10-bit resolution Target pin: Internal reference voltage, and temperature sensor output voltage (HS (high-speed main) mode) | 3.6 V ≤ V _{DD} ≤ 5.5 V | 2.375 | | 39 | μs |
| | | | 2.7 V ≤ V _{DD} ≤ 5.5 V | 3.5625 | | 39 | μs |
| | | | 2.4 V ≤ V _{DD} ≤ 5.5 V | 17 | | 39 | μs |
| Zero-scale error ^{Notes 1, 2} | EZS | 10-bit resolution AV _{REFP} = V _{DD} ^{Note 3} | 2.4 V ≤ V _{DD} ≤ 5.5 V | | | ±0.25 | %FSR |
| Full-scale error ^{Notes 1, 2} | EFS | 10-bit resolution AV _{REFP} = V _{DD} ^{Note 3} | 2.4 V ≤ V _{DD} ≤ 5.5 V | | | ±0.25 | %FSR |
| Integral linearity error ^{Note 1} | ILE | 10-bit resolution AV _{REFP} = V _{DD} ^{Note 3} | 2.4 V ≤ V _{DD} ≤ 5.5 V | | | ±2.5 | LSB |
| Differential linearity error ^{Note 1} | DLE | 10-bit resolution AV _{REFP} = V _{DD} ^{Note 3} | 2.4 V ≤ V _{DD} ≤ 5.5 V | | | ±1.5 | LSB |
| Analog input voltage | V _{AIN} | ANI2 to ANI7 | | 0 | | AV _{REFP} | V |
| | | Internal reference voltage (2.4 V ≤ V _{DD} ≤ 5.5 V, HS (high-speed main) mode) | | V _{BGR} ^{Note 4} | | | V |
| | | Temperature sensor output voltage (2.4 V ≤ V _{DD} ≤ 5.5 V, HS (high-speed main) mode) | | V _{TMPS25} ^{Note 4} | | | V |

(Notes are listed on the next page.)

- Notes**
1. Excludes quantization error ($\pm 1/2$ LSB).
 2. This value is indicated as a ratio (%FSR) to the full-scale value.
 3. When $AV_{REFP} < V_{DD}$, the MAX. values are as follows.
Overall error: Add ± 1.0 LSB to the MAX. value when $AV_{REFP} = V_{DD}$.
Zero-scale error/Full-scale error: Add $\pm 0.05\%$ FSR to the MAX. value when $AV_{REFP} = V_{DD}$.
Integral linearity error/ Differential linearity error: Add ± 0.5 LSB to the MAX. value when $AV_{REFP} = V_{DD}$.
 4. Refer to **2.6.2 Temperature sensor/internal reference voltage characteristics**.

(2) When reference voltage (+) = $AV_{REFP}/ANI0$ (ADREFP1 = 0, ADREFP0 = 1), reference voltage (-) = $AV_{REFM}/ANI1$ (ADREFM = 1), target pin : ANI16, ANI17, ANI19

(T_A = -40 to +85°C, 2.4 V ≤ AV_{REFP} ≤ V_{DD} ≤ 5.5 V, V_{SS} = 0 V, Reference voltage (+) = AV_{REFP}, Reference voltage (-) = AV_{REFM} = 0 V)

| Parameter | Symbol | Conditions | MIN. | TYP. | MAX. | Unit | |
|--|-------------------|---|---------------------------------|--------|---|---------------|----|
| Resolution | R _{ES} | | 8 | | 10 | bit | |
| Overall error ^{Note 1} | AINL | 10-bit resolution AV _{REFP} = V _{DD} ^{Note 3} | 2.4 V ≤ V _{DD} ≤ 5.5 V | | 1.2 | ±5.0 LSB | |
| Conversion time | t _{CONV} | 10-bit resolution Target ANI pin : ANI16, ANI17, ANI19 | 3.6 V ≤ V _{DD} ≤ 5.5 V | 2.125 | | 39 | μs |
| | | | 2.7 V ≤ V _{DD} ≤ 5.5 V | 3.1875 | | 39 | μs |
| | | | 2.4 V ≤ V _{DD} ≤ 5.5 V | 17 | | 39 | μs |
| Zero-scale error ^{Notes 1, 2} | EZS | 10-bit resolution AV _{REFP} = V _{DD} ^{Note 3} | 2.4 V ≤ V _{DD} ≤ 5.5 V | | | ±0.35 %FSR | |
| Full-scale error ^{Notes 1, 2} | EFS | 10-bit resolution AV _{REFP} = V _{DD} ^{Note 3} | 2.4 V ≤ V _{DD} ≤ 5.5 V | | | ±0.35 %FSR | |
| Integral linearity error ^{Note 1} | ILE | 10-bit resolution AV _{REFP} = V _{DD} ^{Note 3} | 2.4 V ≤ V _{DD} ≤ 5.5 V | | | ±3.5 LSB | |
| Differential linearity error ^{Note 1} | DLE | 10-bit resolution AV _{REFP} = V _{DD} ^{Note 3} | 2.4 V ≤ V _{DD} ≤ 5.5 V | | | ±2.00 LSB | |
| Analog input voltage | V _{AIN} | ANI16, ANI17, ANI19 | 0 | | AV _{REFP} and V _{DD} | V | |

Notes 1. Excludes quantization error (±1/2 LSB).

2. This value is indicated as a ratio (%FSR) to the full-scale value.

3. When AV_{REFP} < V_{DD}, the MAX. values are as follows.

Overall error: Add ±4.0 LSB to the MAX. value when AV_{REFP} = V_{DD}.

Zero-scale error/Full-scale error: Add ±0.20%FSR to the MAX. value when AV_{REFP} = V_{DD}.

Integral linearity error/ Differential linearity error: Add ±2.0 LSB to the MAX. value when AV_{REFP} = V_{DD}.

(3) Reference voltage (+) = V_{DD} (ADREFF1 = 0, ADREFF0 = 0), Reference voltage (-) = V_{SS} (ADREFM = 0), target ANI pin : ANI0 to ANI7, ANI16, ANI17, ANI19, internal reference voltage, and temperature sensor output voltage

(T_A = -40 to +85°C, 2.4 V ≤ V_{DD} ≤ 5.5 V, V_{SS} = 0 V, Reference voltage (+) = V_{DD}, Reference voltage (-) = V_{SS})

| Parameter | Symbol | Conditions | | MIN. | TYP. | MAX. | Unit |
|--|-------------------|---|---------------------------------|---------------------------------------|------|-----------------|------|
| Resolution | R _{ES} | | | 8 | | 10 | bit |
| Overall error ^{Notes 1, 2} | AINL | 10-bit resolution | 2.4 V ≤ V _{DD} ≤ 5.5 V | | 1.2 | ±7.0 | LSB |
| Conversion time | t _{CONV} | 10-bit resolution Target ANI pin : ANI0 to ANI7, ANI16, ANI17, ANI19 | 3.6 V ≤ V _{DD} ≤ 5.5 V | 2.125 | | 39 | μs |
| | | | 2.7 V ≤ V _{DD} ≤ 5.5 V | 3.1875 | | 39 | μs |
| | | | 2.4 V ≤ V _{DD} ≤ 5.5 V | 17 | | 39 | μs |
| | | 10-bit resolution Target ANI pin : Internal reference voltage, and temperature sensor output voltage (HS (high-speed main) mode) | 3.6 V ≤ V _{DD} ≤ 5.5 V | 2.375 | | 39 | μs |
| | | | 2.7 V ≤ V _{DD} ≤ 5.5 V | 3.5625 | | 39 | μs |
| | | | 2.4 V ≤ V _{DD} ≤ 5.5 V | 17 | | 39 | μs |
| Zero-scale error ^{Notes 1, 2} | EZS | 10-bit resolution | 2.4 V ≤ V _{DD} ≤ 5.5 V | | | ±0.60 | %FSR |
| Full-scale error ^{Notes 1, 2} | EFS | 10-bit resolution | 2.4 V ≤ V _{DD} ≤ 5.5 V | | | ±0.60 | %FSR |
| Integral linearity error ^{Note 1} | ILE | 10-bit resolution | 2.4 V ≤ V _{DD} ≤ 5.5 V | | | ±4.0 | LSB |
| Differential linearity error ^{Note 1} | DLE | 10-bit resolution | 2.4 V ≤ V _{DD} ≤ 5.5 V | | | ±2.0 | LSB |
| Analog input voltage | V _{AIN} | ANI0 to ANI7, ANI16, ANI17, ANI19 | | 0 | | V _{DD} | V |
| | | Internal reference voltage (2.4 V ≤ V _{DD} ≤ 5.5 V, HS (high-speed main) mode) | | V _{BGR} ^{Note 3} | | | V |
| | | Temperature sensor output voltage (2.4 V ≤ V _{DD} ≤ 5.5 V, HS (high-speed main) mode) | | V _{TMPS25} ^{Note 3} | | | V |

Notes 1. Excludes quantization error (±1/2 LSB).

2. This value is indicated as a ratio (%FSR) to the full-scale value.

3. Refer to 2.6.2 Temperature sensor/internal reference voltage characteristics.

(4) When Reference voltage (+) = Internal reference voltage (ADREFP1 = 1, ADREFP0 = 0), Reference voltage (-) = AV_{REFM}/ANI1 (ADREFM = 1), target pin : ANI0 to ANI7, ANI16, ANI17, ANI19

(T_A = -40 to +85°C, 2.4 V ≤ V_{DD} ≤ 5.5 V, V_{SS} = 0 V, Reference voltage (+) = V_{BGR}^{Note 3}, Reference voltage (-) = AV_{REFM}^{Note 4} = 0 V, HS (high-speed main) mode)

| Parameter | Symbol | Conditions | | MIN. | TYP. | MAX. | Unit |
|--|-------------------|------------------|---------------------------------|------|------|------------------------------------|------|
| Resolution | R _{ES} | | | 8 | | | Bit |
| Conversion time | t _{CONV} | 8-bit resolution | 2.4 V ≤ V _{DD} ≤ 5.5 V | 17 | | 39 | μs |
| Zero-scale error ^{Notes 1, 2} | EZS | 8-bit resolution | 2.4 V ≤ V _{DD} ≤ 5.5 V | | | ±0.60 | %FSR |
| Integral linearity error ^{Note 1} | ILE | 8-bit resolution | 2.4 V ≤ V _{DD} ≤ 5.5 V | | | ±2.0 | LSB |
| Differential linearity error ^{Note 1} | DLE | 8-bit resolution | 2.4 V ≤ V _{DD} ≤ 5.5 V | | | ±1.0 | LSB |
| Analog input voltage | V _{AIN} | | | 0 | | V _{BGR} ^{Note 3} | V |

Notes 1. Excludes quantization error (±1/2 LSB).

2. This value is indicated as a ratio (%FSR) to the full-scale value.

3. Refer to **2.6.2 Temperature sensor/internal reference voltage characteristics**.

4. When reference voltage (-) = V_{SS}, the MAX. values are as follows.

Zero-scale error: Add ±0.35%FSR to the MAX. value when reference voltage (-) = AV_{REFM}.

Integral linearity error: Add ±0.5 LSB to the MAX. value when reference voltage (-) = AV_{REFM}.

Differential linearity error: Add ±0.2 LSB to the MAX. value when reference voltage (-) = AV_{REFM}.

2.6.2 Temperature sensor/internal reference voltage characteristics

($T_A = -40$ to $+85^\circ\text{C}$, $2.4\text{ V} \leq V_{DD} \leq 5.5\text{ V}$, $V_{SS} = 0\text{ V}$, HS (high-speed main) mode)

| Parameter | Symbol | Conditions | MIN. | TYP. | MAX. | Unit |
|-----------------------------------|-------------|---|------|------|------|----------------------------|
| Temperature sensor output voltage | V_{TMS25} | Setting ADS register = 80H, $T_A = +25^\circ\text{C}$ | | 1.05 | | V |
| Internal reference voltage | V_{BGR} | Setting ADS register = 81H | 1.38 | 1.45 | 1.5 | V |
| Temperature coefficient | F_{VTMS} | Temperature sensor that depends on the temperature | | -3.6 | | $\text{mV}/^\circ\text{C}$ |
| Operation stabilization wait time | t_{AMP} | | 5 | | | μs |

2.6.3 POR circuit characteristics

($T_A = -40$ to $+85^\circ\text{C}$, $V_{SS} = 0\text{ V}$)

| Parameter | Symbol | Conditions | MIN. | TYP. | MAX. | Unit |
|-------------------------------------|-----------|------------------------|------|------|------|---------------|
| Detection voltage | V_{POR} | Power supply rise time | 1.47 | 1.51 | 1.55 | V |
| | V_{PDR} | Power supply fall time | 1.46 | 1.50 | 1.54 | V |
| Minimum pulse width ^{Note} | T_{PW} | | 300 | | | μs |

Note Minimum time required for a POR reset when V_{DD} exceeds below V_{PDR} . This is also the minimum time required for a POR reset from when V_{DD} exceeds below 0.7 V to when V_{DD} exceeds V_{POR} while STOP mode is entered or the main system clock (f_{MAIN}) is stopped through setting bit 0 (HIOSTOP) and bit 7 (MSTOP) in the clock operation status control register (CSC).

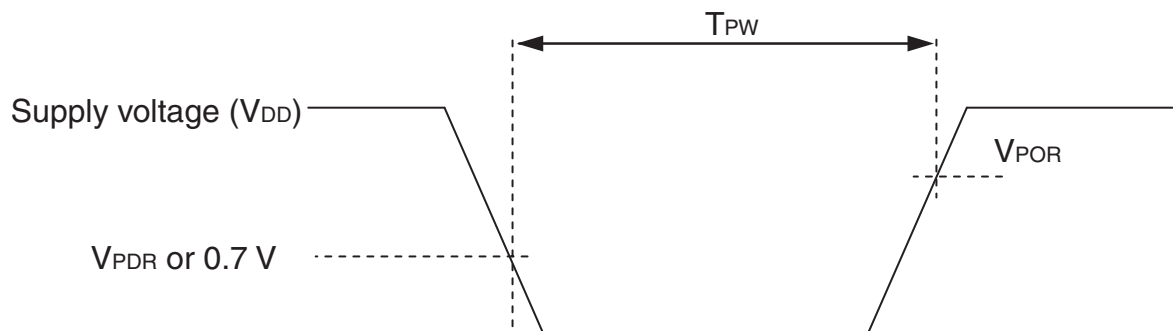

2.6.4 LVD circuit characteristics

LVD Detection Voltage of Reset Mode and Interrupt Mode(T_A = -40 to +85°C, V_{PDR} ≤ V_{DD} ≤ 5.5 V, V_{SS} = 0 V)

| Parameter | | Symbol | Conditions | MIN. | TYP. | MAX. | Unit |
|----------------------|----------------------|-------------------|------------------------|------|------|------|------|
| Detection voltage | Supply voltage level | V _{LVD0} | Power supply rise time | 3.98 | 4.06 | 4.14 | V |
| | | | Power supply fall time | 3.90 | 3.98 | 4.06 | V |
| | | V _{LVD1} | Power supply rise time | 3.68 | 3.75 | 3.82 | V |
| | | | Power supply fall time | 3.60 | 3.67 | 3.74 | V |
| | | V _{LVD2} | Power supply rise time | 3.07 | 3.13 | 3.19 | V |
| | | | Power supply fall time | 3.00 | 3.06 | 3.12 | V |
| | | V _{LVD3} | Power supply rise time | 2.96 | 3.02 | 3.08 | V |
| | | | Power supply fall time | 2.90 | 2.96 | 3.02 | V |
| | | V _{LVD4} | Power supply rise time | 2.86 | 2.92 | 2.97 | V |
| | | | Power supply fall time | 2.80 | 2.86 | 2.91 | V |
| | | V _{LVD5} | Power supply rise time | 2.76 | 2.81 | 2.87 | V |
| | | | Power supply fall time | 2.70 | 2.75 | 2.81 | V |
| | | V _{LVD6} | Power supply rise time | 2.66 | 2.71 | 2.76 | V |
| | | | Power supply fall time | 2.60 | 2.65 | 2.70 | V |
| | | V _{LVD7} | Power supply rise time | 2.56 | 2.61 | 2.66 | V |
| | | | Power supply fall time | 2.50 | 2.55 | 2.60 | V |
| | | V _{LVD8} | Power supply rise time | 2.45 | 2.50 | 2.55 | V |
| | | | Power supply fall time | 2.40 | 2.45 | 2.50 | V |
| Minimum pulse width | | t _{LW} | | 300 | | | μs |
| Detection delay time | | t _{LD} | | | | 300 | μs |

LVD Detection Voltage of Interrupt & Reset Mode**($T_A = -40$ to $+85^\circ\text{C}$, $V_{PDR} \leq V_{DD} \leq 5.5$ V, $V_{SS} = 0$ V)**

| Parameter | Symbol | Conditions | MIN. | TYP. | MAX. | Unit | |
|--------------------------|-------------|--|------------------------------|------|------|------|---|
| Interrupt and reset mode | V_{LVDC0} | VPOC2, VPOC1, VPOC0 = 0, 1, 0, falling reset voltage | 2.40 | 2.45 | 2.50 | V | |
| | V_{LVDC1} | LVIS1, LVIS0 = 1, 0 | Rising release reset voltage | 2.56 | 2.61 | 2.66 | V |
| | | | Falling interrupt voltage | 2.50 | 2.55 | 2.60 | V |
| | V_{LVDC2} | LVIS1, LVIS0 = 0, 1 | Rising release reset voltage | 2.66 | 2.71 | 2.76 | V |
| | | | Falling interrupt voltage | 2.60 | 2.65 | 2.70 | V |
| | V_{LVDC3} | LVIS1, LVIS0 = 0, 0 | Rising release reset voltage | 3.68 | 3.75 | 3.82 | V |
| | | | Falling interrupt voltage | 3.60 | 3.67 | 3.74 | V |
| | V_{LVDD0} | VPOC2, VPOC1, VPOC0 = 0, 1, 1, falling reset voltage | 2.70 | 2.75 | 2.81 | V | |
| | V_{LVDD1} | LVIS1, LVIS0 = 1, 0 | Rising release reset voltage | 2.86 | 2.92 | 2.97 | V |
| | | | Falling interrupt voltage | 2.80 | 2.86 | 2.91 | V |
| | V_{LVDD2} | LVIS1, LVIS0 = 0, 1 | Rising release reset voltage | 2.96 | 3.02 | 3.08 | V |
| | | | Falling interrupt voltage | 2.90 | 2.96 | 3.02 | V |
| | V_{LVDD3} | LVIS1, LVIS0 = 0, 0 | Rising release reset voltage | 3.98 | 4.06 | 4.14 | V |
| | | | Falling interrupt voltage | 3.90 | 3.98 | 4.06 | V |

2.6.5 Power supply voltage rising slope characteristics

($T_A = -40$ to $+85^\circ\text{C}$, $V_{SS} = 0$ V)

| Parameter | Symbol | Conditions | MIN. | TYP. | MAX. | Unit |
|-----------------------------------|-----------|------------|------|------|------|------|
| Power supply voltage rising slope | S_{VDD} | | | | 54 | V/ms |

Caution Make sure to keep the internal reset state by the LVD circuit or an external reset until V_{DD} reaches the operating voltage range shown in 30.4 AC Characteristics.

2.7 RAM Data Retention Characteristics

(T_A = -40 to +85°C, V_{SS} = 0 V)

| Parameter | Symbol | Conditions | MIN. | TYP. | MAX. | Unit |
|-------------------------------|-------------------|------------|----------------------|------|------|------|
| Data retention supply voltage | V _{DDDR} | | 1.46 ^{Note} | | 5.5 | V |

Note The value depends on the POR detection voltage. When the voltage drops, the data is retained before a POR reset is effected, but data is not retained when a POR reset is effected.

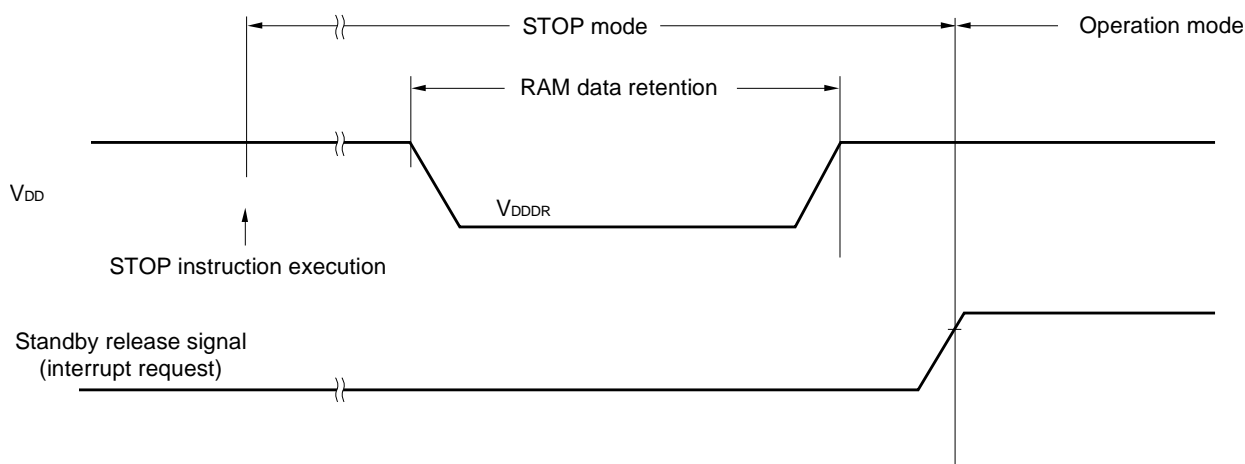

2.8 Flash Memory Programming Characteristics

(T_A = -40 to +85°C, 2.4 V ≤ V_{DD} ≤ 5.5 V, V_{SS} = 0 V)

| Parameter | Symbol | Conditions | MIN. | TYP. | MAX. | Unit |
|--|-------------------|---|---------|-----------|------|-------|
| CPU/peripheral hardware clock frequency | f _{CLK} | 2.4 V ≤ V _{DD} ≤ 5.5 V | 1 | | 24 | MHz |
| Number of code flash rewrites | C _{erwr} | Retaining years: 20 years T _A = +85°C | 1,000 | | | Times |
| Number of data flash rewrites Notes 1, 2, 3 | | Retaining years: 1 year T _A = +25°C | | 1,000,000 | | |
| | | Retaining years: 5 years T _A = +85°C | 100,000 | | | |
| | | Retaining years: 20 years T _A = +85°C | 10,000 | | | |

- Notes**
1. 1 erase + 1 write after the erase is regarded as 1 rewrite. The retaining years are until next rewrite after the rewrite.
 2. When using flash memory programmer and Renesas Electronics self programming library.
 3. These specifications show the characteristics of the flash memory and the results obtained from Renesas Electronics reliability testing.

2.9 Dedicated Flash Memory Programmer Communication (UART)

(T_A = -40 to +85°C, 2.4 V ≤ V_{DD} ≤ 5.5 V, V_{SS} = 0 V)

| Parameter | Symbol | Conditions | MIN. | TYP. | MAX. | Unit |
|---------------|--------|---------------------------|---------|------|-----------|------|
| Transfer rate | | During serial programming | 115,200 | | 1,000,000 | bps |

2.10 Timing Specs for Switching Flash Memory Programming Modes

(T_A = -40 to +85°C, 2.4 V ≤ V_{DD} ≤ 5.5 V, V_{SS} = 0 V)

| Parameter | Symbol | Conditions | MIN. | TYP. | MAX. | Unit |
|---|---------------------|--|------|------|------|------|
| How long from when an external reset ends until the initial communication settings are specified | t _{SUINIT} | POR and LVD reset must end before the external reset ends. | | | 100 | ms |
| How long from when the TOOL0 pin is placed at the low level until an external reset ends | t _{SU} | POR and LVD reset must end before the external reset ends. | 10 | | | μs |
| How long the TOOL0 pin must be kept at the low level after an external reset ends (excluding the processing time of the firmware to control the flash memory) | t _{HD} | POR and LVD reset must end before the external reset ends. | 1 | | | ms |

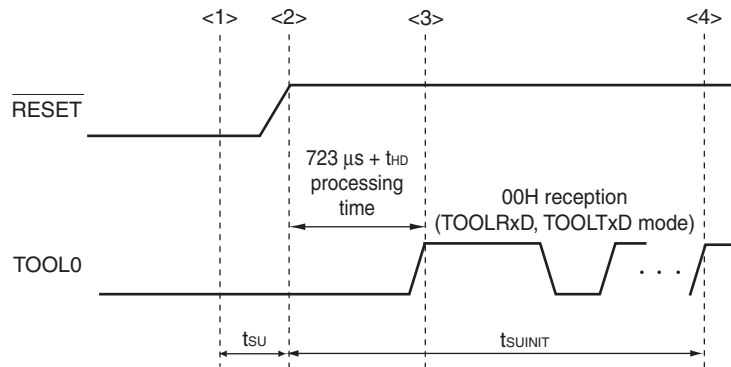

- <1> The low level is input to the TOOL0 pin.
- <2> The external reset ends (POR and LVD reset must end before the external reset ends.).
- <3> The TOOL0 pin is set to the high level.
- <4> Setting of the flash memory programming mode by UART reception and complete the baud rate setting.

Remark t_{SUINIT}: The segment shows that it is necessary to finish specifying the initial communication settings within 100 ms from when the resets end.

t_{SU}: How long from when the TOOL0 pin is placed at the low level until an external reset ends

t_{HD}: How long to keep the TOOL0 pin at the low level from when the external and internal resets end (excluding the processing time of the firmware to control the flash memory)

3.1 Absolute Maximum Ratings

Absolute Maximum Ratings (T_A = 25°C) (1/2)

| Parameter | Symbols | Conditions | Ratings | Unit |
|------------------------------------|---------------------|--|--|------|
| Supply voltage | V _{DD} | | -0.5 to +6.5 | V |
| REGC pin input voltage | V _I REGC | REGC | -0.3 to +2.8 and -0.3 to V _{DD} +0.3 ^{Note 1} | V |
| UV _{DD} pin input voltage | V _I UVDD | UV _{DD} | -0.3 to V _{DD} +0.3 | V |
| Input voltage | V _{I1} | P00, P01, P14 to P17, P20 to P27, P30, P31, P40, P41, P50, P51, P70 to P75, P120 to P124, P137, P140, EXCLK, EXCLKS, RESET | -0.3 to V _{DD} +0.3 ^{Note 2} | V |
| | V _{I2} | P60 to P63 (N-ch open-drain) | -0.3 to +6.5 | V |
| | V _{I3} | UDP0, UDM0, UDP1, UDM1 | -0.3 to +6.5 | V |
| | V _{I4} | UV _{BUS} | -0.3 to +6.5 | V |
| Output voltage | V _{O1} | P00, P01, P14 to P17, P20 to P27, P30, P31, P40, P41, P50, P51, P60 to P63, P70 to P75, P120, P130, P140 | -0.3 to V _{DD} +0.3 ^{Note 2} | V |
| | V _{O2} | UDP0, UDM0, UDP1, UDM1 | -0.3 to +6.5 | V |
| Analog input voltage | V _{AI1} | ANI16, ANI17, ANI19 | -0.3 to V _{DD} +0.3 and -0.3 to AV _{REF} (+) +0.3 Notes 2, 3 | V |
| | V _{AI2} | ANI0 to ANI7 | -0.3 to V _{DD} +0.3 and -0.3 to AV _{REF} (+) +0.3 Notes 2, 3 | V |

- Notes 1.** Connect the REGC pin to V_{SS} via a capacitor (0.47 to 1 μF). This value regulates the absolute maximum rating of the REGC pin. Do not use this pin with voltage applied to it.
- Must be 6.5 V or lower.
 - Do not exceed AV_{REF}(+) + 0.3 V in case of A/D conversion target pin

Caution Product quality may suffer if the absolute maximum rating is exceeded even momentarily for any parameter. That is, the absolute maximum ratings are rated values at which the product is on the verge of suffering physical damage, and therefore the product must be used under conditions that ensure that the absolute maximum ratings are not exceeded.

- Remarks 1.** Unless specified otherwise, the characteristics of alternate-function pins are the same as those of the port pins.
- AV_{REF} (+) : The + side reference voltage of the A/D converter. This can be selected from AV_{REFP}, the internal reference voltage (1.45 V), and V_{DD}.
 - V_{SS} : Reference voltage

Absolute Maximum Ratings (T_A = 25°C) (2/2)

| Parameter | Symbols | Conditions | | Ratings | Unit |
|-------------------------------|----------------------------------|------------------------------|--|--|-------------|
| Output current, high | I _{OH1} | Per pin | P00, P01, P14 to P17, P30, P31, P40, P41, P50, P51, P70 to P75, P120, P130, P140 | -40 | mA |
| | | Total of all pins -170 mA | P00, P01, P40, P41, P120, P130, P140 | -70 | mA |
| | | | P14 to P17, P30, P31, P50, P51, P70 to P75 | -100 | mA |
| | I _{OH2} | Per pin | P20 to P27 | -0.5 | mA |
| | | Total of all pins | | -2 | mA |
| | Output current, low | I _{OL1} | Per pin | P00, P01, P14 to P17, P30, P31, P40, P41, P50, P51, P60 to P63, P70 to P75, P120, P130, P140 | 40 |
| Total of all pins 170 mA | | | P00, P01, P40, P41, P120, P130, P140 | 70 | mA |
| | | | P14 to P17, P30, P31, P50, P51, P60 to P63, P70 to P75 | 100 | mA |
| I _{OL2} | | Per pin | P20 to P27 | 1 | mA |
| | | Total of all pins | | 5 | mA |
| Operating ambient temperature | | T _A | In normal operation mode | | -40 to +105 |
| | In flash memory programming mode | | | | |
| Storage temperature | T _{stg} | | | -65 to +150 | °C |

Caution Product quality may suffer if the absolute maximum rating is exceeded even momentarily for any parameter. That is, the absolute maximum ratings are rated values at which the product is on the verge of suffering physical damage, and therefore the product must be used under conditions that ensure that the absolute maximum ratings are not exceeded.

Remark Unless specified otherwise, the characteristics of alternate-function pins are the same as those of the port pins.

3.2 Oscillator Characteristics

3.2.1 X1, XT1 oscillator characteristics

($T_A = -40$ to $+105^{\circ}\text{C}$, $2.4\text{ V} \leq V_{DD} \leq 5.5\text{ V}$, $V_{SS} = 0\text{ V}$)

| Parameter | Resonator | Conditions | MIN. | TYP. | MAX. | Unit |
|---|---|--|------|--------|------|------|
| X1 clock oscillation frequency (f_X) ^{Note} | Ceramic resonator/ crystal resonator | $2.7\text{ V} \leq V_{DD} \leq 5.5\text{ V}$ | 1.0 | | 20.0 | MHz |
| | | $2.4\text{ V} \leq V_{DD} < 2.7\text{ V}$ | 1.0 | | 16.0 | MHz |
| XT1 clock oscillation frequency (f_{XT1}) ^{Note} | Crystal resonator | | 32 | 32.768 | 35 | kHz |

Note Indicates only permissible oscillator frequency ranges. Refer to AC Characteristics for instruction execution time. Request evaluation by the manufacturer of the oscillator circuit mounted on a board to check the oscillator characteristics.

Caution Since the CPU is started by the high-speed on-chip oscillator clock after a reset release, check the X1 clock oscillation stabilization time using the oscillation stabilization time counter status register (OSTC) by the user. Determine the oscillation stabilization time of the OSTC register and the oscillation stabilization time select register (OSTS) after sufficiently evaluating the oscillation stabilization time with the resonator to be used.

3.2.2 On-chip oscillator characteristics

($T_A = -40$ to $+105^{\circ}\text{C}$, $2.4\text{ V} \leq V_{DD} \leq 5.5\text{ V}$, $V_{SS} = 0\text{ V}$)

| Oscillators | Parameters | Conditions | MIN. | TYP. | MAX. | Unit |
|---|------------|---------------------------------|------|------|------|------|
| High-speed on-chip oscillator clock frequency ^{Notes 1, 2} | f_{HOCO} | | 1 | | 48 | MHz |
| High-speed on-chip oscillator clock frequency accuracy | | -20 to $+85^{\circ}\text{C}$ | -1.0 | | +1.0 | % |
| | | -40 to -20°C | -1.5 | | +1.5 | % |
| | | $+85$ to $+105^{\circ}\text{C}$ | -2.0 | | +2.0 | % |
| Low-speed on-chip oscillator clock frequency | f_{L1} | | | 15 | | kHz |
| Low-speed on-chip oscillator clock frequency accuracy | | | -15 | | +15 | % |

Notes 1. High-speed on-chip oscillator frequency is selected by bits 0 to 3 of option byte (000C2H/010C2H) and bits 0 to 2 of HOCODIV register.

2. This indicates the oscillator characteristics only. Refer to AC Characteristics for instruction execution time.

3.2.3 PLL oscillator characteristics

($T_A = -40$ to $+105^{\circ}\text{C}$, $2.4\text{ V} \leq V_{DD} \leq 5.5\text{ V}$, $V_{SS} = 0\text{ V}$)

| Oscillators | Parameters | Conditions | MIN. | TYP. | MAX. | Unit |
|--------------------------------------|--------------------|--|-------|-------|-------|---------------|
| PLL input frequency ^{Note} | f_{PLLIN} | High-speed system clock | 6.00 | | 16.00 | MHz |
| PLL output frequency ^{Note} | f_{PLL} | | | 48.00 | | MHz |
| Lock up time | | From PLL output enable to stabilization of the output frequency | 40.00 | | | μs |
| Interval time | | From PLL stop to PLL re-operation setting Wait time | 4.00 | | | μs |
| Setting wait time | | From after PLL input clock stabilization and PLL setting is fixed to start setting Wait time required | 1.00 | | | μs |

Note Indicates only oscillator characteristics. Refer to AC Characteristics for instruction execution time.

3.3 DC Characteristics

3.3.1 Pin characteristics

(T_A = -40 to +105°C, 2.4 V ≤ V_{DD} ≤ 5.5 V, V_{SS} = 0 V)

| Items | Symbol | Conditions | MIN. | TYP. | MAX. | Unit | |
|--|---|--|---------------------------------|------|-------|------------------------|----|
| Output current, high ^{Note 1} | I _{OH1} | Per pin for P00, P01, P14 to P17, P30, P31, P40, P41, P50, P51, P70 to P75, P120, P130, P140 | 2.4 V ≤ V _{DD} ≤ 5.5 V | | | -3.0 ^{Note 2} | mA |
| | | Total of P00, P01, P40, P41, P120, P130, P140 (When duty ≤ 70% ^{Note 3}) | 4.0 V ≤ V _{DD} ≤ 5.5 V | | | -30.0 | mA |
| | | | 2.7 V ≤ V _{DD} < 4.0 V | | | -10.0 | mA |
| | | | 2.4 V ≤ V _{DD} < 2.7 V | | | -5.0 | mA |
| | | Total of P14 to P17, P30, P31, P50, P51, P70 to P75 (When duty ≤ 70% ^{Note 3}) | 4.0 V ≤ V _{DD} ≤ 5.5 V | | | -30.0 | mA |
| | | | 2.7 V ≤ V _{DD} < 4.0 V | | | -19.0 | mA |
| | | | 2.4 V ≤ V _{DD} < 2.7 V | | | -10.0 | mA |
| | Total of all pins (When duty ≤ 70% ^{Note 3}) | 2.4 V ≤ V _{DD} ≤ 5.5 V | | | -60.0 | mA | |
| | I _{OH2} | Per pin for P20 to P27 | 2.4 V ≤ V _{DD} ≤ 5.5 V | | | -0.1 ^{Note 2} | mA |
| | | Total of all pins (When duty ≤ 70% ^{Note 3}) | 2.4 V ≤ V _{DD} ≤ 5.5 V | | | -1.5 | mA |

- Notes**
- Value of current at which the device operation is guaranteed even if the current flows from the V_{DD} pin to an output pin.
 - However, do not exceed the total current value.
 - Specification under conditions where the duty factor ≤ 70%.

The output current value that has changed to the duty factor > 70% the duty ratio can be calculated with the following expression (when changing the duty ratio to n%).

- Total output current of pins = (I_{OH} × 0.7)/(n × 0.01)

<Example> Where n = 80% and I_{OH} = -10.0 mA

$$\text{Total output current of pins} = (-10.0 \times 0.7)/(80 \times 0.01) \cong -8.7 \text{ mA}$$

However, the current that is allowed to flow into one pin does not vary depending on the duty factor. A current higher than the absolute maximum rating must not flow into one pin.

Caution P00, P01, P30, and P74 do not output high level in N-ch open-drain mode.

Remark Unless specified otherwise, the characteristics of alternate-function pins are the same as those of the port pins.

(T_A = -40 to +105°C, 2.4 V ≤ V_{DD} ≤ 5.5 V, V_{SS} = 0 V)

| Items | Symbol | Conditions | MIN. | TYP. | MAX. | Unit | |
|---|---|--|---------------------------------|------|------|------------------------|----|
| Output current, I _{OL} ^{Note 1} | I _{OL1} | Per pin for P00, P01, P14 to P17, P30, P31, P40, P41, P50, P51, P70 to P75, P120, P130, P140 | 2.4V ≤ V _{DD} ≤ 5.5 V | | | 8.5 ^{Note 2} | mA |
| | | Per pin for P60 to P63 | 2.4V ≤ V _{DD} ≤ 5.5 V | | | 15.0 ^{Note 2} | mA |
| | | Total of P00, P01, P40, P41, P120, P130, P140 (When duty ≤ 70% ^{Note 3}) | 4.0 V ≤ V _{DD} ≤ 5.5 V | | | 40.0 | mA |
| | | | 2.7 V ≤ V _{DD} < 4.0 V | | | 15.0 | mA |
| | | | 2.4 V ≤ V _{DD} < 2.7 V | | | 9.0 | mA |
| | | Total of P14 to P17, P30, P31, P50, P51, P60 to P63, P70 to P75 (When duty ≤ 70% ^{Note 3}) | 4.0 V ≤ V _{DD} ≤ 5.5 V | | | 40.0 | mA |
| | | | 2.7 V ≤ V _{DD} < 4.0 V | | | 35.0 | mA |
| | 2.4 V ≤ V _{DD} < 2.7 V | | | | 20.0 | mA | |
| | Total of all pins (When duty ≤ 70% ^{Note 3}) | 2.4V ≤ V _{DD} ≤ 5.5 V | | | 80.0 | mA | |
| | I _{OL2} | Per pin for P20 to P27 | 2.4V ≤ V _{DD} ≤ 5.5 V | | | 0.4 ^{Note 2} | mA |
| Total of all pins (When duty ≤ 70% ^{Note 3}) | | 2.4V ≤ V _{DD} ≤ 5.5 V | | | 5.0 | mA | |

Notes 1. Value of current at which the device operation is guaranteed even if the current flows from an output pin to the V_{SS} pin.

2. However, do not exceed the total current value.

3. Specification under conditions where the duty factor ≤ 70%.

The output current value that has changed to the duty factor > 70% the duty ratio can be calculated with the following expression (when changing the duty ratio to n%).

- Total output current of pins = (I_{OL} × 0.7)/(n × 0.01)

<Example> Where n = 80% and I_{OL} = 10.0 mA

$$\text{Total output current of pins} = (10.0 \times 0.7)/(80 \times 0.01) \cong 8.7 \text{ mA}$$

However, the current that is allowed to flow into one pin does not vary depending on the duty factor.

A current higher than the absolute maximum rating must not flow into one pin.

Remark Unless specified otherwise, the characteristics of alternate-function pins are the same as those of the port pins.

($T_A = -40$ to $+105^\circ\text{C}$, $2.4\text{ V} \leq V_{DD} \leq 5.5\text{ V}$, $V_{SS} = 0\text{ V}$)

| Items | Symbol | Conditions | MIN. | TYP. | MAX. | Unit | |
|------------------------|-----------|--|--|-------------|------|-------------|---|
| Input voltage, high | V_{IH1} | P00, P01, P14 to P17, P30, P31, P40, P41, P50, P51, P70 to P75, P120, P140 | Normal input buffer | $0.8V_{DD}$ | | V_{DD} | V |
| | V_{IH2} | P00, P01, P30, P50 | TTL input buffer $4.0\text{ V} \leq V_{DD} \leq 5.5\text{ V}$ | 2.2 | | V_{DD} | V |
| | | | TTL input buffer $3.3\text{ V} \leq V_{DD} < 4.0\text{ V}$ | 2.0 | | V_{DD} | V |
| | | | TTL input buffer $2.4\text{ V} \leq V_{DD} < 3.3\text{ V}$ | 1.5 | | V_{DD} | V |
| | V_{IH3} | P20 to P27 | | $0.7V_{DD}$ | | V_{DD} | V |
| | V_{IH4} | P60 to P63 | | $0.7V_{DD}$ | | 6.0 | V |
| | V_{IH5} | P121 to P124, P137, EXCLK, EXCLKS, $\overline{\text{RESET}}$ | | $0.8V_{DD}$ | | V_{DD} | V |
| Input voltage, low | V_{IL1} | P00, P01, P14 to P17, P30, P31, P40, P41, P50, P51, P70 to P75, P120, P140 | Normal input buffer | 0 | | $0.2V_{DD}$ | V |
| | V_{IL2} | P00, P01, P30, P50 | TTL input buffer $4.0\text{ V} \leq V_{DD} \leq 5.5\text{ V}$ | 0 | | 0.8 | V |
| | | | TTL input buffer $3.3\text{ V} \leq V_{DD} < 4.0\text{ V}$ | 0 | | 0.5 | V |
| | | | TTL input buffer $2.4\text{ V} \leq V_{DD} < 3.3\text{ V}$ | 0 | | 0.32 | V |
| | V_{IL3} | P20 to P27 | | 0 | | $0.3V_{DD}$ | V |
| | V_{IL4} | P60 to P63 | | 0 | | $0.3V_{DD}$ | V |
| | V_{IL5} | P121 to P124, P137, EXCLK, EXCLKS, $\overline{\text{RESET}}$ | | 0 | | $0.2V_{DD}$ | V |

Caution The maximum value of V_{IH} of pins P00, P01, P30, and P74 is V_{DD} , even in the N-ch open-drain mode.

Remark Unless specified otherwise, the characteristics of alternate-function pins are the same as those of the port pins.

($T_A = -40$ to $+105^{\circ}\text{C}$, $2.4\text{ V} \leq V_{DD} \leq 5.5\text{ V}$, $V_{SS} = 0\text{ V}$)

| Items | Symbol | Conditions | MIN. | TYP. | MAX. | Unit |
|--|------------------|--|--|-----------------------|------|------|
| Output voltage, high | V _{OH1} | P00, P01, P14 to P17, P30, P31, P40, P41, P50, P51, P70 to P75, P120, P130, P140 | 4.0 V \leq V _{DD} \leq 5.5 V, I _{OH1} = -3.0 mA | V _{DD} - 0.7 | | V |
| | | | 2.7 V \leq V _{DD} \leq 5.5 V, I _{OH1} = -2.0 mA | V _{DD} - 0.6 | | V |
| | | | 2.4 V \leq V _{DD} \leq 5.5 V, I _{OH1} = -1.5 mA | V _{DD} - 0.5 | | V |
| | V _{OH2} | P20 to P27 | 2.4 V \leq V _{DD} \leq 5.5 V, I _{OH2} = -100 μ A | V _{DD} - 0.5 | | V |
| Output voltage, low | V _{OL1} | P00, P01, P14 to P17, P30, P31, P40, P41, P50, P51, P70 to P75, P120, P130, P140 | 4.0 V \leq V _{DD} \leq 5.5 V, I _{OL1} = 8.5 mA | | 0.7 | V |
| | | | 2.7 V \leq V _{DD} \leq 5.5 V, I _{OL1} = 3.0 mA | | 0.6 | V |
| | | | 2.7 V \leq V _{DD} \leq 5.5 V, I _{OL1} = 1.5 mA | | 0.4 | V |
| | | | 2.4 V \leq V _{DD} \leq 5.5 V, I _{OL1} = 0.6 mA | | 0.4 | V |
| | V _{OL2} | P20 to P27 | 2.4 V \leq V _{DD} \leq 5.5 V, I _{OL2} = 400 μ A | | 0.4 | V |
| | V _{OL3} | P60 to P63 | 4.0 V \leq V _{DD} \leq 5.5 V, I _{OL1} = 15.0 mA | | 2.0 | V |
| | | | 4.0 V \leq V _{DD} \leq 5.5 V, I _{OL1} = 5.0 mA | | 0.4 | V |
| | | | 2.7 V \leq V _{DD} \leq 5.5 V, I _{OL1} = 3.0 mA | | 0.4 | V |
| 2.4 V \leq V _{DD} \leq 5.5 V, I _{OL1} = 2.0 mA | | | | 0.4 | V | |

Caution P00, P01, P30, and P74 do not output high level in N-ch open-drain mode.

Remark Unless specified otherwise, the characteristics of alternate-function pins are the same as those of the port pins.

($T_A = -40$ to $+105^\circ\text{C}$, $2.4\text{ V} \leq V_{DD} \leq 5.5\text{ V}$, $V_{SS} = 0\text{ V}$)

| Items | Symbol | Conditions | MIN. | TYP. | MAX. | Unit | | |
|-----------------------------|-----------|---|--------------------------------|---------------------------------------|------|------|------------------|---------------|
| Input leakage current, high | I_{LH1} | P00, P01, P14 to P17, P20 to P27, P30, P31, P40, P41, P50, P51, P60 to P63, P70 to P75, P120, P137, P140, $\overline{\text{RESET}}$ | $V_i = V_{DD}$ | | | 1 | μA | |
| | I_{LH2} | P121 to P124 (X1, X2, XT1, XT2, EXCLK, EXCLKS) | $V_i = V_{DD}$ | In input port or external clock input | | | 1 | μA |
| | | | | In resonator connection | | | 10 | μA |
| Input leakage current, low | I_{Ll1} | P00, P01, P14 to P17, P20 to P27, P30, P31, P40, P41, P50, P51, P60 to P63, P70 to P75, P120, P137, P140, $\overline{\text{RESET}}$ | $V_i = V_{SS}$ | | | -1 | μA | |
| | I_{Ll2} | P121 to P124 (X1, X2, XT1, XT2, EXCLK, EXCLKS) | $V_i = V_{SS}$ | In input port or external clock input | | | -1 | μA |
| | | | | In resonator connection | | | -10 | μA |
| On-chip pll-up resistance | R_U | P00, P01, P14 to P17, P30, P31, P40, P41, P50, P51, P70 to P75, P120, P140 | $V_i = V_{SS}$, In input port | 10 | 20 | 100 | $\text{k}\Omega$ | |

Remark Unless specified otherwise, the characteristics of alternate-function pins are the same as those of the port pins.

3.3.2 Supply current characteristics

(T_A = -40 to +105°C, 2.4 V ≤ V_{DD} ≤ 5.5 V, V_{SS} = 0 V)

(1/2)

| Parameter | Symbol | Conditions | | | | MIN. | TYP. | MAX. | Unit | |
|--|------------------|----------------------|---|--|---|-------------------------|----------------------|------|------|----|
| Supply current Note 1 | I _{DD1} | Operating mode | HS (High-speed main) mode Note 6 | f _{HOCO} = 48 MHz f _{IH} = 24 MHz Note 3 | Basic operation | V _{DD} = 5.0 V | 1.7 | | mA | |
| | | | | | | V _{DD} = 3.0 V | 1.7 | | mA | |
| | | | | | Normal operation | V _{DD} = 5.0 V | 3.7 | 5.8 | mA | |
| | | | | | | V _{DD} = 3.0 V | 3.7 | 5.8 | mA | |
| | | | | f _{HOCO} = 24 MHz Note 5 f _{IH} = 12 MHz Note 3 | Normal operation | V _{DD} = 5.0 V | 2.3 | 3.4 | mA | |
| | | | | | | V _{DD} = 3.0 V | 2.3 | 3.4 | mA | |
| | | | | f _{HOCO} = 12 MHz Note 5 f _{IH} = 6 MHz Note 3 | Normal operation | V _{DD} = 5.0 V | 1.6 | 2.2 | mA | |
| | | | | | | V _{DD} = 3.0 V | 1.6 | 2.2 | mA | |
| | | | | f _{HOCO} = 6 MHz Note 5 f _{IH} = 3 MHz Note 3 | Normal operation | V _{DD} = 5.0 V | 1.2 | 1.6 | mA | |
| | | | | | | V _{DD} = 3.0 V | 1.2 | 1.6 | mA | |
| | | | | HS (High-speed main) mode Note 6 | f _{MX} = 20 MHz Note 2, V _{DD} = 5.0 V | Normal operation | Square wave input | 3.0 | 4.9 | mA |
| | | | | | | | Resonator connection | 3.2 | 5.0 | mA |
| | | | f _{MX} = 20 MHz Note 2, V _{DD} = 3.0 V | | Normal operation | Square wave input | 3.0 | 4.9 | mA | |
| | | | | | | Resonator connection | 3.2 | 5.0 | mA | |
| | | | f _{MX} = 10 MHz Note 2, V _{DD} = 5.0 V | | Normal operation | Square wave input | 1.9 | 2.9 | mA | |
| | | | | | | Resonator connection | 1.9 | 2.9 | mA | |
| | | | f _{MX} = 10 MHz Note 2, V _{DD} = 3.0 V | | Normal operation | Square wave input | 1.9 | 2.9 | mA | |
| | | | | | | Resonator connection | 1.9 | 2.9 | mA | |
| | | | HS (High-speed main) mode (PLL operation) Note 6 | f _{PLL} = 48 MHz, f _{CLK} = 24 MHz Note 2 | Normal operation | V _{DD} = 5.0 V | 4.0 | 6.3 | mA | |
| | | | | | | V _{DD} = 3.0 V | 4.0 | 6.3 | mA | |
| | | | | f _{PLL} = 48 MHz, f _{CLK} = 12 MHz Note 2 | Normal operation | V _{DD} = 5.0 V | 2.6 | 3.9 | mA | |
| | | | | | | V _{DD} = 3.0 V | 2.6 | 3.9 | mA | |
| | | | Subsystem clock operation | f _{SUB} = 32.768 kHz Note 4 T _A = -40°C | Normal operation | Resonator connection | 4.1 | 4.9 | μA | |
| | | | | | | Square wave input | 4.2 | 5.0 | μA | |
| | | | | f _{SUB} = 32.768 kHz Note 4 T _A = +25°C | Normal operation | Square wave input | 4.1 | 4.9 | μA | |
| | | | | | | Resonator connection | 4.2 | 5.0 | μA | |
| | | | | f _{SUB} = 32.768 kHz Note 4 T _A = +50°C | Normal operation | Square wave input | 4.2 | 5.5 | μA | |
| | | | | | | Resonator connection | 4.3 | 5.6 | μA | |
| | | | | f _{SUB} = 32.768 kHz Note 4 T _A = +70°C | Normal operation | Square wave input | 4.2 | 6.3 | μA | |
| | | | | | | Resonator connection | 4.3 | 6.4 | μA | |
| f _{SUB} = 32.768 kHz Note 4 T _A = +85°C | Normal operation | Square wave input | 4.8 | 7.7 | μA | | | | | |
| | | Resonator connection | 4.9 | 7.8 | μA | | | | | |
| f _{SUB} = 32.768 kHz Note 4 T _A = +105°C | Normal operation | Square wave input | 6.9 | 19.7 | μA | | | | | |
| | | Resonator connection | 7.0 | 19.8 | μA | | | | | |

(Notes and Remarks are listed on the next page.)

- Notes**
1. Total current flowing into V_{DD}, including the input leakage current flowing when the level of the input pin is fixed to V_{DD}, or V_{SS}. The values below the MAX. column include the peripheral operation current. However, not including the current flowing into the A/D converter, LVD circuit, I/O port, and on-chip pull-up/pull-down resistors and the current flowing during data flash rewrite.
 2. When high-speed on-chip oscillator and subsystem clock are stopped.
 3. When high-speed system clock and subsystem clock are stopped.
 4. When high-speed on-chip oscillator and high-speed system clock are stopped. When AMPHS1 = 1 (Ultra-low power consumption oscillation). However, not including the current flowing into the RTC, 12-bit interval timer, and watchdog timer.
 5. When Operating frequency setting of option byte = 48 MHz. When f_{HOCO} is divided by HOCODIV. When RDIV[1:0] = 00 (divided by 2: default).
 6. Relationship between operation voltage width, operation frequency of CPU and operation mode is as below.

| | |
|----------------------------|---|
| HS (high-speed main) mode: | 2.7 V ≤ V _{DD} ≤ 5.5 V@1 MHz to 24 MHz |
| | 2.4 V ≤ V _{DD} ≤ 5.5 V@1 MHz to 16 MHz |

- Remarks**
1. f_{HOCO}: High-speed on-chip oscillator clock frequency (Max. 48 MHz)
 2. f_{IH}: Main system clock source frequency obtained by dividing the high-speed on-chip oscillator clock by 2, 4, or 8 (Max. 24 MHz)
 3. f_{MX}: High-speed system clock frequency (X1 clock oscillation frequency or external main system clock frequency)
 4. f_{PLL}: PLL oscillation frequency
 5. f_{SUB}: Subsystem clock frequency (XT1 clock oscillation frequency)
 6. f_{CLK}: CPU/peripheral hardware clock frequency
 7. Except subsystem clock operation, temperature condition of the TYP. value is T_A = 25°C.

(T_A = -40 to +105°C, 2.4 V ≤ V_{DD} ≤ 5.5 V, V_{SS} = 0 V)

(2/2)

| Parameter | Symbol | Conditions | | MIN. | TYP. | MAX. | Unit | |
|--------------------------|----------------------------|---|--|--|-------------------------|------|------|----|
| Supply current Note 1 | I _{DD2} Note 2 | HALT mode | HS (High-speed main) mode Note 9 | f _{HOCO} = 48 MHz | V _{DD} = 5.0 V | 0.67 | 2.25 | mA |
| | | | | f _{IH} = 24 MHz Note 4 | V _{DD} = 3.0 V | 0.67 | 2.25 | mA |
| | | | | f _{HOCO} = 24 MHz Note 7 | V _{DD} = 5.0 V | 0.50 | 1.55 | mA |
| | | | | f _{IH} = 12 MHz Note 4 | V _{DD} = 3.0 V | 0.50 | 1.55 | mA |
| | | | | f _{HOCO} = 12 MHz Note 7 | V _{DD} = 5.0 V | 0.41 | 1.21 | mA |
| | | | | f _{IH} = 6 MHz Note 4 | V _{DD} = 3.0 V | 0.41 | 1.21 | mA |
| | | | f _{HOCO} = 6 MHz Note 7 | V _{DD} = 5.0 V | 0.37 | 1.05 | mA | |
| | | | f _{IH} = 3 MHz Note 4 | V _{DD} = 3.0 V | 0.37 | 1.05 | mA | |
| | | | HS (High-speed main) mode Note 9 | f _{MX} = 20 MHz Note 3, V _{DD} = 5.0 V | Square wave input | 0.28 | 1.90 | mA |
| | | | | | Resonator connection | 0.45 | 2.00 | mA |
| | | | | f _{MX} = 20 MHz Note 3, V _{DD} = 3.0 V | Square wave input | 0.28 | 1.90 | mA |
| | | | | | Resonator connection | 0.45 | 2.00 | mA |
| | | | | f _{MX} = 10 MHz Note 3, V _{DD} = 5.0 V | Square wave input | 0.19 | 1.02 | mA |
| | | | | | Resonator connection | 0.26 | 1.10 | mA |
| | | | f _{MX} = 10 MHz Note 3, V _{DD} = 3.0 V | Square wave input | 0.19 | 1.02 | mA | |
| | | | | Resonator connection | 0.26 | 1.10 | mA | |
| | | | HS (High-speed main) mode (PLL operation) Note 9 | f _{PLL} = 48 MHz, f _{CLK} = 24 MHz Note 3 | V _{DD} = 5.0 V | 0.91 | 2.74 | mA |
| | | | | | V _{DD} = 3.0 V | 0.91 | 2.74 | mA |
| | | f _{PLL} = 48 MHz, f _{CLK} = 12 MHz Note 3 | | V _{DD} = 5.0 V | 0.85 | 2.31 | mA | |
| | | | | V _{DD} = 3.0 V | 0.85 | 2.31 | mA | |
| | | Subsystem clock operation | f _{SUB} = 32.768 kHz Note 5 T _A = -40°C | Square wave input | 0.25 | 0.57 | μA | |
| | | | | Resonator connection | 0.44 | 0.76 | μA | |
| | | | f _{SUB} = 32.768 kHz Note 5 T _A = +25°C | Square wave input | 0.30 | 0.57 | μA | |
| | | | | Resonator connection | 0.49 | 0.76 | μA | |
| | | | f _{SUB} = 32.768 kHz Note 5 T _A = +50°C | Square wave input | 0.33 | 1.17 | μA | |
| | | | | Resonator connection | 0.63 | 1.36 | μA | |
| | | | f _{SUB} = 32.768 kHz Note 5 T _A = +70°C | Square wave input | 0.46 | 1.97 | μA | |
| | | | | Resonator connection | 0.76 | 2.16 | μA | |
| | | f _{SUB} = 32.768 kHz Note 5 T _A = +85°C | Square wave input | 0.97 | 3.37 | μA | | |
| | | | Resonator connection | 1.16 | 3.56 | μA | | |
| | | f _{SUB} = 32.768 kHz Note 5 T _A = +105°C | Square wave input | 3.01 | 15.37 | μA | | |
| | | | Resonator connection | 3.20 | 15.56 | μA | | |
| I _{DD3} Note 6 | STOP mode Note 8 | T _A = -40°C | | 0.18 | 0.50 | μA | | |
| | | T _A = +25°C | | 0.23 | 0.50 | μA | | |
| | | T _A = +50°C | | 0.26 | 1.10 | μA | | |
| | | T _A = +70°C | | 0.29 | 1.90 | μA | | |
| | | T _A = +85°C | | 0.90 | 3.30 | μA | | |
| | | T _A = +105°C | | 2.94 | 15.30 | μA | | |

(Notes and Remarks are listed on the next page.)

- Notes**
1. Total current flowing into V_{DD} , including the input leakage current flowing when the level of the input pin is fixed to V_{DD} or V_{SS} . The values below the MAX. column include the peripheral operation current. However, not including the current flowing into the A/D converter, LVD circuit, USB2.0 host/function module, I/O port, and on-chip pull-up/pull-down resistors and the current flowing during data flash rewrite.
 2. During HALT instruction execution by flash memory.
 3. When high-speed on-chip oscillator and subsystem clock are stopped.
 4. When high-speed system clock and subsystem clock are stopped.
 5. When high-speed on-chip oscillator and high-speed system clock are stopped. When $RTCLPC = 1$ and setting ultra-low current consumption ($AMPHS1 = 1$). The current flowing into the RTC is included. However, not including the current flowing into the 12-bit interval timer and watchdog timer.
 6. Not including the current flowing into the RTC, 12-bit interval timer, and watchdog timer.
 7. When Operating frequency setting of option byte = 48 MHz. When f_{HOCO} is divided by $HOCODIV$. When $RDIV[1:0] = 00$ (divided by 2: default).
 8. Regarding the value for current to operate the subsystem clock in STOP mode, refer to that in HALT mode.
 9. Relationship between operation voltage width, operation frequency of CPU and operation mode is as below.

| | |
|----------------------------|--|
| HS (high-speed main) mode: | $2.7\text{ V} \leq V_{DD} \leq 5.5\text{ V}@1\text{ MHz to }24\text{ MHz}$ |
| | $2.4\text{ V} \leq V_{DD} \leq 5.5\text{ V}@1\text{ MHz to }16\text{ MHz}$ |

- Remarks**
1. f_{HOCO} : High-speed on-chip oscillator clock frequency (Max. 48 MHz)
 2. f_{IH} : Main system clock source frequency obtained by dividing the high-speed on-chip oscillator clock by 2, 4, or 8 (Max. 24 MHz)
 3. f_{MX} : High-speed system clock frequency (X1 clock oscillation frequency or external main system clock frequency)
 4. f_{PLL} : PLL oscillation frequency
 5. f_{SUB} : Subsystem clock frequency (XT1 clock oscillation frequency)
 6. f_{CLK} : CPU/peripheral hardware clock frequency
 7. Except subsystem clock operation, temperature condition of the TYP. value is $T_A = 25^\circ\text{C}$.

($T_A = -40$ to $+105^\circ\text{C}$, $2.4\text{ V} \leq V_{DD} \leq 5.5\text{ V}$, $V_{SS} = 0\text{ V}$) (1/2)

| Parameter | Symbol | Conditions | | MIN. | TYP. | MAX. | Unit |
|--|-----------------------------------|----------------------------------|--|------|------|-------|---------------|
| Low-speed on-chip oscillator operating current | I_{FIL} ^{Note 1} | | | | 0.20 | | μA |
| RTC operating current | I_{RTC} Notes 1, 2, 3 | | | | 0.02 | | μA |
| 12-bit interval timer operating current | I_{IT} ^{Notes 1, 2, 4} | | | | 0.02 | | μA |
| Watchdog timer operating current | I_{WDT} Notes 1, 2, 5 | $f_{IL} = 15\text{ kHz}$ | | | 0.22 | | μA |
| A/D converter operating current | I_{ADC} ^{Notes 1, 6} | When conversion at maximum speed | Normal mode, $AV_{REFP} = V_{DD} = 5.0\text{ V}$ | | 1.3 | 1.8 | mA |
| | | | Low voltage mode, $AV_{REFP} = V_{DD} = 3.0\text{ V}$ | | 0.5 | 0.8 | mA |
| A/D converter reference voltage current | I_{ADREF} ^{Note 1} | | | | 75.0 | | μA |
| Temperature sensor operating current | I_{TMPS} ^{Note 1} | | | | 75.0 | | μA |
| LVD operating current | I_{LVD} ^{Notes 1, 7} | | | | 0.08 | | μA |
| Self-programming operating current | I_{FSP} ^{Notes 1, 9} | | | | 2.00 | 12.30 | mA |
| BGO operating current | I_{BGO} ^{Notes 1, 8} | | | | 2.00 | 12.30 | mA |
| SNOOZE operating current | I_{SNOZ} ^{Note 1} | ADC operation | The mode is performed ^{Note 10} | | 0.80 | 1.97 | mA |
| | | | The A/D conversion operations are performed, Low voltage mode, $AV_{REFP} = V_{DD} = 3.0\text{ V}$ | | 1.20 | 3.00 | mA |
| | | CSI operation | | 0.70 | 1.56 | mA | |

(Notes and Remarks are listed on the next page.)

(T_A = -40 to +105°C, 2.4 V ≤ V_{DD} ≤ 5.5 V, V_{SS} = 0 V) (2/2)

| Parameter | Symbol | Conditions | MIN. | TYP. | MAX. | Unit |
|-----------------------|------------------------------|---|------|------|------|------|
| USB operating current | I _{USBH} Note 11 | During USB communication operation under the following settings and conditions (V _{DD} = 5.0 V, T _A = +25°C): <ul style="list-style-type: none"> • The internal power supply for the USB is used. • X1 oscillation frequency (f_x) = 12 MHz, PLL oscillation frequency (f_{PLL}) = 48 MHz • The host controller (via two ports) is set to operate in full-speed mode with four pipes (end points) used simultaneously. (PIPE4: Bulk OUT transfer (64 bytes), PIPE5: Bulk IN transfer (64 bytes), PIPE6: Interrupt OUT transfer, PIPE7: Interrupt IN transfer). • The USB ports (two ports) are individually connected to a peripheral function via a 0.5 m USB cable. | | 9.0 | | mA |
| | I _{USBF} Note 11 | During USB communication operation under the following settings and conditions (V _{DD} = 5.0 V, T _A = +25°C): <ul style="list-style-type: none"> • The internal power supply for the USB is used. • X1 oscillation frequency (f_x) = 12 MHz, PLL oscillation frequency (f_{PLL}) = 48 MHz • The function controller is set to operate in full-speed mode with four pipes (end points) used simultaneously. (PIPE4: Bulk OUT transfer (64 bytes), PIPE5: Bulk IN transfer (64 bytes), PIPE6: Interrupt OUT transfer, PIPE7: Interrupt IN transfer). • The USB port (one port) is connected to the host device via a 0.5 m USB cable. | | 2.5 | | mA |
| | I _{SUSP} Note 12 | During suspended state under the following settings and conditions (V _{DD} = 5.0 V, T _A = +25°C): <ul style="list-style-type: none"> • The function controller is set to full-speed mode (the UDP0 pin is pulled up). • The internal power supply for the USB is used. • The system is set to STOP mode (When the high-speed on-chip oscillator, high-speed system clock, and subsystem clock are stopped. When the watchdog timer is stopped.). • The USB port (one port) is connected to the host device via a 0.5 m USB cable. | | 240 | | μA |

(Notes and Remarks are listed on the next page.)

- Notes**
1. Current flowing to V_{DD} .
 2. When high speed on-chip oscillator and high-speed system clock are stopped.
 3. Current flowing only to the real-time clock (RTC) (excluding the operating current of the low-speed on-chip oscillator and the XT1 oscillator). The supply current of the RL78 microcontrollers is the sum of the values of either I_{DD1} or I_{DD2} , and I_{RTC} , when the real-time clock operates in operation mode or HALT mode. When the low-speed on-chip oscillator is selected, I_{FIL} should be added. I_{DD2} subsystem clock operation includes the operational current of the real-time clock.
 4. Current flowing only to the 12-bit interval timer (excluding the operating current of the low-speed on-chip oscillator and the XT1 oscillator). The supply current of the RL78 microcontrollers is the sum of the values of either I_{DD1} or I_{DD2} , and I_{IT} , when the 12-bit interval timer operates in operation mode or HALT mode. When the low-speed on-chip oscillator is selected, I_{FIL} should be added.
 5. Current flowing only to the watchdog timer (including the operating current of the low-speed on-chip oscillator). The supply current of the RL78 microcontrollers is the sum of I_{DD1} , I_{DD2} or I_{DD3} and I_{WDT} when the watchdog timer is in operation.
 6. Current flowing only to the A/D converter. The supply current of the RL78 microcontrollers is the sum of I_{DD1} or I_{DD2} and I_{ADC} when the A/D converter operates in an operation mode or the HALT mode.
 7. Current flowing only to the LVD circuit. The current value of the RL78/G1C is the sum of I_{DD1} , I_{DD2} or I_{DD3} and I_{LVI} when the LVD circuit operates in the Operating, HALT or STOP mode.
 8. Current flowing only during data flash rewrite.
 9. Current flowing only during self programming.
 10. For shift time to the SNOOZE mode.
 11. Current consumed only by the USB module and the internal power supply for the USB.
 12. Includes the current supplied from the pull-up resistor of the UDP0 pin to the pull-down resistor of the host device, in addition to the current consumed by this MCU during the suspended state.

- Remarks**
1. f_{IL} : Low-speed on-chip oscillator clock frequency
 2. f_{SUB} : Subsystem clock frequency (XT1 clock oscillation frequency)
 3. f_{CLK} : CPU/peripheral hardware clock frequency
 4. Temperature condition of the TYP. value is $T_A = 25^{\circ}\text{C}$

3.4 AC Characteristics

3.4.1 Basic operation

(T_A = -40 to +105°C, 2.4 V ≤ V_{DD} ≤ 5.5 V, V_{SS} = 0 V)

| Items | Symbol | Conditions | | MIN. | TYP. | MAX. | Unit | |
|---|---------------------------------------|--|---------------------------------|---------------------------------|---------|------|------|----|
| Instruction cycle (minimum instruction execution time) | T _{CY} | Main system clock (f _{MAIN}) operation | HS (High-speed main) mode | 2.7 V ≤ V _{DD} ≤ 5.5 V | 0.04167 | | 1 | μs |
| | | | | 2.4 V ≤ V _{DD} < 2.7 V | 0.0625 | | 1 | μs |
| | | Subsystem clock (f _{SUB}) operation | | 2.4 V ≤ V _{DD} ≤ 5.5 V | 28.5 | 30.5 | 31.3 | μs |
| | | In the self programming mode | HS (High-speed main) mode | 2.7 V ≤ V _{DD} ≤ 5.5 V | 0.04167 | | 1 | μs |
| | 2.4 V ≤ V _{DD} < 2.7 V | | 0.0625 | | 1 | μs | | |
| External system clock frequency | f _{EX} | 2.7 V ≤ V _{DD} ≤ 5.5 V | | 1.0 | | 20.0 | MHz | |
| | | 2.4 V ≤ V _{DD} < 2.7 V | | 1.0 | | 16.0 | MHz | |
| | f _{EXS} | | | 32 | | 35 | kHz | |
| External system clock input high-level width, low-level width | t _{EXH} , t _{EXL} | 2.7 V ≤ V _{DD} ≤ 5.5 V | | 24 | | | ns | |
| | | 2.4 V ≤ V _{DD} < 2.7 V | | 30 | | | ns | |
| | t _{EXHS} , t _{EXLS} | | | 13.7 | | | μs | |
| TI00 to TI03 input high-level width, low-level width | t _{TIH} , t _{TIL} | | | 1/f _{MCK} +10 | | | ns | |
| TO00 to TO03 output frequency | f _{TO} | High-speed main mode | 4.0 V ≤ V _{DD} ≤ 5.5 V | | | 12 | MHz | |
| | | | 2.7 V ≤ V _{DD} < 4.0 V | | | 8 | MHz | |
| | | | 2.4 V ≤ V _{DD} < 2.7 V | | | 4 | MHz | |
| PCLBUZ0, PCLBUZ1 output frequency | f _{PCL} | High-speed main mode | 4.0 V ≤ V _{DD} ≤ 5.5 V | | | 16 | MHz | |
| | | | 2.7 V ≤ V _{DD} < 4.0 V | | | 8 | MHz | |
| | | | 2.4 V ≤ V _{DD} < 2.7 V | | | 4 | MHz | |
| Interrupt input high-level width, low-level width | t _{INTH} , t _{INTL} | INTP0 to INTP6, INTP8, INTP9 | 2.4 V ≤ V _{DD} ≤ 5.5 V | 1 | | | μs | |
| Key interrupt input low-level width | t _{KR} | KR0 to KR5 | 2.4 V ≤ V _{DD} ≤ 5.5 V | 250 | | | ns | |
| RESET low-level width | t _{RSL} | | | 10 | | | μs | |

Remark f_{MCK}: Timer array unit operation clock frequency

(Operation clock to be set by the CKS0n bit of timer mode register 0n (TMR0n). n: Channel number (n = 0 to 3))

Minimum Instruction Execution Time during Main System Clock Operation

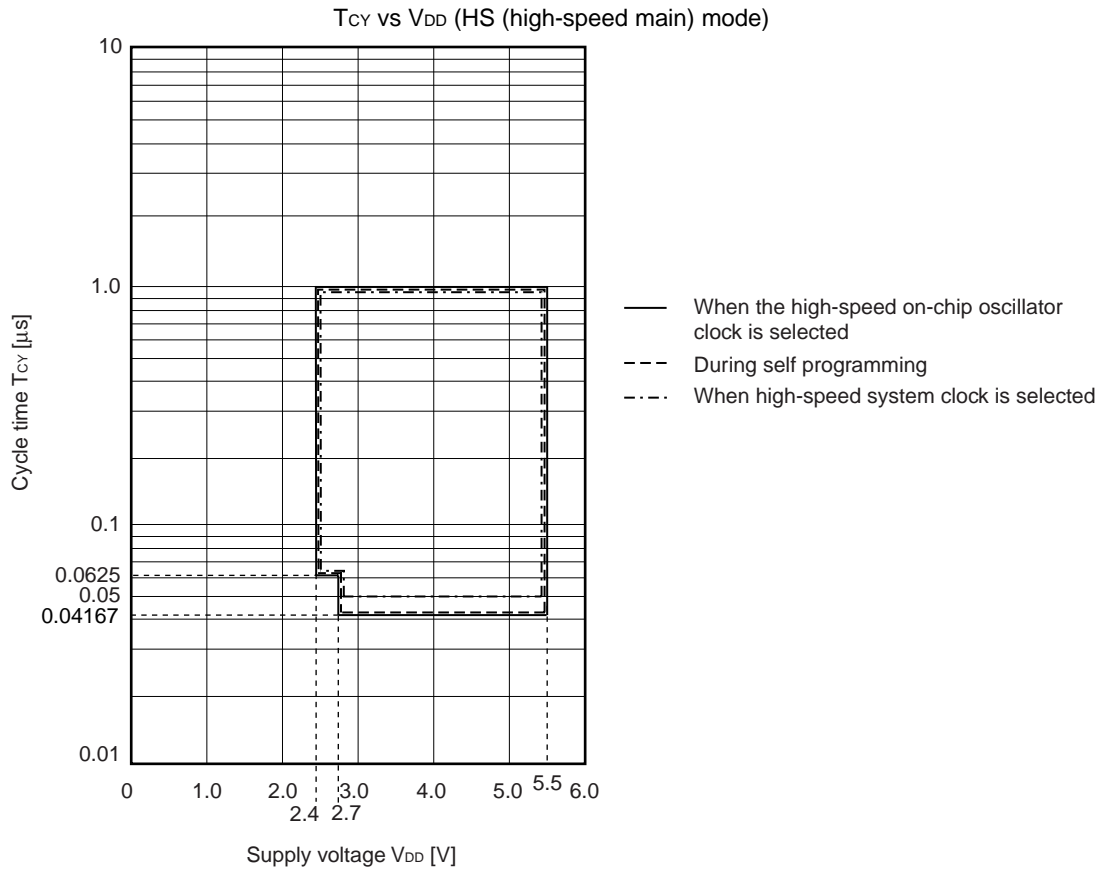

AC Timing Test Points

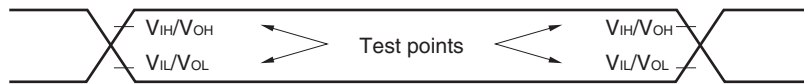

External System Clock Timing

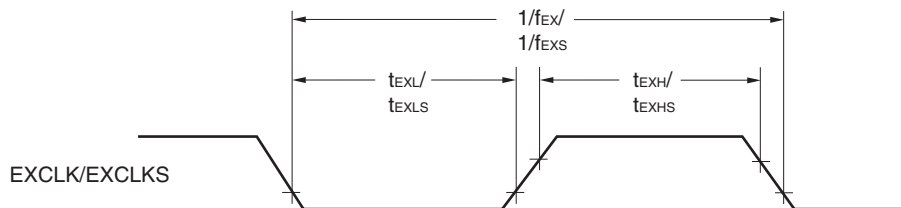

TI/TO Timing

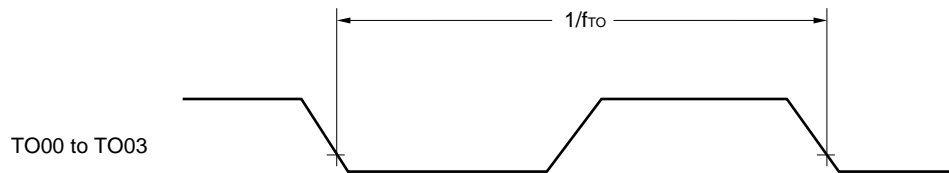
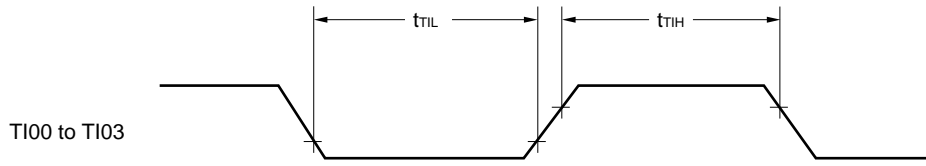

Interrupt Request Input Timing

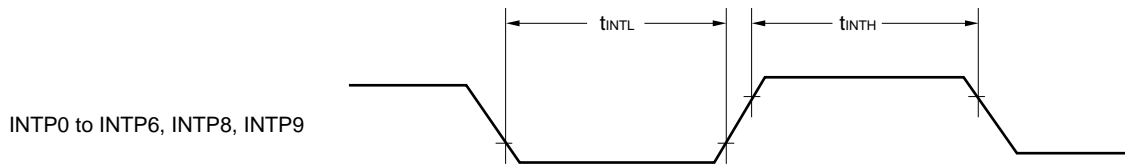

Key Interrupt Input Timing

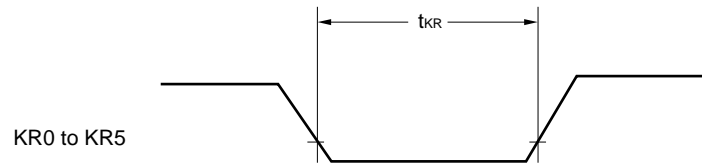

RESET Input Timing

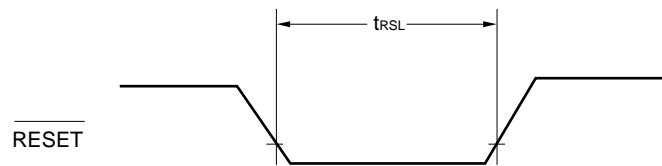

3.5 Peripheral Functions Characteristics

3.5.1 Serial array unit

(1) During communication at same potential (UART mode) (dedicated baud rate generator output)
 (T_A = -40 to +105°C, 2.4 V ≤ V_{DD} ≤ 5.5 V, V_{SS} = 0 V)

| Parameter | Symbol | Conditions | MIN. | TYP. | MAX. | Unit |
|---------------|--------|---|------|------|----------------------|------|
| Transfer rate | | | | | f _{MCK} /12 | bps |
| | | Theoretical value of the maximum transfer rate f _{MCK} = f _{CLK} <small>Note</small> | | | 2.0 | Mbps |

Note The maximum operating frequencies of the CPU/peripheral hardware clock (f_{CLK}) are:

HS (high-speed main) mode: 24 MHz (2.7 V ≤ V_{DD} ≤ 5.5 V)

16 MHz (2.4 V ≤ V_{DD} ≤ 5.5 V)

Caution Select the normal input buffer for the RxDq pin and the normal output mode for the TxDq pin by using port input mode register g (PIMg) and port output mode register g (POMg).

UART mode connection diagram (during communication at same potential)

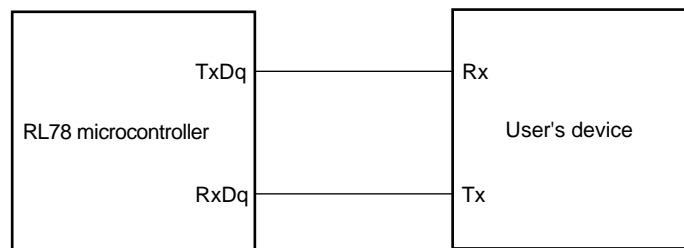

UART mode bit width (during communication at same potential) (reference)

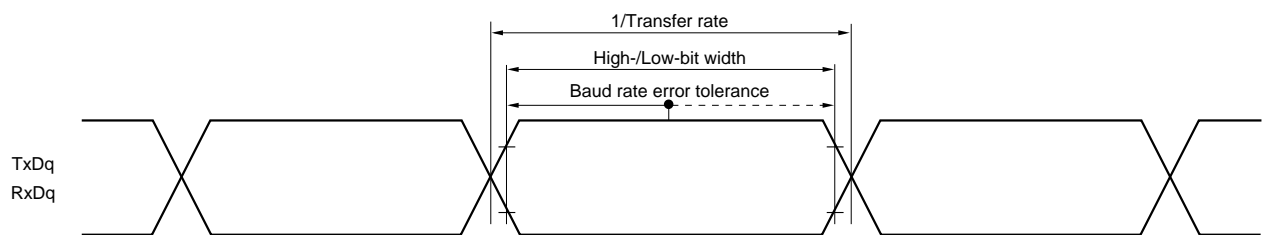

- Remarks**
- q: UART number (q = 0), g: PIM and POM number (g = 5)
 - f_{MCK}: Serial array unit operation clock frequency
 (Operation clock to be set by the CKSmn bit of serial mode register mn (SMRmn). m: Unit number, n: Channel number (mn = 00))

(2) During communication at same potential (CSI mode) (master mode, SCKp... internal clock output)
($T_A = -40$ to $+105^{\circ}\text{C}$, $2.4\text{ V} \leq V_{DD} \leq 5.5\text{ V}$, $V_{SS} = 0\text{ V}$)

| Parameter | Symbol | Conditions | MIN. | TYP. | MAX. | Unit |
|---|--|--|--|--------------------------|------|------|
| SCKp cycle time | t_{KCY1} | $t_{\text{KCY1}} \geq 4/f_{\text{CLK}}$ | $2.7\text{ V} \leq V_{DD} \leq 5.5\text{ V}$ | 250 | | ns |
| | | | $2.4\text{ V} \leq V_{DD} \leq 5.5\text{ V}$ | 500 | | ns |
| SCKp high-/low-level width | t_{KH1} , t_{KL1} | $4.0\text{ V} \leq V_{DD} \leq 5.5\text{ V}$ | | $t_{\text{KCY1}}/2 - 24$ | | ns |
| | | $2.7\text{ V} \leq V_{DD} \leq 5.5\text{ V}$ | | $t_{\text{KCY1}}/2 - 36$ | | ns |
| | | $2.4\text{ V} \leq V_{DD} \leq 5.5\text{ V}$ | | $t_{\text{KCY1}}/2 - 76$ | | ns |
| Slp setup time (to SCKp \uparrow) ^{Note 1} | t_{SIK1} | $4.0\text{ V} \leq V_{DD} \leq 5.5\text{ V}$ | | 66 | | ns |
| | | $2.7\text{ V} \leq V_{DD} \leq 5.5\text{ V}$ | | 66 | | ns |
| | | $2.4\text{ V} \leq V_{DD} \leq 5.5\text{ V}$ | | 113 | | ns |
| Slp hold time (from SCKp \uparrow) ^{Note 2} | t_{KSI1} | | 38 | | | ns |
| Delay time from SCKp \downarrow to SOp output ^{Note 3} | t_{KSO1} | $C = 30\text{ pF}$ ^{Note 4} | | | 50 | ns |

- Notes**
1. When $\text{DAPmn} = 0$ and $\text{CKPmn} = 0$, or $\text{DAPmn} = 1$ and $\text{CKPmn} = 1$. The Slp setup time becomes “to SCKp \downarrow ” when $\text{DAPmn} = 0$ and $\text{CKPmn} = 1$, or $\text{DAPmn} = 1$ and $\text{CKPmn} = 0$.
 2. When $\text{DAPmn} = 0$ and $\text{CKPmn} = 0$, or $\text{DAPmn} = 1$ and $\text{CKPmn} = 1$. The Slp hold time becomes “from SCKp \downarrow ” when $\text{DAPmn} = 0$ and $\text{CKPmn} = 1$, or $\text{DAPmn} = 1$ and $\text{CKPmn} = 0$.
 3. When $\text{DAPmn} = 0$ and $\text{CKPmn} = 0$, or $\text{DAPmn} = 1$ and $\text{CKPmn} = 1$. The delay time to SOp output becomes “from SCKp \uparrow ” when $\text{DAPmn} = 0$ and $\text{CKPmn} = 1$, or $\text{DAPmn} = 1$ and $\text{CKPmn} = 0$.
 4. C is the load capacitance of the SCKp and SOp output lines.

Caution Select the normal input buffer for the Slp pin and the normal output mode for the SOp pin and SCKp pin by using port input mode register g (PIMg) and port output mode register g (POMg).

- Remarks**
1. p: CSI number (p = 00, 01), m: Unit number (m = 0), n: Channel number (n = 0, 1),
g: PIM and POM numbers (g = 0, 3, 5, 7)
 2. f_{MCK} : Serial array unit operation clock frequency
(Operation clock to be set by the CKS $_{mn}$ bit of serial mode register mn (SMR $_{mn}$). m: Unit number,
n: Channel number (mn = 00, 01))

(3) During communication at same potential (CSI mode) (slave mode, SCKp... external clock input)
(T_A = -40 to +105°C, 2.4 V ≤ V_{DD} ≤ 5.5 V, V_{SS} = 0 V)

| Parameter | Symbol | Conditions | MIN. | TYP. | MAX. | Unit |
|--|--|-----------------------------------|---------------------------------|---------------------|-------------------------|------|
| SCKp cycle time ^{Note 5} | t _{KCY2} | 4.0 V ≤ V _{DD} ≤ 5.5 V | 20 MHz < f _{MCK} | 16/f _{MCK} | | ns |
| | | | f _{MCK} ≤ 20 MHz | 12/f _{MCK} | | ns |
| | | 2.7 V ≤ V _{DD} ≤ 5.5 V | 16 MHz < f _{MCK} | 16/f _{MCK} | | ns |
| | | | f _{MCK} ≤ 16 MHz | 12/f _{MCK} | | ns |
| | | 2.4 V ≤ V _{DD} ≤ 5.5 V | 12/f _{MCK} and 1000 | | ns | |
| SCKp high-/low-level width | t _{KH2} , t _{KL2} | 4.0 V ≤ EV _{DD0} ≤ 5.5 V | t _{KCY2} /2 – 14 | | | ns |
| | | 2.7 V ≤ EV _{DD0} ≤ 5.5 V | t _{KCY2} /2 – 16 | | | ns |
| | | 2.4 V ≤ V _{DD} ≤ 5.5 V | t _{KCY2} /2 – 36 | | | ns |
| Slp setup time (to SCKp↑) ^{Note 1} | t _{SIK2} | 2.7 V ≤ V _{DD} ≤ 5.5 V | 1/f _{MCK} +40 | | | ns |
| | | 2.4 V ≤ V _{DD} ≤ 5.5 V | 1/f _{MCK} +60 | | | ns |
| Slp hold time (from SCKp↑) ^{Note 2} | t _{KSI2} | 2.7 V ≤ V _{DD} ≤ 5.5 V | 1/f _{MCK} +62 | | | ns |
| | | 2.4 V ≤ V _{DD} ≤ 5.5 V | 1/f _{MCK} +62 | | | ns |
| Delay time from SCKp↓ to SOp output ^{Note 3} | t _{KSO2} | C = 30 pF ^{Note 4} | 2.7 V ≤ V _{DD} ≤ 5.5 V | | 2/f _{MCK} +66 | ns |
| | | | 2.4 V ≤ V _{DD} ≤ 5.5 V | | 2/f _{MCK} +113 | ns |

- Notes**
1. When DAP_{mn} = 0 and CKP_{mn} = 0, or DAP_{mn} = 1 and CKP_{mn} = 1. The Slp setup time becomes “to SCKp↓” when DAP_{mn} = 0 and CKP_{mn} = 1, or DAP_{mn} = 1 and CKP_{mn} = 0.
 2. When DAP_{mn} = 0 and CKP_{mn} = 0, or DAP_{mn} = 1 and CKP_{mn} = 1. The Slp hold time becomes “from SCKp↓” when DAP_{mn} = 0 and CKP_{mn} = 1, or DAP_{mn} = 1 and CKP_{mn} = 0.
 3. When DAP_{mn} = 0 and CKP_{mn} = 0, or DAP_{mn} = 1 and CKP_{mn} = 1. The delay time to SOp output becomes “from SCKp↑” when DAP_{mn} = 0 and CKP_{mn} = 1, or DAP_{mn} = 1 and CKP_{mn} = 0.
 4. C is the load capacitance of the SOp output lines.
 5. Transfer rate in the SNOOZE mode : MAX. 1 Mbps

Caution Select the normal input buffer for the Slp pin and SCKp pin and the normal output mode for the SOp pin by using port input mode register g (PIMg) and port output mode register g (POMg).

- Remarks**
1. p: CSI number (p = 00, 01), m: Unit number (m = 0),
n: Channel number (n = 0, 1), g: PIM number (g = 0, 3, 5, 7)
 2. f_{MCK}: Serial array unit operation clock frequency
(Operation clock to be set by the CKS_{mn} bit of serial mode register mn (SMR_{mn}). m: Unit number,
n: Channel number (mn = 00, 01))

CSI mode connection diagram (during communication at same potential)

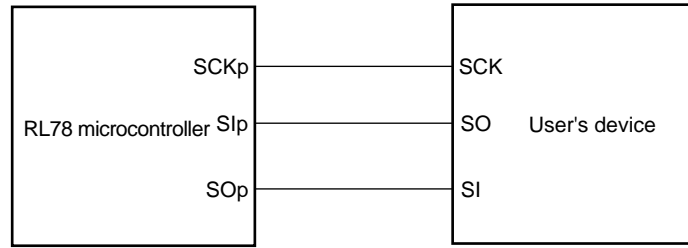

**CSI mode serial transfer timing (during communication at same potential)
(When DAPmn = 0 and CKPmn = 0, or DAPmn = 1 and CKPmn = 1.)**

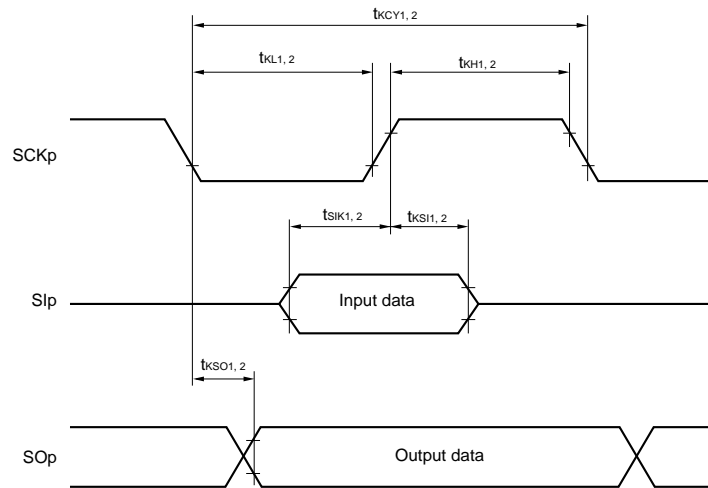

**CSI mode serial transfer timing (during communication at same potential)
(When DAPmn = 0 and CKPmn = 1, or DAPmn = 1 and CKPmn = 0.)**

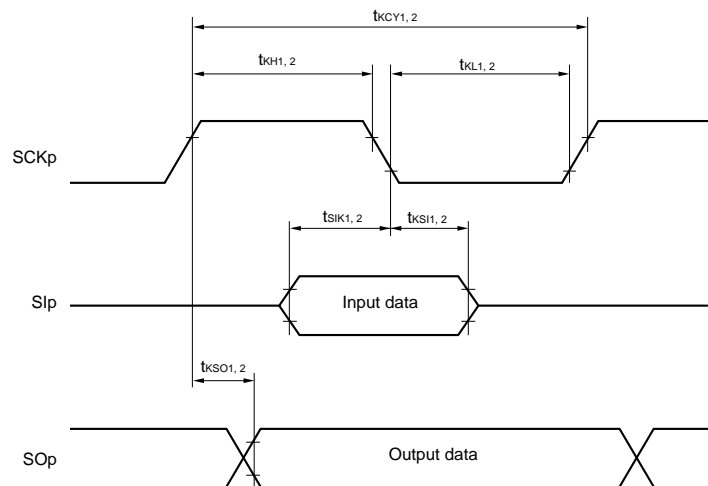

- Remarks**
1. p: CSI number (p = 00, 01)
 2. m: Unit number, n: Channel number (mn = 00, 01)

(4) During communication at same potential (simplified I²C mode)**(T_A = -40 to +105°C, 2.4 V ≤ V_{DD} ≤ 5.5 V, V_{SS} = 0 V)**

| Parameter | Symbol | Conditions | MIN. | MAX. | Unit |
|-------------------------------|---------------------|---|--------------------------|-----------------------|------|
| SCLr clock frequency | f _{SCL} | 2.7 V ≤ V _{DD} ≤ 5.5 V, C _b = 50 pF, R _b = 2.7 kΩ | | 400 ^{Note 1} | kHz |
| | | 2.4 V ≤ V _{DD} ≤ 5.5 V, C _b = 100 pF, R _b = 3 kΩ | | 100 ^{Note 1} | kHz |
| Hold time when SCLr = "L" | t _{LOW} | 2.7 V ≤ V _{DD} ≤ 5.5 V, C _b = 50 pF, R _b = 2.7 kΩ | 1200 | | ns |
| | | 2.4 V ≤ V _{DD} ≤ 5.5 V, C _b = 100 pF, R _b = 3 kΩ | 4600 | | ns |
| Hold time when SCLr = "H" | t _{HIGH} | 2.7 V ≤ V _{DD} ≤ 5.5 V, C _b = 50 pF, R _b = 2.7 kΩ | 1200 | | ns |
| | | 2.4 V ≤ V _{DD} ≤ 5.5 V, C _b = 100 pF, R _b = 3 kΩ | 4600 | | ns |
| Data setup time (reception) | t _{SU:DAT} | 2.7 V ≤ V _{DD} ≤ 5.5 V, C _b = 50 pF, R _b = 2.7 kΩ | 1/f _{MCK} + 220 | | ns |
| | | 2.4 V ≤ V _{DD} ≤ 5.5 V, C _b = 100 pF, R _b = 3 kΩ | 1/f _{MCK} + 580 | | ns |
| Data hold time (transmission) | t _{HD:DAT} | 2.7 V ≤ V _{DD} ≤ 5.5 V, C _b = 50 pF, R _b = 2.7 kΩ | 0 | 770 | ns |
| | | 2.4 V ≤ V _{DD} ≤ 5.5 V, C _b = 100 pF, R _b = 3 kΩ | 0 | 1420 | ns |

Notes 1. The value must also be equal to or less than f_{MCK}/4.

2. Set the f_{MCK} value to keep the hold time of SCLr = "L" and SCLr = "H".

Caution Select the normal input buffer and the N-ch open drain output (V_{DD} tolerance) mode for the SDAr pin and the normal output mode for the SCLr pin by using port input mode register g (PIMg) and port output mode register h (POMh).

(Caution and Remarks are listed on the next page.)

Simplified I²C mode connection diagram (during communication at same potential)

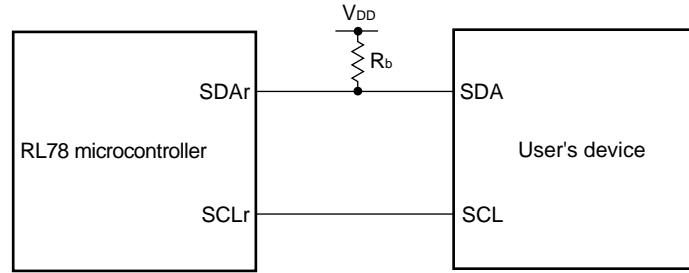

Simplified I²C mode serial transfer timing (during communication at same potential)

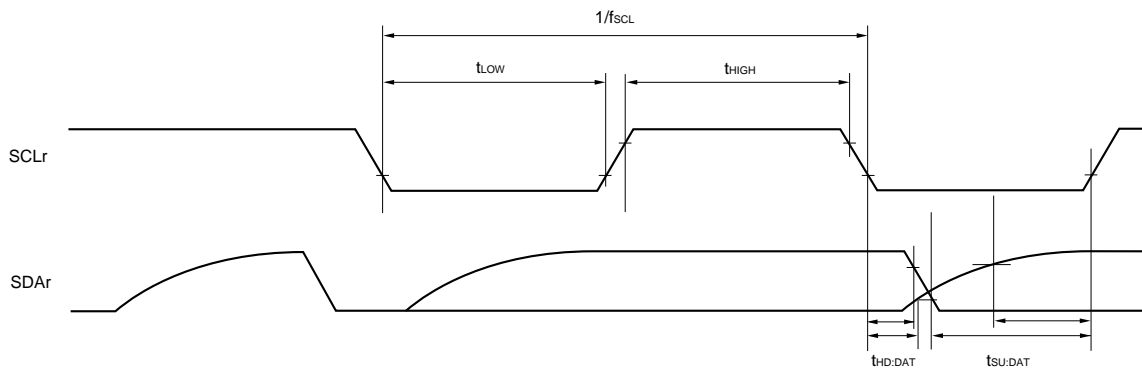

- Remarks**
1. R_b[Ω]:Communication line (SDAr) pull-up resistance, C_b[F]: Communication line (SDAr, SCLr) load capacitance
 2. r: IIC number (r = 00, 01), g: PIM number (g = 5), h: POM number (h = 3, 5)
 3. f_{MCK}: Serial array unit operation clock frequency
 (Operation clock to be set by the CKSmn bit of serial mode register mn (SMRmn). m: Unit number (m = 0), n: Channel number (n = 0, 1), mn = 00, 01)

(5) Communication at different potential (2.5 V, 3 V) (UART mode) (1/2)**(T_A = -40 to +105°C, 2.4 V ≤ V_{DD} ≤ 5.5 V, V_{SS} = 0 V)**

| Parameter | Symbol | Conditions | | MIN. | TYP. | MAX. | Unit | |
|---------------|--|--|--|--|------|--------------------------------|------|--|
| Transfer rate | | reception | 4.0 V ≤ V _{DD} ≤ 5.5 V, 2.7 V ≤ V _b ≤ 4.0 V | | | f _{MCK} /12 Note 1 | bps | |
| | | | | | | 2.0 | Mbps | |
| | | | | Theoretical value of the maximum transfer rate f _{CLK} = 24 MHz, f _{MCK} = f _{CLK} Note 2 | | | | |
| | | reception | 2.7 V ≤ V _{DD} < 4.0 V, 2.3 V ≤ V _b ≤ 2.7 V | | | f _{MCK} /12 Note 1 | bps | |
| | | | | | | 2.0 | Mbps | |
| | | | | Theoretical value of the maximum transfer rate f _{CLK} = 24 MHz, f _{MCK} = f _{CLK} Note 2 | | | | |
| reception | 2.4 V ≤ V _{DD} < 3.3 V, 1.6 V ≤ V _b ≤ 2.0 V | | | f _{MCK} /12 Note 1 | bps | | | |
| | | | | 2.0 | Mbps | | | |
| | | Theoretical value of the maximum transfer rate f _{CLK} = 24 MHz, f _{MCK} = f _{CLK} Note 2 | | | | | | |

Notes 1. Use it with V_{DD} ≥ V_b.**2.** The maximum operating frequencies of the CPU/peripheral hardware clock (f_{CLK}) are:

HS (high-speed main) mode: 24 MHz (2.7 V ≤ V_{DD} ≤ 5.5 V)
16 MHz (2.4 V ≤ V_{DD} ≤ 5.5 V)

Caution Select the TTL input buffer for the RxDq pin and the N-ch open drain output (V_{DD} tolerance) mode for the TxDq pin by using port input mode register g (PIMg) and port output mode register g (POMg). For V_{IH} and V_{IL}, see the DC characteristics with TTL input buffer selected

Remarks 1. V_b[V]: Communication line voltage**2.** q: UART number (q = 0), g: PIM and POM number (g = 5)**3.** f_{MCK}: Serial array unit operation clock frequency

(Operation clock to be set by the CKSmn bit of serial mode register mn (SMRmn). m: Unit number,
n: Channel number (mn = 00))

(5) Communication at different potential (2.5 V, 3 V) (UART mode) (2/2)**(T_A = -40 to +105°C, 2.4 V ≤ V_{DD} ≤ 5.5 V, V_{SS} = 0 V)**

| Parameter | Symbol | Conditions | MIN. | TYP. | MAX. | Unit | | |
|---------------|--------|--------------|---|--|---|---------------------------|-------------------|----------------------------|
| Transfer rate | | transmission | 4.0 V ≤ V _{DD} ≤ 5.5 V, 2.7 V ≤ V _b ≤ 4.0 V | | | Note 1 | bps | |
| | | | Theoretical value of the maximum transfer rate C _b = 50 pF, R _b = 1.4 kΩ, V _b = 2.7 V | | | 2.6 <small>Note 2</small> | Mbps | |
| | | | | 2.7 V ≤ V _{DD} < 4.0 V, 2.3 V ≤ V _b ≤ 2.7 V | | | Note 3 | bps |
| | | | | | Theoretical value of the maximum transfer rate C _b = 50 pF, R _b = 2.7 kΩ, V _b = 2.3 V | | | 1.2 <small>Note 4</small> |
| | | | | 2.4 V ≤ V _{DD} < 3.3 V, 1.6 V ≤ V _b ≤ 2.0 V | | | Notes 5, 6 | bps |
| | | | | | Theoretical value of the maximum transfer rate C _b = 50 pF, R _b = 5.5 kΩ, V _b = 1.6 V | | | 0.43 <small>Note 7</small> |

Notes 1. The smaller maximum transfer rate derived by using f_{MCK}/12 or the following expression is the valid maximum transfer rate.

Expression for calculating the transfer rate when 4.0 V ≤ V_{DD} ≤ 5.5 V and 2.7 V ≤ V_b ≤ 4.0 V

$$\text{Maximum transfer rate} = \frac{1}{\{-C_b \times R_b \times \ln(1 - \frac{2.2}{V_b})\} \times 3} \text{ [bps]}$$

$$\text{Baud rate error (theoretical value)} = \frac{\frac{1}{\text{Transfer rate} \times 2} - \{-C_b \times R_b \times \ln(1 - \frac{2.2}{V_b})\}}{(\frac{1}{\text{Transfer rate}}) \times \text{Number of transferred bits}} \times 100 \text{ [%]}$$

* This value is the theoretical value of the relative difference between the transmission and reception sides.

2. This value as an example is calculated when the conditions described in the “Conditions” column are met. Refer to Note 1 above to calculate the maximum transfer rate under conditions of the customer.

3. The smaller maximum transfer rate derived by using f_{MCK}/12 or the following expression is the valid maximum transfer rate.

Expression for calculating the transfer rate when 2.7 V ≤ V_{DD} < 4.0 V and 2.3 V ≤ V_b ≤ 2.7 V

$$\text{Maximum transfer rate} = \frac{1}{\{-C_b \times R_b \times \ln(1 - \frac{2.0}{V_b})\} \times 3} \text{ [bps]}$$

$$\text{Baud rate error (theoretical value)} = \frac{\frac{1}{\text{Transfer rate} \times 2} - \{-C_b \times R_b \times \ln(1 - \frac{2.0}{V_b})\}}{(\frac{1}{\text{Transfer rate}}) \times \text{Number of transferred bits}} \times 100 \text{ [%]}$$

* This value is the theoretical value of the relative difference between the transmission and reception sides.

4. This value as an example is calculated when the conditions described in the “Conditions” column are met. Refer to Note 3 above to calculate the maximum transfer rate under conditions of the customer.

5. Use it with V_{DD} ≥ V_b.

Notes 6. The smaller maximum transfer rate derived by using $f_{MCK}/12$ or the following expression is the valid maximum transfer rate.

Expression for calculating the transfer rate when $2.4\text{ V} \leq V_{DD} < 3.3\text{ V}$ and $1.6\text{ V} \leq V_b \leq 2.0\text{ V}$

$$\text{Maximum transfer rate} = \frac{1}{\{-C_b \times R_b \times \ln(1 - \frac{1.5}{V_b})\} \times 3} \text{ [bps]}$$

$$\text{Baud rate error (theoretical value)} = \frac{\frac{1}{\text{Transfer rate} \times 2} - \{-C_b \times R_b \times \ln(1 - \frac{1.5}{V_b})\}}{(\frac{1}{\text{Transfer rate}}) \times \text{Number of transferred bits}} \times 100 \text{ [%]}$$

* This value is the theoretical value of the relative difference between the transmission and reception sides.

7. This value as an example is calculated when the conditions described in the “Conditions” column are met. Refer to Note 6 above to calculate the maximum transfer rate under conditions of the customer.

Caution Select the TTL input buffer for the RxDq pin and the N-ch open drain output (V_{DD} tolerance) mode for the TxDq pin by using port input mode register g (PIMg) and port output mode register g (POMg). For V_{IH} and V_{IL}, see the DC characteristics with TTL input buffer selected

UART mode connection diagram (during communication at different potential)

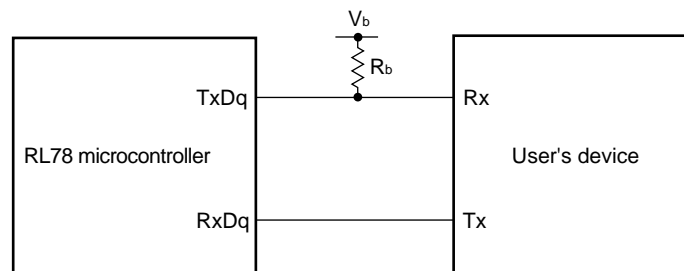

UART mode bit width (during communication at different potential) (reference)

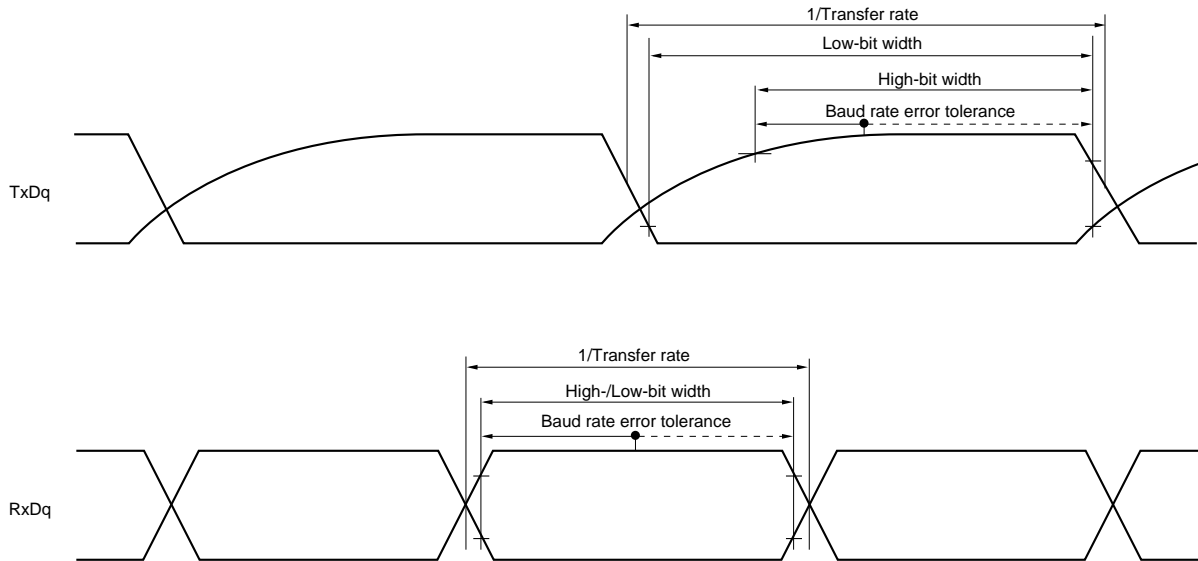

- Remarks 1.** $R_b[\Omega]$: Communication line (TxDq) pull-up resistance, $C_b[\text{F}]$: Communication line (TxDq) load capacitance, $V_b[\text{V}]$: Communication line voltage
- 2.** q: UART number (q = 0), g: PIM and POM number (g = 5)
- 3.** f_{MCK} : Serial array unit operation clock frequency
(Operation clock to be set by the CKSmn bit of serial mode register mn (SMRmn).
m: Unit number, n: Channel number (mn = 00))

(6) Communication at different potential (1.8 V, 2.5 V, 3 V) (CSI mode) (master mode, SCKp... internal clock output) (1/2)**(T_A = -40 to +105°C, 2.4 V ≤ V_{DD} ≤ 5.5 V, V_{SS} = 0 V)**

| Parameter | Symbol | Conditions | MIN. | TYP. | MAX. | Unit |
|-----------------------|-------------------|--|-------------------------------|------|------|------|
| SCKp cycle time | t _{KCY1} | t _{KCY1} ≥ 4/f _{CLK} 4.0 V ≤ V _{DD} ≤ 5.5 V, 2.7 V ≤ V _b ≤ 4.0 V, C _b = 30 pF, R _b = 1.4 kΩ | 600 | | | ns |
| | | 2.7 V ≤ V _{DD} < 4.0 V, 2.3 V ≤ V _b ≤ 2.7 V, C _b = 30 pF, R _b = 2.7 kΩ | 1000 | | | ns |
| | | 2.4 V ≤ V _{DD} < 3.3 V, 2.4 V ≤ V _b ≤ 2.0 V, C _b = 30 pF, R _b = 5.5 kΩ | 2300 | | | ns |
| SCKp high-level width | t _{KH1} | 4.0 V ≤ V _{DD} ≤ 5.5 V, 2.7 V ≤ V _b ≤ 4.0 V, C _b = 30 pF, R _b = 1.4 kΩ | t _{KCY1} /2 – 150 | | | ns |
| | | 2.7 V ≤ V _{DD} < 4.0 V, 2.3 V ≤ V _b ≤ 2.7 V, C _b = 30 pF, R _b = 2.7 kΩ | t _{KCY1} /2 – 340 | | | ns |
| | | 2.4 V ≤ V _{DD} < 3.3 V, 1.6 V ≤ V _b ≤ 2.0 V, C _b = 30 pF, R _b = 5.5 kΩ | t _{KCY1} /2 – 916 | | | ns |
| SCKp low-level width | t _{KL1} | 4.0 V ≤ V _{DD} ≤ 5.5 V, 2.7 V ≤ V _b ≤ 4.0 V, C _b = 30 pF, R _b = 1.4 kΩ | t _{KCY1} /2 – 24 | | | ns |
| | | 2.7 V ≤ V _{DD} < 4.0 V, 2.3 V ≤ V _b ≤ 2.7 V, C _b = 30 pF, R _b = 2.7 kΩ | t _{KCY1} /2 – 36 | | | ns |
| | | 2.4 V ≤ V _{DD} < 3.3 V, 1.6 V ≤ V _b ≤ 2.0 V, C _b = 30 pF, R _b = 5.5 kΩ | t _{KCY1} /2 – 100 | | | ns |

Cautions 1. Select the TTL input buffer for the Slp pin and the N-ch open drain output (V_{DD} tolerance) mode for the SOp pin and SCKp pin by using port input mode register g (PIMg) and port output mode register g (POMg). For V_{IH} and V_{IL}, see the DC characteristics with TTL input buffer selected.

2. Use it with V_{DD} ≥ V_b.

(Remarks are listed two pages after the next page.)

(6) Communication at different potential (1.8 V, 2.5 V, 3 V) (CSI mode) (master mode, SCKp... internal clock output)
(2/2)(T_A = -40 to +105°C, 2.4 V ≤ V_{DD} ≤ 5.5 V, V_{SS} = 0 V)

| Parameter | Symbol | Conditions | MIN. | TYP. | MAX. | Unit |
|--|-------------------|--|------|------|------|------|
| Slp setup time (to SCKp↑) ^{Note 1} | t _{SIK1} | 4.0 V ≤ V _{DD} ≤ 5.5 V, 2.7 V ≤ V _b ≤ 4.0 V, C _b = 30 pF, R _b = 1.4 kΩ | 162 | | | ns |
| | | 2.7 V ≤ V _{DD} < 4.0 V, 2.3 V ≤ V _b ≤ 2.7 V, C _b = 30 pF, R _b = 2.7 kΩ | 354 | | | ns |
| | | 2.4 V ≤ V _{DD} < 3.3 V, 1.6 V ≤ V _b ≤ 2.0 V ^{Note 3} , C _b = 30 pF, R _b = 5.5 kΩ | 958 | | | ns |
| Slp hold time (from SCKp↑) ^{Note 1} | t _{SIK1} | 4.0 V ≤ V _{DD} ≤ 5.5 V, 2.7 V ≤ V _b ≤ 4.0 V, C _b = 30 pF, R _b = 1.4 kΩ | 38 | | | ns |
| | | 2.7 V ≤ V _{DD} < 4.0 V, 2.3 V ≤ V _b ≤ 2.7 V, C _b = 30 pF, R _b = 2.7 kΩ | 38 | | | ns |
| | | 2.4 V ≤ V _{DD} < 3.3 V, 1.6 V ≤ V _b ≤ 2.0 V ^{Note 3} , C _b = 30 pF, R _b = 5.5 kΩ | 38 | | | ns |
| Delay time from SCKp↓ to SOP output ^{Note 1} | t _{KSO1} | 4.0 V ≤ V _{DD} ≤ 5.5 V, 2.7 V ≤ V _b ≤ 4.0 V, C _b = 30 pF, R _b = 1.4 kΩ | | | 200 | ns |
| | | 2.7 V ≤ V _{DD} < 4.0 V, 2.3 V ≤ V _b ≤ 2.7 V, C _b = 30 pF, R _b = 2.7 kΩ | | | 390 | ns |
| | | 2.4 V ≤ V _{DD} < 3.3 V, 1.6 V ≤ V _b ≤ 2.0 V ^{Note 3} , C _b = 30 pF, R _b = 5.5 kΩ | | | 966 | ns |
| Slp setup time (to SCKp↓) ^{Note 2} | t _{SIK1} | 4.0 V ≤ V _{DD} ≤ 5.5 V, 2.7 V ≤ V _b ≤ 4.0 V, C _b = 30 pF, R _b = 1.4 kΩ | 88 | | | ns |
| | | 2.7 V ≤ V _{DD} < 4.0 V, 2.3 V ≤ V _b ≤ 2.7 V, C _b = 30 pF, R _b = 2.7 kΩ | 88 | | | ns |
| | | 2.4 V ≤ V _{DD} < 3.3 V, 1.6 V ≤ V _b ≤ 2.0 V ^{Note 3} , C _b = 30 pF, R _b = 5.5 kΩ | 220 | | | ns |
| Slp hold time (from SCKp↓) ^{Note 2} | t _{SIK1} | 4.0 V ≤ V _{DD} ≤ 5.5 V, 2.7 V ≤ V _b ≤ 4.0 V, C _b = 30 pF, R _b = 1.4 kΩ | 38 | | | ns |
| | | 2.7 V ≤ V _{DD} < 4.0 V, 2.3 V ≤ V _b ≤ 2.7 V, C _b = 30 pF, R _b = 2.7 kΩ | 38 | | | ns |
| | | 2.4 V ≤ V _{DD} < 3.3 V, 1.6 V ≤ V _b ≤ 2.0 V ^{Note 3} , C _b = 30 pF, R _b = 5.5 kΩ | 38 | | | ns |
| Delay time from SCKp↑ to SOP output ^{Note 2} | t _{KSO1} | 4.0 V ≤ V _{DD} ≤ 5.5 V, 2.7 V ≤ V _b ≤ 4.0 V, C _b = 30 pF, R _b = 1.4 kΩ | | | 50 | ns |
| | | 2.7 V ≤ V _{DD} < 4.0 V, 2.3 V ≤ V _b ≤ 2.7 V, C _b = 30 pF, R _b = 2.7 kΩ | | | 50 | ns |
| | | 2.4 V ≤ V _{DD} < 3.3 V, 1.6 V ≤ V _b ≤ 2.0 V ^{Note 3} , C _b = 30 pF, R _b = 5.5 kΩ | | | 50 | ns |

(Notes, Cautions and Remarks are listed on the next page.)

- Notes**
1. When $\text{DAPmn} = 0$ and $\text{CKPmn} = 0$, or $\text{DAPmn} = 1$ and $\text{CKPmn} = 1$.
 2. When $\text{DAPmn} = 0$ and $\text{CKPmn} = 1$, or $\text{DAPmn} = 1$ and $\text{CKPmn} = 0$.
 - 3 Use it with $V_{\text{DD}} \geq V_b$.

Caution Select the TTL input buffer for the Slp pin and the N-ch open drain output (V_{DD} tolerance) mode for the SOp pin and SCKp pin by using port input mode register g (PIMg) and port output mode register g (POMg). For V_{IH} and V_{IL} , see the DC characteristics with TTL input buffer selected.

CSI mode connection diagram (during communication at different potential)

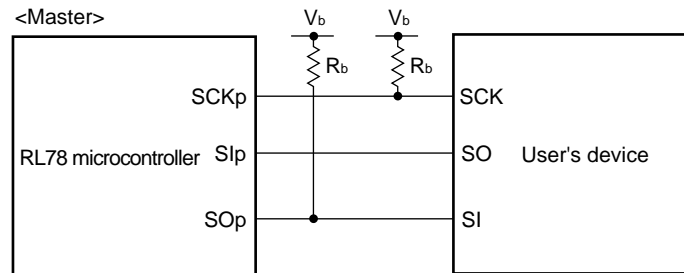

- Remarks**
1. $R_b[\Omega]$: Communication line (SCKp, SOp) pull-up resistance, $C_b[\text{F}]$: Communication line (SCKp, SOp) load capacitance, $V_b[\text{V}]$: Communication line voltage
 2. p: CSI number (p = 00), m: Unit number, n: Channel number (mn = 00), g: PIM and POM number (g = 0, 3, 5, 7)
 3. f_{MCK} : Serial array unit operation clock frequency
(Operation clock to be set by the CKSmn bit of serial mode register mn (SMRmn).
m: Unit number, n: Channel number (mn = 00))
 4. CSI01 cannot communicate at different potential. Use other CSI for communication at different potential.

**CSI mode serial transfer timing (master mode) (during communication at different potential)
(When DAPmn = 0 and CKPmn = 0, or DAPmn = 1 and CKPmn = 1.)**

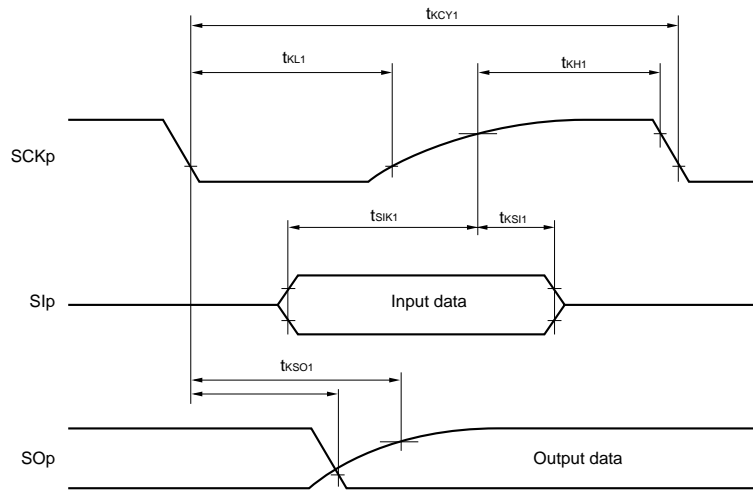

**CSI mode serial transfer timing (master mode) (during communication at different potential)
(When DAPmn = 0 and CKPmn = 1, or DAPmn = 1 and CKPmn = 0.)**

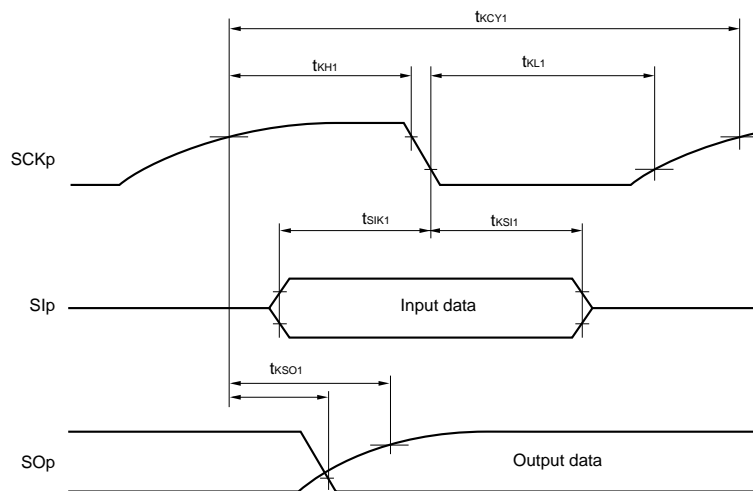

- Remarks**
1. p: CSI number (p = 00), m: Unit number, n: Channel number (mn = 00), g: PIM and POM number (g = 0, 3, 5, 7)
 2. CSI01 cannot communicate at different potential. Use other CSI for communication at different potential.

(7) Communication at different potential (1.8 V, 2.5 V, 3 V) (CSI mode) (slave mode, SCKp... external clock input)**(T_A = -40 to +105°C, 2.4 V ≤ V_{DD} ≤ 5.5 V, V_{SS} = 0 V)**

| Parameter | Symbol | Conditions | MIN. | TYP. | MAX. | Unit |
|---|--|--|------------------------------------|---------------------|---------------------------|------|
| SCKp cycle time ^{Note 1} | t _{KCY2} | 4.0 V ≤ V _{DD} ≤ 5.5 V, 2.7 V ≤ V _b ≤ 4.0 V | 20 MHz < f _{MCK} ≤ 24 MHz | 24/f _{MCK} | | ns |
| | | | 8 MHz < f _{MCK} ≤ 20 MHz | 20/f _{MCK} | | ns |
| | | | 4 MHz < f _{MCK} ≤ 8 MHz | 16/f _{MCK} | | ns |
| | | | f _{MCK} ≤ 4 MHz | 12/f _{MCK} | | ns |
| | | 2.7 V ≤ V _{DD} < 4.0 V, 2.3 V ≤ V _b ≤ 2.7 V | 20 MHz < f _{MCK} ≤ 24 MHz | 32/f _{MCK} | | ns |
| | | | 16 MHz < f _{MCK} ≤ 20 MHz | 28/f _{MCK} | | ns |
| | | | 8 MHz < f _{MCK} ≤ 16 MHz | 24/f _{MCK} | | ns |
| | | | 4 MHz < f _{MCK} ≤ 8 MHz | 16/f _{MCK} | | ns |
| | | 2.4 V ≤ V _{DD} < 3.3 V, 1.6 V ≤ V _b ≤ 2.0 V ^{Note 2} | 20 MHz < f _{MCK} ≤ 24 MHz | 72/f _{MCK} | | ns |
| | | | 16 MHz < f _{MCK} ≤ 20 MHz | 64/f _{MCK} | | ns |
| | | | 8 MHz < f _{MCK} ≤ 16 MHz | 52/f _{MCK} | | ns |
| | | | 4 MHz < f _{MCK} ≤ 8 MHz | 32/f _{MCK} | | ns |
| | | f _{MCK} ≤ 4 MHz | 20/f _{MCK} | | ns | |
| | | | | | | |
| | | | | | | |
| | | | | | | |
| SCKp high-/low-level width | t _{KH2} , t _{KL2} | 4.0 V ≤ V _{DD} ≤ 5.5 V, 2.7 V ≤ V _b ≤ 4.0 V | t _{KCY2} /2 – 24 | | | ns |
| | | 2.7 V ≤ V _{DD} < 4.0 V, 2.3 V ≤ V _b ≤ 2.7 V | t _{KCY2} /2 – 36 | | | ns |
| | | 2.4 V ≤ V _{DD} < 3.3 V, 1.6 V ≤ V _b ≤ 2.0 V ^{Note 2} | t _{KCY2} /2 – 100 | | | ns |
| Slp setup time (to SCKp↑) ^{Note 3} | t _{SIK2} | 4.0 V ≤ V _{DD} ≤ 5.5 V, 2.7 V ≤ V _b ≤ 4.0 V | 1/f _{MCK} + 40 | | | ns |
| | | 2.7 V ≤ V _{DD} < 4.0 V, 2.3 V ≤ V _b ≤ 2.7 V | 1/f _{MCK} + 40 | | | ns |
| | | 2.4 V ≤ V _{DD} < 3.3 V, 1.6 V ≤ V _b ≤ 2.0 V ^{Note 2} | 1/f _{MCK} + 60 | | | ns |
| Slp hold time (from SCKp↑) ^{Note 4} | t _{KS12} | | 1/f _{MCK} + 62 | | | ns |
| Delay time from SCKp↓ to SOp output ^{Note 5} | t _{KSO2} | 4.0 V ≤ V _{DD} ≤ 5.5 V, 2.7 V ≤ V _b ≤ 4.0 V, C _b = 30 pF, R _b = 1.4 kΩ | | | 2/f _{MCK} + 240 | ns |
| | | 2.7 V ≤ V _{DD} < 4.0 V, 2.3 V ≤ V _b ≤ 2.7 V, C _b = 30 pF, R _b = 2.7 kΩ | | | 2/f _{MCK} + 428 | ns |
| | | 2.4 V ≤ V _{DD} < 3.3 V, 1.6 V ≤ V _b ≤ 2.0 V ^{Note 2} , C _b = 30 pF, R _b = 5.5 kΩ | | | 2/f _{MCK} + 1146 | ns |

Notes 1. Transfer rate in the SNOOZE mode : MAX. 1 Mbps2. Use it with V_{DD} ≥ V_b.

3. When DAPmn = 0 and CKPmn = 0, or DAPmn = 1 and CKPmn = 1. The Slp setup time becomes “to SCKp↓” when DAPmn = 0 and CKPmn = 1, or DAPmn = 1 and CKPmn = 0.

4. When DAPmn = 0 and CKPmn = 0, or DAPmn = 1 and CKPmn = 1. The Slp hold time becomes “from SCKp↓” when DAPmn = 0 and CKPmn = 1, or DAPmn = 1 and CKPmn = 0.

5. When DAPmn = 0 and CKPmn = 0, or DAPmn = 1 and CKPmn = 1. The delay time to SOp output becomes “from SCKp↑” when DAPmn = 0 and CKPmn = 1, or DAPmn = 1 and CKPmn = 0.

(Caution and Remarks are listed on the next page.)

Caution Select the TTL input buffer for the SIp pin and SCKp pin and the N-ch open drain output (V_{DD} tolerance) mode for the SOp pin by using port input mode register g (PIMg) and port output mode register g (POMg). For V_{IH} and V_{IL} , see the DC characteristics with TTL input buffer selected.

CSI mode connection diagram (during communication at different potential)

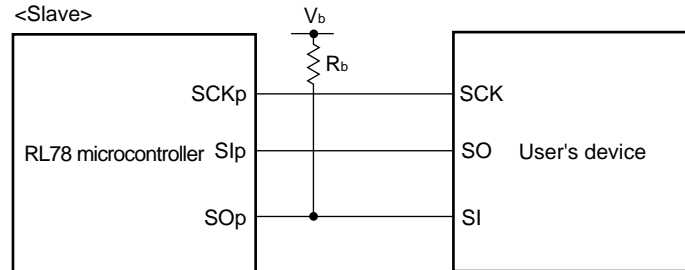

- Remarks**
1. $R_b[\Omega]$: Communication line (SOp) pull-up resistance, $C_b[\text{F}]$: Communication line (SOp) load capacitance, $V_b[\text{V}]$: Communication line voltage
 2. p: CSI number (p = 00), m: Unit number, n: Channel number (mn = 00), g: PIM and POM number (g = 0, 3, 5, 7)
 3. f_{MCK} : Serial array unit operation clock frequency
(Operation clock to be set by the CKSmn bit of serial mode register mn (SMRmn).
m: Unit number, n: Channel number (mn = 00))
 4. CSI01 cannot communicate at different potential. Use other CSI for communication at different potential.

CSI mode serial transfer timing (slave mode) (during communication at different potential)
(When DAPmn = 0 and CKPmn = 0, or DAPmn = 1 and CKPmn = 1.)

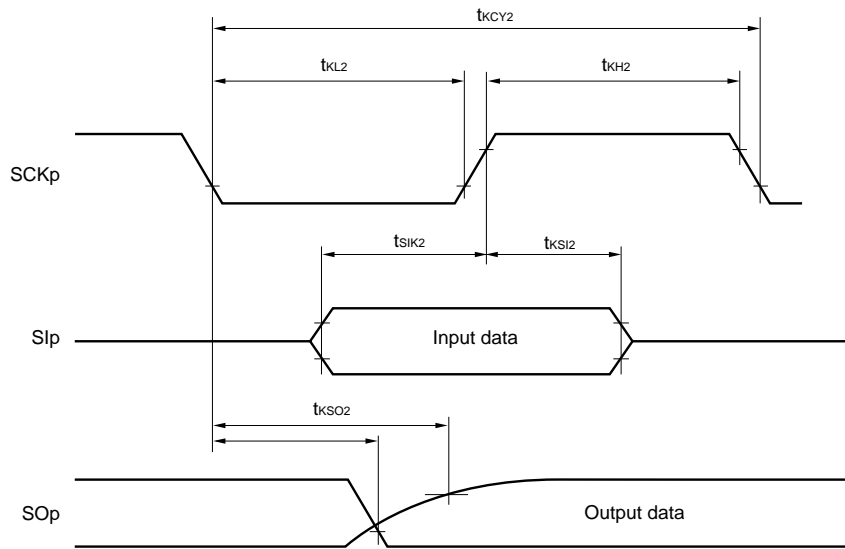

CSI mode serial transfer timing (slave mode) (during communication at different potential)
(When DAPmn = 0 and CKPmn = 1, or DAPmn = 1 and CKPmn = 0.)

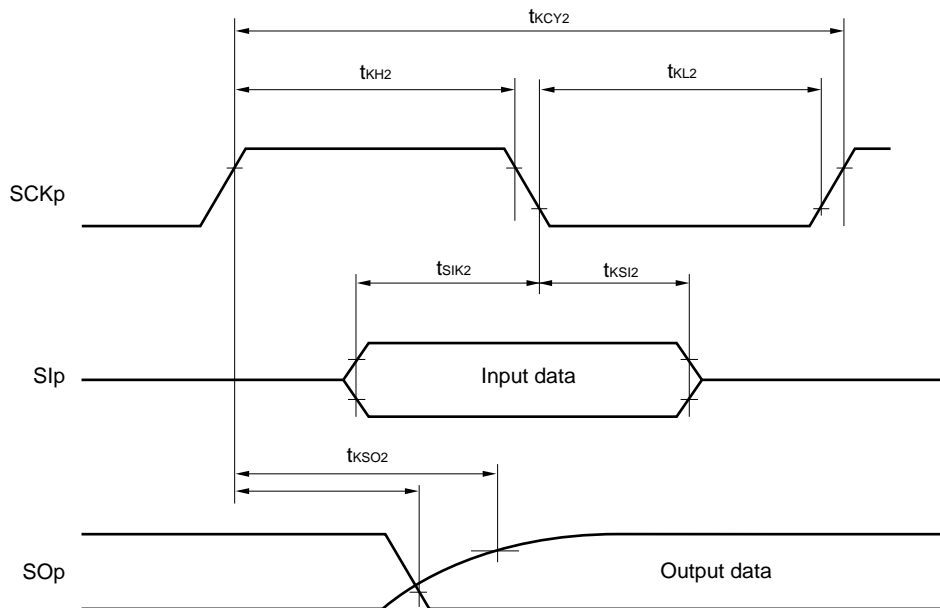

- Remarks 1.** p: CSI number (p = 00), m: Unit number, n: Channel number (mn = 00),
g: PIM and POM number (g = 0, 3, 5, 7)
- 2.** CSI01 cannot communicate at different potential. Use other CSI for communication at different potential.

(8) Communication at different potential (1.8 V, 2.5 V, 3 V) (simplified I²C mode) (1/2)
(T_A = -40 to +105°C, 2.4 V ≤ V_{DD} ≤ 5.5 V, V_{SS} = 0 V)

| Parameter | Symbol | Conditions | MIN. | MAX. | Unit |
|---------------------------|-------------------|--|------|-----------------------|------|
| SCLr clock frequency | f _{SCL} | 4.0 V ≤ V _{DD} ≤ 5.5 V, 2.7 V ≤ V _b ≤ 4.0 V, C _b = 50 pF, R _b = 2.7 kΩ | | 400 ^{Note 1} | kHz |
| | | 2.7 V ≤ V _{DD} < 4.0 V, 2.3 V ≤ V _b < 2.7 V, C _b = 50 pF, R _b = 2.7 kΩ | | 400 ^{Note 1} | kHz |
| | | 4.0 V ≤ V _{DD} ≤ 5.5 V, 2.7 V ≤ V _b ≤ 4.0 V, C _b = 100 pF, R _b = 2.8 kΩ | | 100 ^{Note 1} | kHz |
| | | 2.7 V ≤ V _{DD} < 4.0 V, 2.3 V ≤ V _b < 2.7 V, C _b = 100 pF, R _b = 2.7 kΩ | | 100 ^{Note 1} | kHz |
| | | 2.4 V ≤ V _{DD} < 3.3 V, 1.6 V ≤ V _b ≤ 2.0 V ^{Note 2} , C _b = 100 pF, R _b = 5.5 kΩ | | 100 ^{Note 1} | kHz |
| Hold time when SCLr = "L" | t _{LOW} | 4.0 V ≤ V _{DD} ≤ 5.5 V, 2.7 V ≤ V _b ≤ 4.0 V, C _b = 50 pF, R _b = 2.7 kΩ | 1200 | | ns |
| | | 2.7 V ≤ V _{DD} < 4.0 V, 2.3 V ≤ V _b < 2.7 V, C _b = 50 pF, R _b = 2.7 kΩ | 1200 | | ns |
| | | 4.0 V ≤ V _{DD} ≤ 5.5 V, 2.7 V ≤ V _b ≤ 4.0 V, C _b = 100 pF, R _b = 2.8 kΩ | 4600 | | ns |
| | | 2.7 V ≤ V _{DD} < 4.0 V, 2.3 V ≤ V _b < 2.7 V, C _b = 100 pF, R _b = 2.7 kΩ | 4600 | | ns |
| | | 2.4 V ≤ V _{DD} < 3.3 V, 1.6 V ≤ V _b ≤ 2.0 V ^{Note 2} , C _b = 100 pF, R _b = 5.5 kΩ | 4650 | | ns |
| Hold time when SCLr = "H" | t _{HIGH} | 4.0 V ≤ V _{DD} ≤ 5.5 V, 2.7 V ≤ V _b ≤ 4.0 V, C _b = 50 pF, R _b = 2.7 kΩ | 620 | | ns |
| | | 2.7 V ≤ V _{DD} < 4.0 V, 2.3 V ≤ V _b < 2.7 V, C _b = 50 pF, R _b = 2.7 kΩ | 500 | | ns |
| | | 4.0 V ≤ V _{DD} ≤ 5.5 V, 2.7 V ≤ V _b ≤ 4.0 V, C _b = 100 pF, R _b = 2.8 kΩ | 2700 | | ns |
| | | 2.7 V ≤ V _{DD} < 4.0 V, 2.3 V ≤ V _b < 2.7 V, C _b = 100 pF, R _b = 2.7 kΩ | 2400 | | ns |
| | | 2.4 V ≤ V _{DD} < 3.3 V, 1.6 V ≤ V _b ≤ 2.0 V ^{Note 2} , C _b = 100 pF, R _b = 5.5 kΩ | 1830 | | ns |

(Notes, Caution and Remarks are listed on the next page.)

(8) Communication at different potential (1.8 V, 2.5 V, 3 V) (simplified I²C mode) (2/2)**(T_A = -40 to +105°C, 2.4 V ≤ V_{DD} ≤ 5.5 V, V_{SS} = 0 V)**

| Parameter | Symbol | Conditions | MIN. | MAX. | Unit |
|-------------------------------|---------------------|--|---------------------------------------|------|------|
| Data setup time (reception) | t _{SU:DAT} | 4.0 V ≤ V _{DD} ≤ 5.5 V, 2.7 V ≤ V _b ≤ 4.0 V, C _b = 50 pF, R _b = 2.7 kΩ | 1/f _{MCK} + 340 Note 3 | | ns |
| | | 2.7 V ≤ V _{DD} < 4.0 V, 2.3 V ≤ V _b < 2.7 V, C _b = 50 pF, R _b = 2.7 kΩ | 1/f _{MCK} + 340 Note 3 | | ns |
| | | 4.0 V ≤ V _{DD} ≤ 5.5 V, 2.7 V ≤ V _b ≤ 4.0 V, C _b = 100 pF, R _b = 2.8 kΩ | 1/f _{MCK} + 760 Note 3 | | ns |
| | | 2.7 V ≤ V _{DD} < 4.0 V, 2.3 V ≤ V _b < 2.7 V, C _b = 100 pF, R _b = 2.7 kΩ | 1/f _{MCK} + 760 Note 3 | | ns |
| | | 2.4 V ≤ V _{DD} < 3.3 V, 1.6 V ≤ V _b ≤ 2.0 V ^{Notes 2,} C _b = 100 pF, R _b = 5.5 kΩ | 1/f _{MCK} + 570 Note 3 | | ns |
| Data hold time (transmission) | t _{HD:DAT} | 4.0 V ≤ V _{DD} ≤ 5.5 V, 2.7 V ≤ V _b ≤ 4.0 V, C _b = 50 pF, R _b = 2.7 kΩ | 0 | 770 | ns |
| | | 2.7 V ≤ V _{DD} < 4.0 V, 2.3 V ≤ V _b < 2.7 V, C _b = 50 pF, R _b = 2.7 kΩ | 0 | 770 | ns |
| | | 4.0 V ≤ V _{DD} ≤ 5.5 V, 2.7 V ≤ V _b ≤ 4.0 V, C _b = 100 pF, R _b = 2.8 kΩ | 0 | 1420 | ns |
| | | 2.7 V ≤ V _{DD} < 4.0 V, 2.3 V ≤ V _b < 2.7 V, C _b = 100 pF, R _b = 2.7 kΩ | 0 | 1420 | ns |
| | | 2.4 V ≤ V _{DD} < 3.3 V, 1.6 V ≤ V _b ≤ 2.0 V ^{Note 2,} C _b = 100 pF, R _b = 5.5 kΩ | 0 | 1215 | ns |

Notes 1. The value must also be equal to or less than f_{MCK}/4.**2.** Use it with V_{DD} ≥ V_b.**3.** Set the f_{MCK} value to keep the hold time of SCLr = "L" and SCLr = "H".

Caution Select the TTL input buffer and the N-ch open drain output (V_{DD} tolerance) mode for the SDAr pin and the N-ch open drain output (V_{DD} tolerance) mode for the SCLr pin by using port input mode register g (PIMg) and port output mode register g (POMg). For V_{IH} and V_{IL}, see the DC characteristics with TTL input buffer selected.

(Remarks are listed on the next page.)

Simplified I²C mode connection diagram (during communication at different potential)

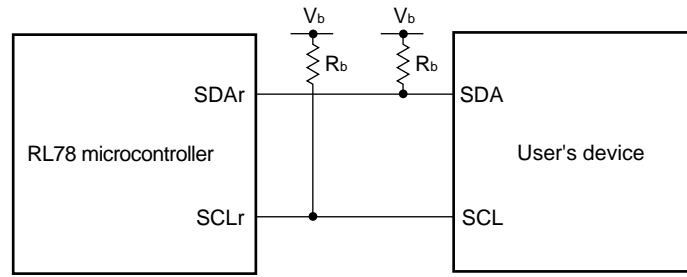

Simplified I²C mode serial transfer timing (during communication at different potential)

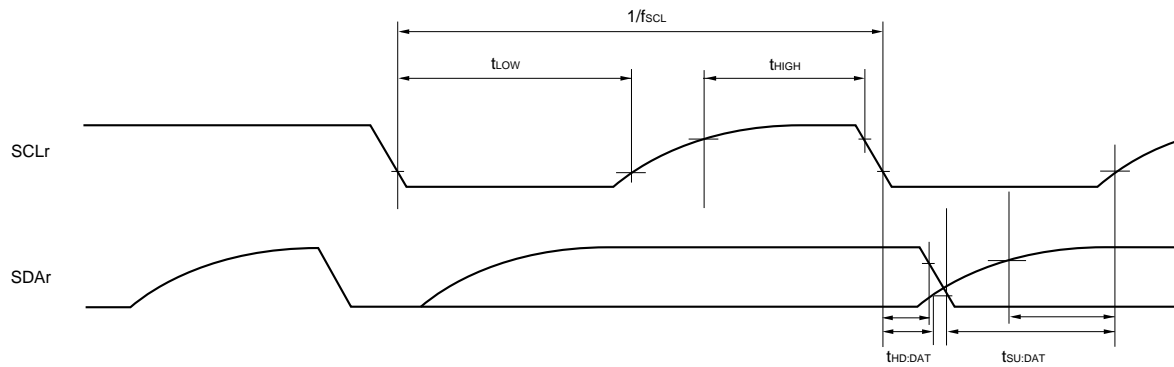

- Remarks**
1. $R_b[\Omega]$: Communication line (SDAr, SCLr) pull-up resistance, $C_b[F]$: Communication line (SDAr, SCLr) load capacitance, $V_b[V]$: Communication line voltage
 2. r: IIC number (r = 00), g: PIM, POM number (g = 0, 3, 5, 7)
 3. f_{MCK} : Serial array unit operation clock frequency
(Operation clock to be set by the CKSmn bit of serial mode register mn (SMRmn). m: Unit number, n: Channel number (mn = 00))

3.5.2 Serial interface IICA

(T_A = -40 to +105°C, 2.4 V ≤ V_{DD} ≤ 5.5 V, V_{SS} = 0 V)

| Parameter | Symbol | Conditions | HS (high-speed main) Mode | | | | Unit |
|---|---------------------|---|---------------------------|------|-----------|------|------|
| | | | Standard Mode | | Fast Mode | | |
| | | | MIN. | MAX. | MIN. | MAX. | |
| SCLA0 clock frequency | f _{SCL} | Fast mode: f _{CLK} ≥ 3.5 MHz | – | – | 0 | 400 | kHz |
| | | Standard mode: f _{CLK} ≥ 1 MHz | 0 | 100 | – | – | kHz |
| Setup time of restart condition | t _{SU:STA} | | 4.7 | | 0.6 | | μs |
| Hold time ^{Note 1} | t _{HD:STA} | | 4.0 | | 0.6 | | μs |
| Hold time when SCLA0 = "L" | t _{LOW} | | 4.7 | | 1.3 | | μs |
| Hold time when SCLA0 = "H" | t _{HIGH} | | 4.0 | | 0.6 | | μs |
| Data setup time (reception) | t _{SU:DAT} | | 250 | | 100 | | ns |
| Data hold time (transmission) ^{Note 2} | t _{HD:DAT} | | 0 | 3.45 | 0 | 0.9 | μs |
| Setup time of stop condition | t _{SU:STO} | | 4.0 | | 0.6 | | μs |
| Bus-free time | t _{BUF} | | 4.7 | | 1.3 | | μs |

- Notes**
- The first clock pulse is generated after this period when the start/restart condition is detected.
 - The maximum value (MAX.) of t_{HD:DAT} is during normal transfer and a wait state is inserted in the $\overline{\text{ACK}}$ (acknowledge) timing.

Caution The values in the above table are applied even when bit 1 (PIOR1) in the peripheral I/O redirection register (PIOR) is 1. At this time, the pin characteristics (I_{OH1}, I_{OL1}, V_{OH1}, V_{OL1}) must satisfy the values in the redirect destination.

Remark The maximum value of C_b (communication line capacitance) and the value of R_b (communication line pull-up resistor) at that time in each mode are as follows.

Standard mode: C_b = 400 pF, R_b = 2.7 kΩ

Fast mode: C_b = 320 pF, R_b = 1.1 kΩ

IICA serial transfer timing

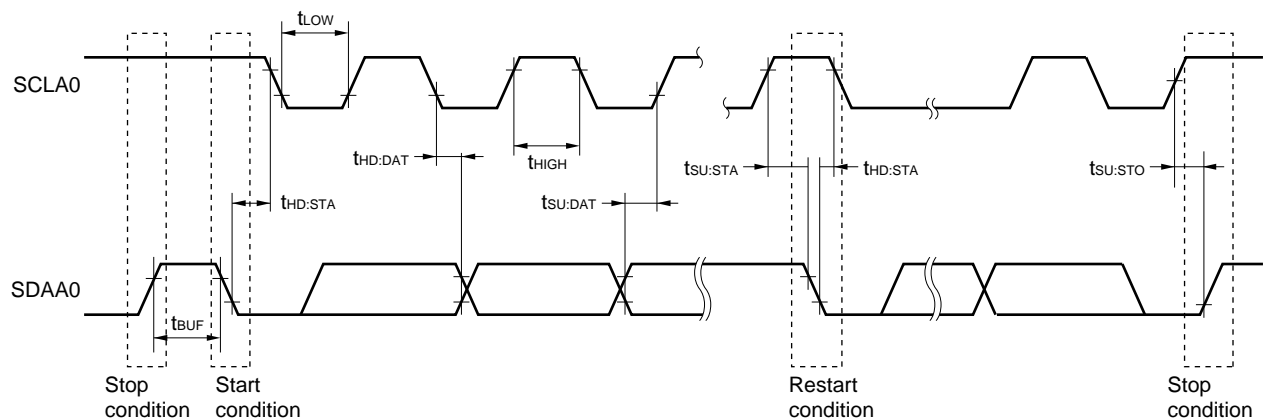

3.5.3 USB

(1) Electrical specifications

(T_A = -40 to +105°C, 3.0 V ≤ UV_{DD} ≤ 3.6 V, 3.0 V ≤ V_{DD} ≤ 5.5 V, V_{SS} = 0 V)

| Parameter | | Symbol | Conditions | MIN. | TYP. | MAX. | Unit |
|-------------------|--|-------------------|---|---------------------------------|------|------|------|
| UV _{DD} | UV _{DD} input voltage characteristic | UV _{DD} | V _{DD} = 3.0 to 5.5 V, PXXCON = 1, VDDUSEB = 0 (UV _{DD} ≤ V _{DD}) | 3.0 | 3.3 | 3.6 | V |
| | UV _{DD} output voltage characteristic | UV _{DD} | V _{DD} = 4.0 to 5.5 V, PXXCON = VDDUSEB = 1 | 3.0 | 3.3 | 3.6 | V |
| UV _{BUS} | UV _{BUS} input voltage characteristic | UV _{BUS} | Function | 4.35 (4.02 ^{Note}) | 5.00 | 5.25 | V |
| | | | Host | 4.75 | 5.00 | 5.25 | V |

Note Value of instantaneous voltage(T_A = -40 to +105°C, 3.0 V ≤ UV_{DD} ≤ 3.6 V, 3.0 V ≤ V_{DD} ≤ 5.5 V, V_{SS} = 0 V)

| Parameter | | Symbol | Conditions | MIN. | TYP. | MAX. | Unit | |
|--|--------------------------------------|---|-----------------------------------|---|------|-------|------|----|
| UDPi/UDMi pins input characteristic (FS/LS receiver) | Input voltage | V _{IH} | | 2.0 | | | V | |
| | | V _{IL} | | | | 0.8 | V | |
| | Difference input sensitivity | V _{DI} | UDP voltage – UDM voltage | 0.2 | | | V | |
| | Difference common mode range | V _{CM} | | 0.8 | | 2.5 | V | |
| UDPi/UDMi pins output characteristic (FS driver) | Output voltage | V _{OH} | I _{OH} = -200 μA | 2.8 | | 3.6 | V | |
| | | V _{OL} | I _{OL} = 2.4 mA | 0 | | 0.3 | V | |
| | Transi-ti on time | Rising | t _{FR} | Rising: From 10% to 90 % of amplitude, | 4 | | 20 | ns |
| | | Falling | t _{FF} | Falling: From 90% to 10 % of amplitude, | 4 | | 20 | ns |
| | Matching (TFR/TFF) | V _{FRFM} | CL = 50 pF | 90 | | 111.1 | % | |
| | Crossover voltage | V _{FCRS} | | 1.3 | | 2.0 | V | |
| Output Impedance | Z _{DRV} | UV _{DD} voltage = 3.3 V, Pin voltage = 1.65 V | 28 | | 44 | Ω | | |
| UDPi/UDMi pins output characteristic (LS driver) | Output voltage | V _{OH} | | 2.8 | | 3.6 | V | |
| | | V _{OL} | | 0 | | 0.3 | V | |
| | Transi-ti on time | Rising | t _{LR} | Rising: From 10% to 90 % of amplitude, | 75 | | 300 | ns |
| | | Falling | t _{LF} | Falling: From 90% to 10 % of amplitude, | 75 | | 300 | ns |
| | Matching (TFR/TFF) Note | V _{LTFM} | CL = 200 to 600 pF | 80 | | 125 | % | |
| Crossover voltage Note | V _{LCRS} | When the host controller function is selected: The UDMi pin (i = 0, 1) is pulled up via 1.5 kΩ. When the function controller function is selected: The UDP0 and UDM0 pins are individually pulled down via 15 kΩ | 1.3 | | 2.0 | V | | |
| UDPi/UDMi pins pull-up, pull-down | Pull-down resistor | R _{PD} | | 14.25 | | 24.80 | kΩ | |
| | Pull-up resistor (i = 0 only) | Idle | R _{PUI} | 0.9 | | 1.575 | kΩ | |
| | | Reception | R _{PUA} | 1.425 | | 3.09 | kΩ | |
| UV _{BUS} | UV _{BUS} pull-down resistor | R _{VBUS} | UV _{BUS} voltage = 5.5 V | | 1000 | | kΩ | |
| | UV _{BUS} input voltage | V _{IH} | | 3.20 | | | V | |
| | | V _{IL} | | | | 0.8 | V | |

Note Excludes the first signal transition from the idle state.**Remark** i = 0, 1

Timing of UDPi and UDMi

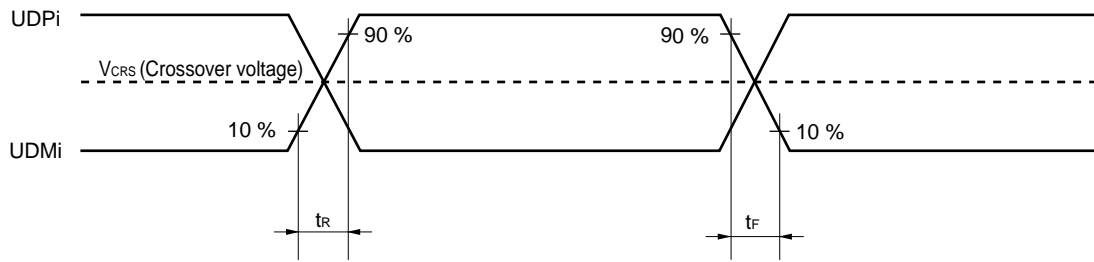

(2) BC standard

($T_A = -40$ to $+105^{\circ}\text{C}$, $3.0\text{ V} \leq UV_{DD} \leq 3.6\text{ V}$, $3.0\text{ V} \leq V_{DD} \leq 5.5\text{ V}$, $V_{SS} = 0\text{ V}$)

| | Parameter | Symbol | Conditions | MIN. | TYP. | MAX. | Unit |
|--------------------|----------------------------------|----------------|--|------|------|------|---------------|
| USB standard BC1.2 | UDPi sink current | I_{DP_SINK} | | 25 | | 175 | μA |
| | UDMi sink current | I_{DM_SINK} | | 25 | | 175 | μA |
| | DCD source current | I_{DP_SRC} | | 7 | | 13 | μA |
| | Dedicated charging port resistor | R_{DCP_DAT} | $0\text{ V} < \text{UDP/UDM voltage} < 1.0\text{ V}$ | | | 200 | Ω |
| | Data detection voltage | V_{DAT_REF} | | 0.25 | | 0.4 | V |
| | UDPi source voltage | V_{DP_SRC} | Output current $250\ \mu\text{A}$ | 0.5 | | 0.7 | V |
| | UDMi source voltage | V_{DM_SRC} | Output current $250\ \mu\text{A}$ | 0.5 | | 0.7 | V |

Remark $i = 0, 1$

(3) BC option standard (Host)**(T_A = -40 to +105°C, 4.75 V ≤ UV_{BUS} ≤ 5.25 V, 3.0 V ≤ UV_{DD} ≤ 3.6 V, 2.4 V ≤ V_{DD} ≤ 5.5 V, V_{SS} = 0 V)**

| Parameter | | Symbol | Conditions | MIN. | TYP. | MAX. | Unit | |
|---|-------------------------|--------|-------------------------|--|------|------|-------|---------------------|
| UDPi output voltage (UV _{BUS} divider ratio) • VDOUEi = 1 | VDSELi [3:0] (i = 0, 1) | 1000 | V _{P20} | | 38 | 40 | 42 | % UV _{BUS} |
| | | 1001 | V _{P27} | | 51.6 | 53.6 | 55.6 | % UV _{BUS} |
| | | 1010 | V _{P20} | | 38 | 40 | 42 | % UV _{BUS} |
| | | 1100 | V _{P33} | | 60 | 66 | 72 | % UV _{BUS} |
| UDMi output voltage (UV _{BUS} divider ratio) • VDOUEi = 1 | VDSELi [3:0] (i = 0, 1) | 1000 | V _{M20} | | 38 | 40 | 42 | % UV _{BUS} |
| | | 1001 | V _{M20} | | 38 | 40 | 42 | % UV _{BUS} |
| | | 1010 | V _{M27} | | 51.6 | 53.6 | 55.6 | % UV _{BUS} |
| | | 1100 | V _{M33} | | 60 | 66 | 72 | % UV _{BUS} |
| UDPi comparing voltage Note 1 (UV _{BUS} divider ratio) • VDOUEi = 1 • CUSDETEi = 1 | VDSELi [3:0] (i = 0, 1) | 1000 | V _{HDETP_UP0} | The rise of pin voltage detection voltage | 56.2 | | | % UV _{BUS} |
| | | | V _{HDETP_DWN0} | The fall of pin voltage detection voltage | | | 29.4 | % UV _{BUS} |
| | | 1001 | V _{HDETP_UP1} | The rise of pin voltage detection voltage | 60.5 | | | % UV _{BUS} |
| | | | V _{HDETP_DWN1} | The fall of pin voltage detection voltage | | | 45.0 | % UV _{BUS} |
| | | 1010 | V _{HDETP_UP2} | The rise of pin voltage detection voltage | 56.2 | | | % UV _{BUS} |
| | | | V _{HDETP_DWN2} | The fall of pin voltage detection voltage | | | 29.4 | % UV _{BUS} |
| UDMi comparing voltage Note 1 (UV _{BUS} divider ratio) • VDOUEi = 1 • CUSDETEi = 1 | VDSELi [3:0] (i = 0, 1) | 1000 | V _{HDETM_UP0} | The rise of pin voltage detection voltage | 56.2 | | | % UV _{BUS} |
| | | | V _{HDETM_DWN0} | The fall of pin voltage detection voltage | | | 29.4 | % UV _{BUS} |
| | | 1001 | V _{HDETM_UP1} | The rise of pin voltage detection voltage | 56.2 | | | % UV _{BUS} |
| | | | V _{HDETM_DWN1} | The fall of pin voltage detection voltage | | | 29.4 | % UV _{BUS} |
| | | 1010 | V _{HDETM_UP2} | The rise of pin voltage detection voltage | 60.5 | | | % UV _{BUS} |
| | | | V _{HDETM_DWN2} | The fall of pin voltage detection voltage | | | 45.0 | % UV _{BUS} |
| UDPi pull-up detection Note 2 Connect detection with the full speed function (pull-up resistor) | | 1000 | R _{HDET_PULL} | In full-speed mode, the power supply voltage range of pull-up resistors connected to the USB function module is between 3.0 V and 3.6 V. | | | 1.575 | kΩ |
| | | 1001 | | | | | | |
| | | 1010 | | | | | | |
| UDMi pull-up detection Note 2 Connect detection with the low-speed (pull-up resistor) | | 1000 | R _{HDET_PULL} | In low-speed mode, the power supply voltage range of pull-up resistors connected to the USB function module is between 3.0 V and 3.6 V. | | | 1.575 | kΩ |
| | | 1001 | | | | | | |
| | | 1010 | | | | | | |
| UDMi sink current detection Note 2 Connect detection with the BC1.2 portable device (sink resistor) | | 1000 | I _{HDET_SINK} | | 25 | | | μA |
| | | 1001 | | | | | | |
| | | 1010 | | | | | | |

Notes 1. If the voltage output from UDPi or UDMi (i = 0, 1) exceeds the range of the MAX and MIN values prescribed in this specification, DPCUSDETi (bit 8) and DMCUSDETi (bit 9) of the USBBCOPTi register are set to 1.

2. If the pull-up resistance or sink current prescribed in this specification is applied to UDPi or UDMi (i = 0, 1), DPCUSDETi (bit 8) and DMCUSDETi (bit 9) of the USBBCOPTi register are set to 1.

Remark i = 0, 1

(4) BC option standard (Function)**($T_A = -40$ to $+105^\circ\text{C}$, $4.35\text{ V} \leq UV_{BUS} \leq 5.25\text{ V}$, $3.0\text{ V} \leq UV_{DD} \leq 3.6\text{ V}$, $2.4\text{ V} \leq V_{DD} \leq 5.5\text{ V}$, $V_{SS} = 0\text{ V}$)**

| Parameter | | Symbol | Conditions | MIN. | TYP. | MAX. | Unit | |
|--|--------------------------------|--------|--------------|------|------|------|------|--------------|
| UDPi/UDMi input reference voltage (UV_{BUS} divider ratio) • $VDOUE_i = 0$ ($i = 0$) | VDSELi [3:0] ($i = 0$) | 0000 | V_{DDET0} | | 27 | 32 | 37 | % UV_{BUS} |
| | | 0001 | V_{DDET1} | | 29 | 34 | 39 | % UV_{BUS} |
| | | 0010 | V_{DDET2} | | 32 | 37 | 42 | % UV_{BUS} |
| | | 0011 | V_{DDET3} | | 35 | 40 | 45 | % UV_{BUS} |
| | | 0100 | V_{DDET4} | | 38 | 43 | 48 | % UV_{BUS} |
| | | 0101 | V_{DDET5} | | 41 | 46 | 51 | % UV_{BUS} |
| | | 0110 | V_{DDET6} | | 44 | 49 | 54 | % UV_{BUS} |
| | | 0111 | V_{DDET7} | | 47 | 52 | 57 | % UV_{BUS} |
| | | 1000 | V_{DDET8} | | 51 | 56 | 61 | % UV_{BUS} |
| | | 1001 | V_{DDET9} | | 55 | 60 | 65 | % UV_{BUS} |
| | | 1010 | V_{DDET10} | | 59 | 64 | 69 | % UV_{BUS} |
| | | 1011 | V_{DDET11} | | 63 | 68 | 73 | % UV_{BUS} |
| | | 1100 | V_{DDET12} | | 67 | 72 | 77 | % UV_{BUS} |
| | | 1101 | V_{DDET13} | | 71 | 76 | 81 | % UV_{BUS} |
| | | 1110 | V_{DDET14} | | 75 | 80 | 85 | % UV_{BUS} |
| | | 1111 | V_{DDET15} | | 79 | 84 | 89 | % UV_{BUS} |

3.6 Analog Characteristics

3.6.1 A/D converter characteristics

Classification of A/D converter characteristics

| Input channel | Reference Voltage | | |
|--|--|--|--|
| | Reference voltage (+) = AV _{REFP} Reference voltage (-) = AV _{REFM} | Reference voltage (+) = V _{DD} Reference voltage (-) = V _{SS} | Reference voltage (+) = V _{BGR} Reference voltage (-) = AV _{REFM} |
| ANI0 to ANI7 | Refer to 3.6.1 (1). | Refer to 3.6.1 (3). | Refer to 3.6.1 (4). |
| ANI16, ANI17, ANI19 | Refer to 3.6.1 (2). | | |
| Internal reference voltage Temperature sensor output voltage | Refer to 3.6.1 (1). | | – |

(1) When AV_{REF(+)} = AV_{REFP}/ANI0 (ADREFP1 = 0, ADREFP0 = 1), reference voltage (-) = AV_{REFM}/ANI1 (ADREFM = 1), target pin : ANI2 to ANI7, internal reference voltage, and temperature sensor output voltage

(T_A = -40 to +105°C, 2.4 V ≤ AV_{REFP} ≤ V_{DD} ≤ 5.5 V, V_{SS} = 0 V, Reference voltage (+) = AV_{REFP}, Reference voltage (-) = AV_{REFM} = 0 V)

| Parameter | Symbol | Conditions | | MIN. | TYP. | MAX. | Unit |
|--|-------------------|--|------------------------------------|---------------------------------------|------|--------------------|------|
| Resolution | R _{ES} | | | 8 | | 10 | bit |
| Overall error ^{Note 1} | AINL | 10-bit resolution AV _{REFP} = V _{DD} ^{Note 3} | 2.4 V ≤ AV _{REFP} ≤ 5.5 V | | 1.2 | ±3.5 | LSB |
| Conversion time | t _{CONV} | 10-bit resolution Target pin: ANI2 to ANI7 | 3.6 V ≤ V _{DD} ≤ 5.5 V | 2.125 | | 39 | μs |
| | | | 2.7 V ≤ V _{DD} ≤ 5.5 V | 3.1875 | | 39 | μs |
| | | | 2.4 V ≤ V _{DD} ≤ 5.5 V | 17 | | 39 | μs |
| | | 10-bit resolution Target pin: Internal reference voltage, and temperature sensor output voltage (HS (high-speed main) mode) | 3.6 V ≤ V _{DD} ≤ 5.5 V | 2.375 | | 39 | μs |
| | | | 2.7 V ≤ V _{DD} ≤ 5.5 V | 3.5625 | | 39 | μs |
| | | | 2.4 V ≤ V _{DD} ≤ 5.5 V | 17 | | 39 | μs |
| Zero-scale error ^{Notes 1, 2} | EZS | 10-bit resolution AV _{REFP} = V _{DD} ^{Note 3} | 2.4 V ≤ AV _{REFP} ≤ 5.5 V | | | ±0.25 | %FSR |
| Full-scale error ^{Notes 1, 2} | EFS | 10-bit resolution AV _{REFP} = V _{DD} ^{Note 3} | 2.4 V ≤ AV _{REFP} ≤ 5.5 V | | | ±0.25 | %FSR |
| Integral linearity error ^{Note 1} | ILE | 10-bit resolution AV _{REFP} = V _{DD} ^{Note 3} | 2.4 V ≤ AV _{REFP} ≤ 5.5 V | | | ±2.5 | LSB |
| Differential linearity error ^{Note 1} | DLE | 10-bit resolution AV _{REFP} = V _{DD} ^{Note 3} | 2.4 V ≤ AV _{REFP} ≤ 5.5 V | | | ±1.5 | LSB |
| Analog input voltage | V _{AIN} | ANI2 to ANI7 | | 0 | | AV _{REFP} | V |
| | | Internal reference voltage (2.4 V ≤ V _{DD} ≤ 5.5 V, HS (high-speed main) mode) | | V _{BGR} ^{Note 4} | | | V |
| | | Temperature sensor output voltage (2.4 V ≤ V _{DD} ≤ 5.5 V, HS (high-speed main) mode) | | V _{TMPS25} ^{Note 4} | | | V |

(Notes are listed on the next page.)

- Notes**
1. Excludes quantization error ($\pm 1/2$ LSB).
 2. This value is indicated as a ratio (%FSR) to the full-scale value.
 3. When $AV_{REFP} < V_{DD}$, the MAX. values are as follows.
Overall error: Add ± 1.0 LSB to the MAX. value when $AV_{REFP} = V_{DD}$.
Zero-scale error/Full-scale error: Add $\pm 0.05\%$ FSR to the MAX. value when $AV_{REFP} = V_{DD}$.
Integral linearity error/ Differential linearity error: Add ± 0.5 LSB to the MAX. value when $AV_{REFP} = V_{DD}$.
 4. Refer to **3.6.2 Temperature sensor/internal reference voltage characteristics**.

(2) When reference voltage (+) = $AV_{REFP}/ANI0$ ($ADREFP1 = 0$, $ADREFP0 = 1$), reference voltage (-) = $AV_{REFM}/ANI1$ ($ADREFM = 1$), target pin : ANI16, ANI17, ANI19

($T_A = -40$ to $+105^\circ\text{C}$, $2.4\text{ V} \leq AV_{REFP} \leq V_{DD} \leq 5.5\text{ V}$, $V_{SS} = 0\text{ V}$, Reference voltage (+) = AV_{REFP} , Reference voltage (-) = $AV_{REFM} = 0\text{ V}$)

| Parameter | Symbol | Conditions | MIN. | TYP. | MAX. | Unit |
|--|------------|--|---|--------|-----------------------------|---------------|
| Resolution | R_{ES} | | 8 | | 10 | bit |
| Overall error ^{Note 1} | A_{INL} | 10-bit resolution $AV_{REFP} = V_{DD}$ ^{Note 3} | $2.4\text{ V} \leq AV_{REFP} \leq 5.5\text{ V}$ | 1.2 | ± 5.0 | LSB |
| Conversion time | t_{CONV} | 10-bit resolution Target ANI pin : ANI16, ANI17, ANI19 | $3.6\text{ V} \leq V_{DD} \leq 5.5\text{ V}$ | 2.125 | 39 | μs |
| | | | $2.7\text{ V} \leq V_{DD} \leq 5.5\text{ V}$ | 3.1875 | 39 | μs |
| | | | $2.4\text{ V} \leq V_{DD} \leq 5.5\text{ V}$ | 17 | 39 | μs |
| Zero-scale error ^{Notes 1, 2} | E_{ZS} | 10-bit resolution $AV_{REFP} = V_{DD}$ ^{Note 3} | $2.4\text{ V} \leq AV_{REFP} \leq 5.5\text{ V}$ | | ± 0.35 | %FSR |
| Full-scale error ^{Notes 1, 2} | E_{FS} | 10-bit resolution $AV_{REFP} = V_{DD}$ ^{Note 3} | $2.4\text{ V} \leq AV_{REFP} \leq 5.5\text{ V}$ | | ± 0.35 | %FSR |
| Integral linearity error ^{Note 1} | I_{LE} | 10-bit resolution $AV_{REFP} = V_{DD}$ ^{Note 3} | $2.4\text{ V} \leq AV_{REFP} \leq 5.5\text{ V}$ | | ± 3.5 | LSB |
| Differential linearity error ^{Note 1} | D_{LE} | 10-bit resolution $AV_{REFP} = V_{DD}$ ^{Note 3} | $2.4\text{ V} \leq AV_{REFP} \leq 5.5\text{ V}$ | | ± 2.0 | LSB |
| Analog input voltage | V_{AIN} | ANI16, ANI17, ANI19 | 0 | | AV_{REFP} and V_{DD} | V |

Notes 1. Excludes quantization error ($\pm 1/2$ LSB).

2. This value is indicated as a ratio (%FSR) to the full-scale value.

3. When $AV_{REFP} < V_{DD}$, the MAX. values are as follows.

Overall error: Add ± 4.0 LSB to the MAX. value when $AV_{REFP} = V_{DD}$.

Zero-scale error/Full-scale error: Add $\pm 0.20\%$ FSR to the MAX. value when $AV_{REFP} = V_{DD}$.

Integral linearity error/ Differential linearity error: Add ± 2.0 LSB to the MAX. value when $AV_{REFP} = V_{DD}$.

(3) Reference voltage (+) = V_{DD} (ADREFF1 = 0, ADREFF0 = 0), Reference voltage (-) = V_{SS} (ADREFM = 0), target ANI pin : ANI0 to ANI7, ANI16, ANI17, ANI19, internal reference voltage, and temperature sensor output voltage

(T_A = -40 to +105°C, 2.4 V ≤ V_{DD} ≤ 5.5 V, V_{SS} = 0 V, Reference voltage (+) = V_{DD}, Reference voltage (-) = V_{SS})

| Parameter | Symbol | Conditions | | MIN. | TYP. | MAX. | Unit |
|--|-------------------|---|---------------------------------|---------------------------------------|------|-----------------|------|
| Resolution | R _{ES} | | | 8 | | 10 | bit |
| Overall error ^{Notes 1, 2} | AINL | 10-bit resolution | 2.4 V ≤ V _{DD} ≤ 5.5 V | | 1.2 | ±7.0 | LSB |
| Conversion time | t _{CONV} | 10-bit resolution Target ANI pin : ANI0 to ANI7, ANI16, ANI17, ANI19 | 3.6 V ≤ V _{DD} ≤ 5.5 V | 2.125 | | 39 | μs |
| | | | 2.7 V ≤ V _{DD} ≤ 5.5 V | 3.1875 | | 39 | μs |
| | | | 2.4 V ≤ V _{DD} ≤ 5.5 V | 17 | | 39 | μs |
| | | 10-bit resolution Target ANI pin : Internal reference voltage, and temperature sensor output voltage (HS (high-speed main) mode) | 3.6 V ≤ V _{DD} ≤ 5.5 V | 2.375 | | 39 | μs |
| | | | 2.7 V ≤ V _{DD} ≤ 5.5 V | 3.5625 | | 39 | μs |
| | | | 2.4 V ≤ V _{DD} ≤ 5.5 V | 17 | | 39 | μs |
| Zero-scale error ^{Notes 1, 2} | EZS | 10-bit resolution | 2.4 V ≤ V _{DD} ≤ 5.5 V | | | ±0.60 | %FSR |
| Full-scale error ^{Notes 1, 2} | EFS | 10-bit resolution | 2.4 V ≤ V _{DD} ≤ 5.5 V | | | ±0.60 | %FSR |
| Integral linearity error ^{Note 1} | ILE | 10-bit resolution | 2.4 V ≤ V _{DD} ≤ 5.5 V | | | ±4.0 | LSB |
| Differential linearity error ^{Note 1} | DLE | 10-bit resolution | 2.4 V ≤ V _{DD} ≤ 5.5 V | | | ±2.0 | LSB |
| Analog input voltage | V _{AIN} | ANI0 to ANI7, ANI16, ANI17, ANI19 | | 0 | | V _{DD} | V |
| | | Internal reference voltage (2.4 V ≤ V _{DD} ≤ 5.5 V, HS (high-speed main) mode) | | V _{BGR} ^{Note 3} | | | V |
| | | Temperature sensor output voltage (2.4 V ≤ V _{DD} ≤ 5.5 V, HS (high-speed main) mode) | | V _{TMPS25} ^{Note 3} | | | V |

Notes 1. Excludes quantization error (±1/2 LSB).

2. This value is indicated as a ratio (%FSR) to the full-scale value.

3. Refer to **3.6.2 Temperature sensor/internal reference voltage characteristics**.

(4) When Reference voltage (+) = Internal reference voltage (ADREFP1 = 1, ADREFP0 = 0), Reference voltage (-) = $AV_{REFM}/ANI1$ (ADREFM = 1), target pin : ANI0 to ANI7, ANI16, ANI17, ANI19

($T_A = -40$ to $+105^{\circ}\text{C}$, $2.4\text{ V} \leq V_{DD} \leq 5.5\text{ V}$, $V_{SS} = 0\text{ V}$, Reference voltage (+) = V_{BGR} ^{Note 3}, Reference voltage (-) = AV_{REFM} ^{Note 4} = 0 V, HS (high-speed main) mode)

| Parameter | Symbol | Conditions | | MIN. | TYP. | MAX. | Unit |
|--|------------|------------------|--|------|------|-----------------------------|---------------|
| Resolution | R_{ES} | | | 8 | | | Bit |
| Conversion time | t_{CONV} | 8-bit resolution | $2.4\text{ V} \leq V_{DD} \leq 5.5\text{ V}$ | 17 | | 39 | μs |
| Zero-scale error ^{Notes 1, 2} | E_{ZS} | 8-bit resolution | $2.4\text{ V} \leq V_{DD} \leq 5.5\text{ V}$ | | | ± 0.60 | %FSR |
| Integral linearity error ^{Note 1} | I_{LE} | 8-bit resolution | $2.4\text{ V} \leq V_{DD} \leq 5.5\text{ V}$ | | | ± 2.0 | LSB |
| Differential linearity error ^{Note 1} | D_{LE} | 8-bit resolution | $2.4\text{ V} \leq V_{DD} \leq 5.5\text{ V}$ | | | ± 1.0 | LSB |
| Analog input voltage | V_{AIN} | | | 0 | | V_{BGR} ^{Note 3} | V |

Notes 1. Excludes quantization error ($\pm 1/2$ LSB).

2. This value is indicated as a ratio (%FSR) to the full-scale value.

3. Refer to **3.6.2 Temperature sensor/internal reference voltage characteristics**.

4. When reference voltage (-) = V_{SS} , the MAX. values are as follows.

Zero-scale error: Add $\pm 0.35\%$ FSR to the MAX. value when reference voltage (-) = AV_{REFM} .

Integral linearity error: Add ± 0.5 LSB to the MAX. value when reference voltage (-) = AV_{REFM} .

Differential linearity error: Add ± 0.2 LSB to the MAX. value when reference voltage (-) = AV_{REFM} .

3.6.2 Temperature sensor/internal reference voltage characteristics

(TA = -40 to $+105^\circ\text{C}$, $2.4\text{ V} \leq V_{DD} \leq 5.5\text{ V}$, $V_{SS} = 0\text{ V}$, HS (high-speed main) mode)

| Parameter | Symbol | Conditions | MIN. | TYP. | MAX. | Unit |
|-----------------------------------|-------------|---|------|------|------|----------------------------|
| Temperature sensor output voltage | V_{TMS25} | Setting ADS register = 80H, $T_A = +25^\circ\text{C}$ | | 1.05 | | V |
| Internal reference voltage | V_{BGR} | Setting ADS register = 81H | 1.38 | 1.45 | 1.5 | V |
| Temperature coefficient | F_{VTMS} | Temperature sensor that depends on the temperature | | -3.6 | | $\text{mV}/^\circ\text{C}$ |
| Operation stabilization wait time | t_{AMP} | | 5 | | | μs |

3.6.3 POR circuit characteristics

(TA = -40 to $+105^\circ\text{C}$, $V_{SS} = 0\text{ V}$)

| Parameter | Symbol | Conditions | MIN. | TYP. | MAX. | Unit |
|-------------------------------------|-----------|------------------------|------|------|------|---------------|
| Detection voltage | V_{POR} | Power supply rise time | 1.45 | 1.51 | 1.57 | V |
| | V_{PDR} | Power supply fall time | 1.44 | 1.50 | 1.56 | V |
| Minimum pulse width ^{Note} | T_{PW} | | 300 | | | μs |

Note Minimum time required for a POR reset when V_{DD} exceeds below V_{PDR} . This is also the minimum time required for a POR reset from when V_{DD} exceeds below 0.7 V to when V_{DD} exceeds V_{POR} while STOP mode is entered or the main system clock (f_{MAIN}) is stopped through setting bit 0 (HIOSTOP) and bit 7 (MSTOP) in the clock operation status control register (CSC).

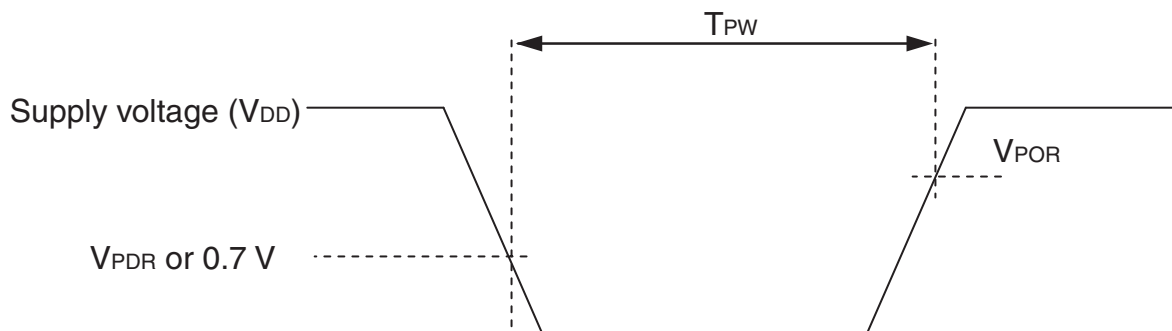

3.6.4 LVD circuit characteristics

LVD Detection Voltage of Reset Mode and Interrupt Mode**($T_A = -40$ to $+105^\circ\text{C}$, $V_{PDR} \leq V_{DD} \leq 5.5$ V, $V_{SS} = 0$ V)**

| Parameter | | Symbol | Conditions | MIN. | TYP. | MAX. | Unit |
|----------------------|----------------------|-------------------|------------------------|------|------|------|------|
| Detection voltage | Supply voltage level | V _{LVD0} | Power supply rise time | 3.90 | 4.06 | 4.22 | V |
| | | | Power supply fall time | 3.83 | 3.98 | 4.13 | V |
| | | V _{LVD1} | Power supply rise time | 3.60 | 3.75 | 3.90 | V |
| | | | Power supply fall time | 3.53 | 3.67 | 3.81 | V |
| | | V _{LVD2} | Power supply rise time | 3.01 | 3.13 | 3.25 | V |
| | | | Power supply fall time | 2.94 | 3.06 | 3.18 | V |
| | | V _{LVD3} | Power supply rise time | 2.90 | 3.02 | 3.14 | V |
| | | | Power supply fall time | 2.85 | 2.96 | 3.07 | V |
| | | V _{LVD4} | Power supply rise time | 2.81 | 2.92 | 3.03 | V |
| | | | Power supply fall time | 2.75 | 2.86 | 2.97 | V |
| | | V _{LVD5} | Power supply rise time | 2.70 | 2.81 | 2.92 | V |
| | | | Power supply fall time | 2.64 | 2.75 | 2.86 | V |
| | | V _{LVD6} | Power supply rise time | 2.61 | 2.71 | 2.81 | V |
| | | | Power supply fall time | 2.55 | 2.65 | 2.75 | V |
| | | V _{LVD7} | Power supply rise time | 2.51 | 2.61 | 2.71 | V |
| | | | Power supply fall time | 2.45 | 2.55 | 2.65 | V |
| Minimum pulse width | | t _{LW} | | 300 | | | μs |
| Detection delay time | | t _{LD} | | | | 300 | μs |

LVD Detection Voltage of Interrupt & Reset Mode**($T_A = -40$ to $+105^\circ\text{C}$, $V_{PDR} \leq V_{DD} \leq 5.5$ V, $V_{SS} = 0$ V)**

| Parameter | Symbol | Conditions | MIN. | TYP. | MAX. | Unit | |
|---------------------------|-------------|--|------------------------------|------|------|------|---|
| Interrupt and reset mode | V_{LVDD0} | VPOC2, VPOC1, VPOC0 = 0, 1, 1, falling reset voltage | 2.64 | 2.75 | 2.86 | V | |
| | V_{LVDD1} | LVIS1, LVIS0 = 1, 0 | Rising release reset voltage | 2.81 | 2.92 | 3.03 | V |
| | | | Falling interrupt voltage | 2.75 | 2.86 | 2.97 | V |
| | V_{LVDD2} | LVIS1, LVIS0 = 0, 1 | Rising release reset voltage | 2.90 | 3.02 | 3.14 | V |
| | | | Falling interrupt voltage | 2.85 | 2.96 | 3.07 | V |
| | V_{LVDD3} | LVIS1, LVIS0 = 0, 0 | Rising release reset voltage | 3.90 | 4.06 | 4.22 | V |
| Falling interrupt voltage | | | 3.83 | 3.98 | 4.13 | V | |

3.6.5 Power supply voltage rising slope characteristics

($T_A = -40$ to $+105^\circ\text{C}$, $V_{SS} = 0$ V)

| Parameter | Symbol | Conditions | MIN. | TYP. | MAX. | Unit |
|-----------------------------------|-----------|------------|------|------|------|------|
| Power supply voltage rising slope | S_{VDD} | | | | 54 | V/ms |

Caution Make sure to keep the internal reset state by the LVD circuit or an external reset until V_{DD} reaches the operating voltage range shown in 3.4 AC Characteristics.

3.7 RAM Data Retention Characteristics

(T_A = -40 to +105°C, V_{SS} = 0 V)

| Parameter | Symbol | Conditions | MIN. | TYP. | MAX. | Unit |
|-------------------------------|-------------------|------------|----------------------|------|------|------|
| Data retention supply voltage | V _{DDDR} | | 1.44 ^{Note} | | 5.5 | V |

Note The value depends on the POR detection voltage. When the voltage drops, the data is retained before a POR reset is effected, but data is not retained when a POR reset is effected.

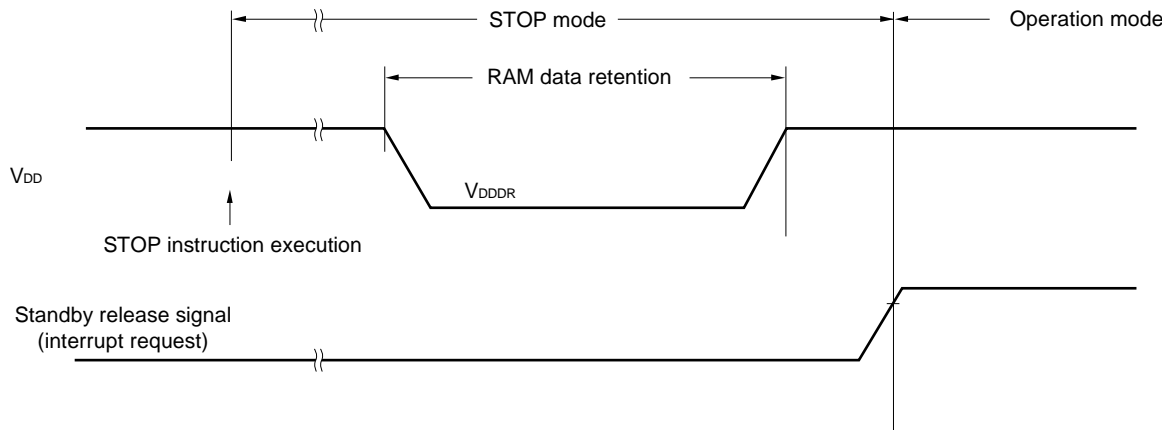

3.8 Flash Memory Programming Characteristics

(T_A = -40 to +105°C, 2.4 V ≤ V_{DD} ≤ 5.5 V, V_{SS} = 0 V)

| Parameter | Symbol | Conditions | MIN. | TYP. | MAX. | Unit |
|--|-------------------|---|---------|-----------|------|-------|
| CPU/peripheral hardware clock frequency | f _{CLK} | 2.4 V ≤ V _{DD} ≤ 5.5 V | 1 | | 24 | MHz |
| Number of code flash rewrites | C _{erwr} | Retaining years: 20 years T _A = +85°C ^{Note 4} | 1,000 | | | Times |
| Number of data flash rewrites Notes 1, 2, 3 | | Retaining years: 1 year T _A = +25°C ^{Note 4} | | 1,000,000 | | |
| | | Retaining years: 5 years T _A = +85°C ^{Note 4} | 100,000 | | | |
| | | Retaining years: 20 years T _A = +85°C ^{Note 4} | 10,000 | | | |

- Notes**
- 1 erase + 1 write after the erase is regarded as 1 rewrite. The retaining years are until next rewrite after the rewrite.
 2. When using flash memory programmer and Renesas Electronics self programming library.
 3. These specifications show the characteristics of the flash memory and the results obtained from Renesas Electronics reliability testing.
 4. This temperature is the average value at which data are retained.

3.9 Dedicated Flash Memory Programmer Communication (UART)

(T_A = -40 to +105°C, 2.4 V ≤ V_{DD} ≤ 5.5 V, V_{SS} = 0 V)

| Parameter | Symbol | Conditions | MIN. | TYP. | MAX. | Unit |
|---------------|--------|---------------------------|---------|------|-----------|------|
| Transfer rate | | During serial programming | 115,200 | | 1,000,000 | bps |

3.10 Timing Specs for Switching Flash Memory Programming Modes

(T_A = -40 to +105°C, 2.4 V ≤ V_{DD} ≤ 5.5 V, V_{SS} = 0 V)

| Parameter | Symbol | Conditions | MIN. | TYP. | MAX. | Unit |
|---|---------------------|--|------|------|------|------|
| How long from when an external reset ends until the initial communication settings are specified | t _{SUINIT} | POR and LVD reset must end before the external reset ends. | | | 100 | ms |
| How long from when the TOOL0 pin is placed at the low level until an external reset ends | t _{SU} | POR and LVD reset must end before the external reset ends. | 10 | | | μs |
| How long the TOOL0 pin must be kept at the low level after an external reset ends (excluding the processing time of the firmware to control the flash memory) | t _{HD} | POR and LVD reset must end before the external reset ends. | 1 | | | ms |

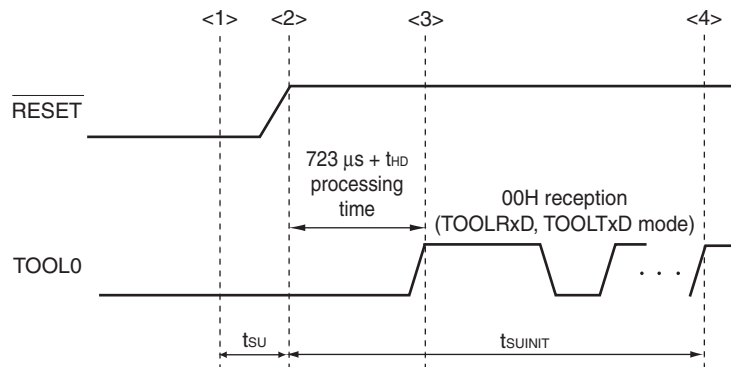

- <1> The low level is input to the TOOL0 pin.
- <2> The external reset ends (POR and LVD reset must end before the external reset ends.).
- <3> The TOOL0 pin is set to the high level.
- <4> Setting of the flash memory programming mode by UART reception and complete the baud rate setting.

Remark t_{SUINIT}: The segment shows that it is necessary to finish specifying the initial communication settings within 100 ms from when the resets end.

t_{SU}: How long from when the TOOL0 pin is placed at the low level until an external reset ends

t_{HD}: How long to keep the TOOL0 pin at the low level from when the external and internal resets end (excluding the processing time of the firmware to control the flash memory)

4. PACKAGE DRAWINGS

4.1 32-pin Products

<R>

| | | | |
|--------------------|--------------|----------------|-----------------|
| JEITA Package Code | RENESAS Code | Previous Code | MASS (TYP.) [g] |
| P-LQFP32-7x7-0.80 | PLQP0032GB-A | P32GA-80-GBT-1 | 0.2 |

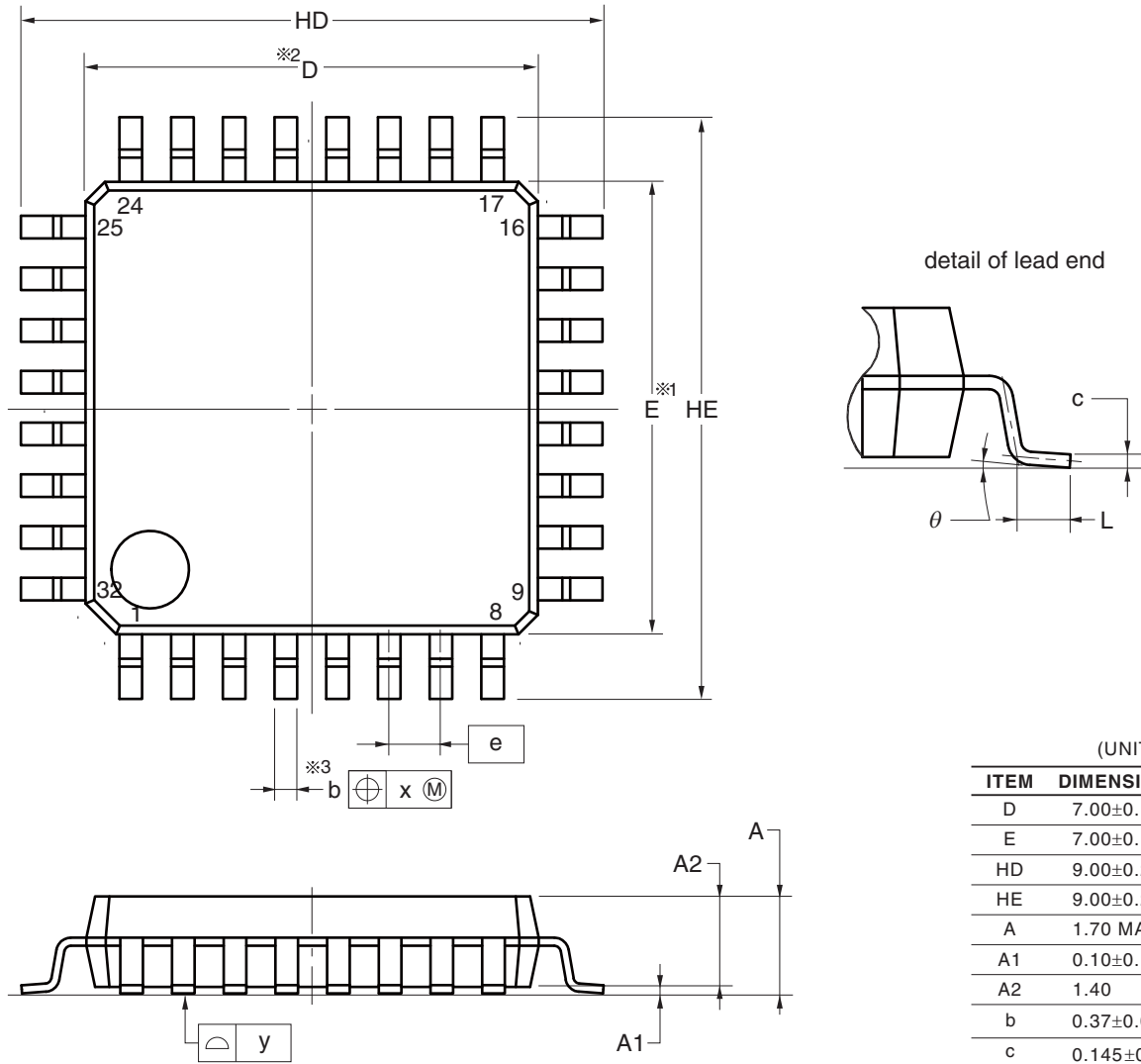

(UNIT:mm)

| ITEM | DIMENSIONS |
|------|-------------|
| D | 7.00±0.10 |
| E | 7.00±0.10 |
| HD | 9.00±0.20 |
| HE | 9.00±0.20 |
| A | 1.70 MAX. |
| A1 | 0.10±0.10 |
| A2 | 1.40 |
| b | 0.37±0.05 |
| c | 0.145±0.055 |
| L | 0.50±0.20 |
| θ | 0° to 8° |
| e | 0.80 |
| x | 0.20 |
| y | 0.10 |

NOTE

- 1. Dimensions “※1” and “※2” do not include mold flash.
- 2. Dimension “※3” does not include trim offset.

<R>

| | | | |
|--------------------|--------------|----------------|----------------|
| JEITA Package code | RENESAS code | Previous code | MASS (TYP.)[g] |
| P-HWQFN32-5x5-0.50 | PWQN0032KB-A | P32K8-50-3B4-5 | 0.06 |

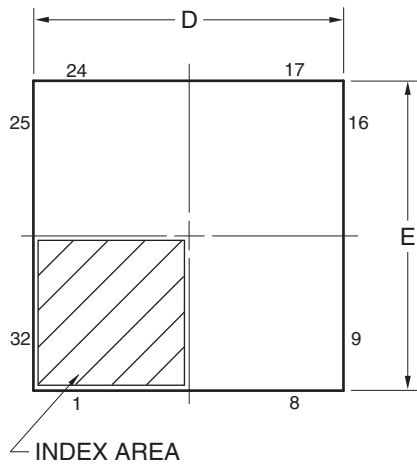

DETAIL OF (A) PART

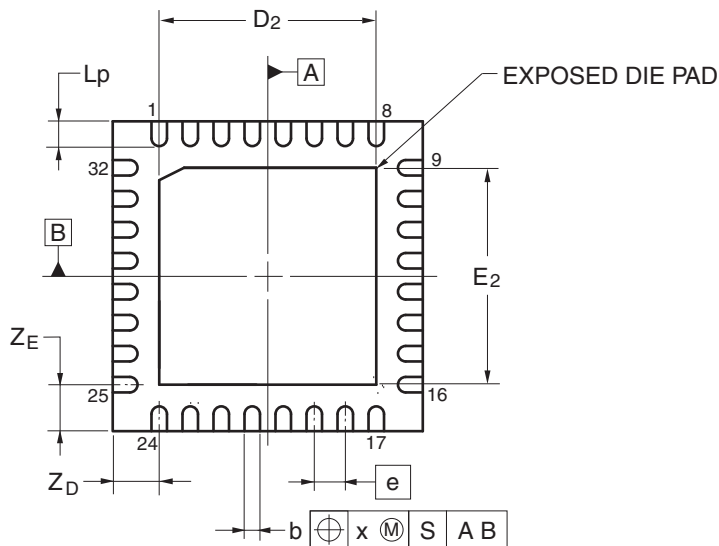
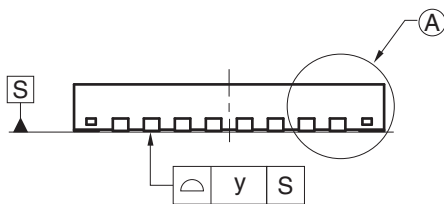
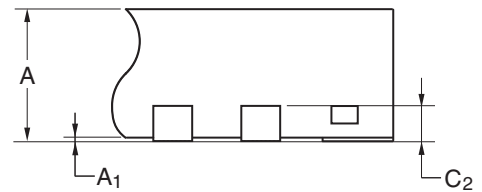

| Reference Symbol | Dimension in Millimeters | | |
|------------------|--------------------------|------|------|
| | Min | Nom | Max |
| D | 4.95 | 5.00 | 5.05 |
| E | 4.95 | 5.00 | 5.05 |
| A | — | — | 0.80 |
| A ₁ | 0.00 | — | — |
| b | 0.18 | 0.25 | 0.30 |
| e | — | 0.50 | — |
| L _p | 0.30 | 0.40 | 0.50 |
| x | — | — | 0.05 |
| y | — | — | 0.05 |
| Z _D | — | 0.75 | — |
| Z _E | — | 0.75 | — |
| c ₂ | 0.15 | 0.20 | 0.25 |
| D ₂ | — | 3.50 | — |
| E ₂ | — | 3.50 | — |

©2013 Renesas Electronics Corporation. All rights reserved.

<R>

| | | |
|---------------------|--------------|---------------|
| JEITA Package code | RENESAS code | MASS(TYP.)[g] |
| P-HWQFN032-5x5-0.50 | PWQN0032KE-A | 0.06 |

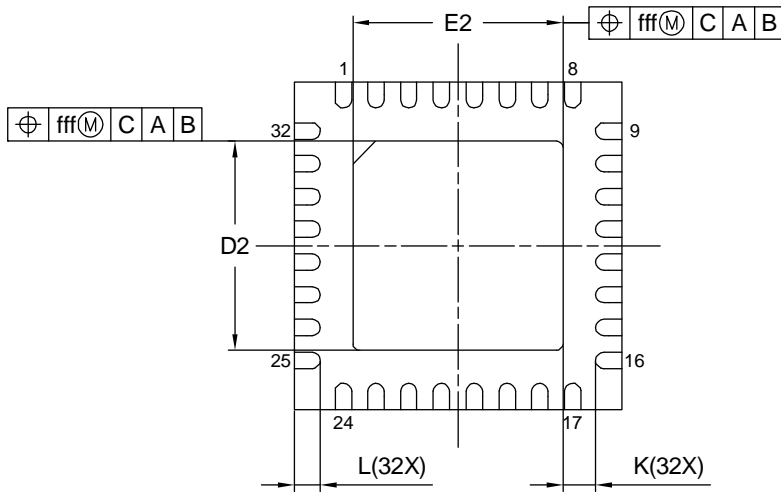
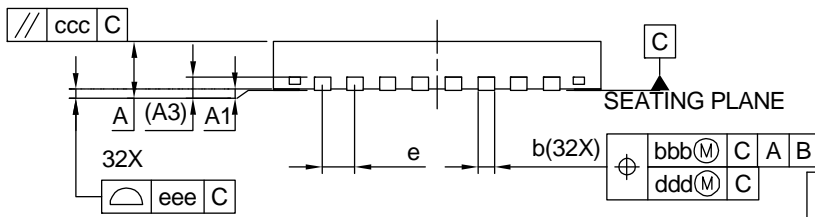
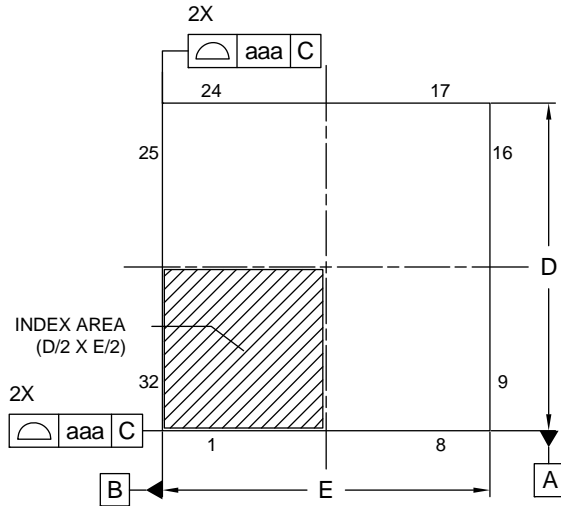

| Reference Symbol | Dimension in Millimeters | | |
|------------------|--------------------------|------|------|
| | Min. | Nom. | Max. |
| A | - | - | 0.80 |
| A ₁ | 0.00 | 0.02 | 0.05 |
| A ₃ | 0.203 REF. | | |
| b | 0.18 | 0.25 | 0.30 |
| D | 5.00 BSC | | |
| E | 5.00 BSC | | |
| e | 0.50 BSC | | |
| L | 0.35 | 0.40 | 0.45 |
| K | 0.20 | - | - |
| D ₂ | 3.15 | 3.20 | 3.25 |
| E ₂ | 3.15 | 3.20 | 3.25 |
| aaa | 0.15 | | |
| bbb | 0.10 | | |
| ccc | 0.10 | | |
| ddd | 0.05 | | |
| eee | 0.08 | | |
| fff | 0.10 | | |

4.2 48-pin Products

<R>

| | | | |
|--------------------|--------------|----------------|-----------------|
| JEITA Package Code | RENESAS Code | Previous Code | MASS (TYP.) [g] |
| P-LFQFP48-7x7-0.50 | PLQP0048KF-A | P48GA-50-8EU-1 | 0.16 |

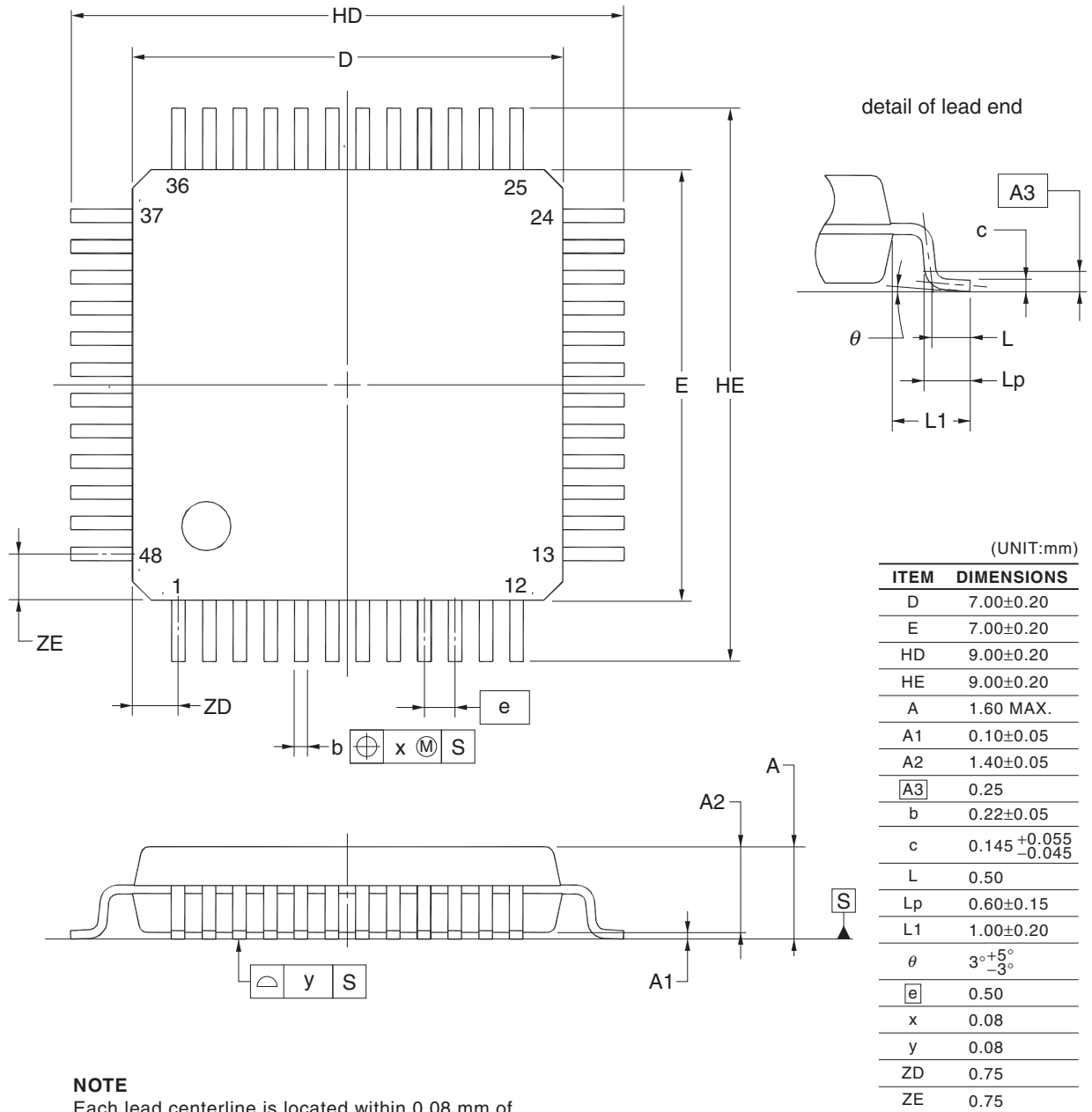

NOTE
Each lead centerline is located within 0.08 mm of its true position at maximum material condition.

©2012 Renesas Electronics Corporation. All rights reserved.

<R>

| JEITA Package Code | RENESAS Code | Previous Code | MASS (Typ) [g] |
|--------------------|--------------|---------------------------|----------------|
| P-HWQFN48-7x7-0.50 | PWQN0048KB-A | 48PJN-A P48K8-50-5B4-7 | 0.13 |

Unit: mm

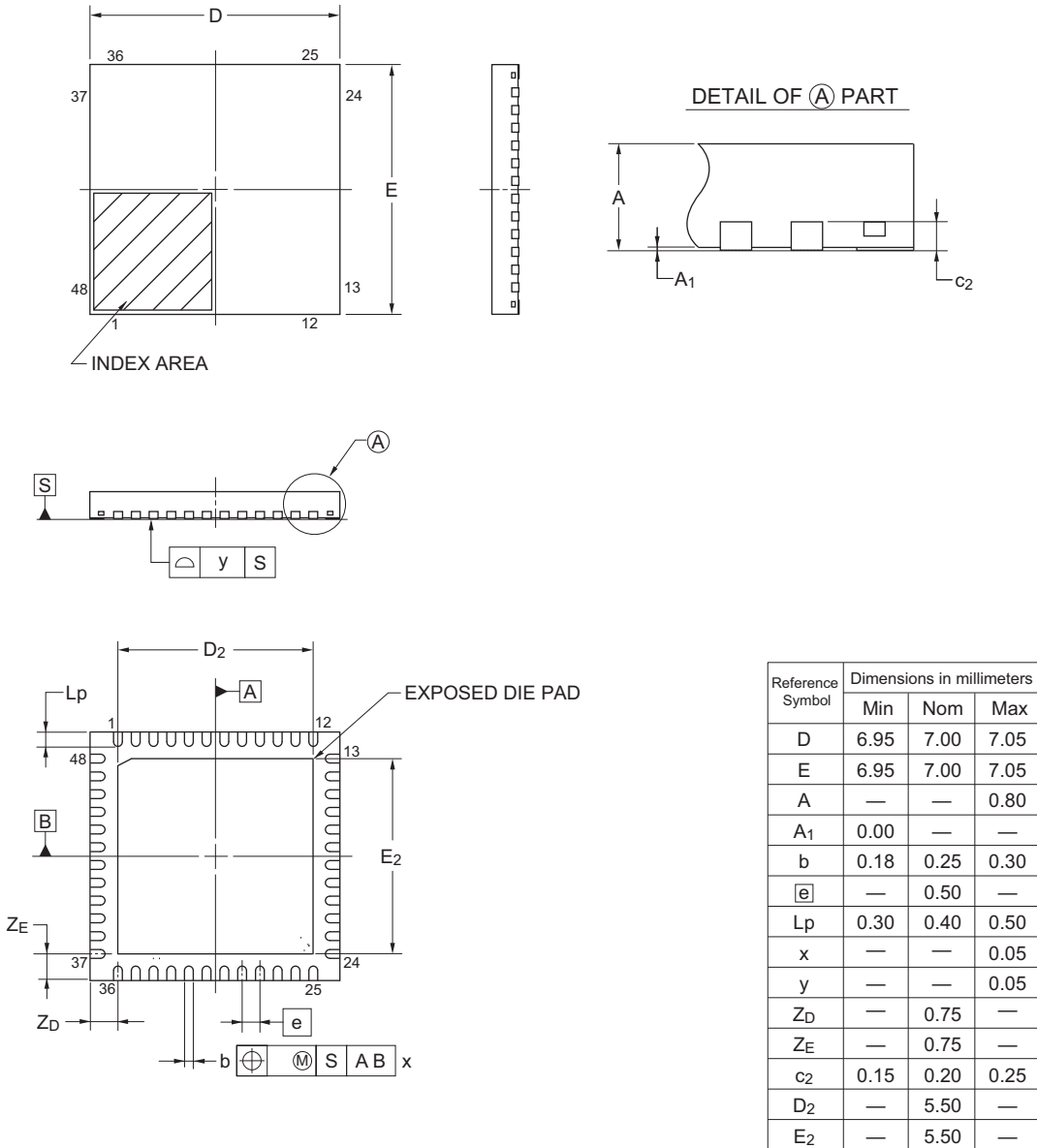

© 2015 Renesas Electronics Corporation. All rights reserved.

<R>

| | | |
|---------------------|--------------|---------------|
| JEITA Package code | RENESAS code | MASS(TYP.)[g] |
| P-HWQFN048-7x7-0.50 | PWQN0048KE-A | 0.13 |

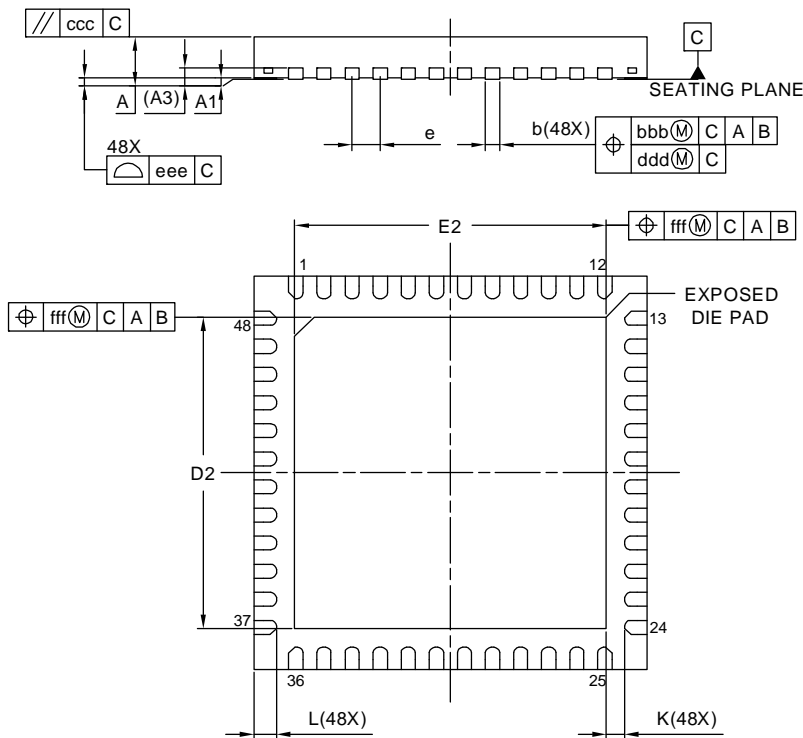
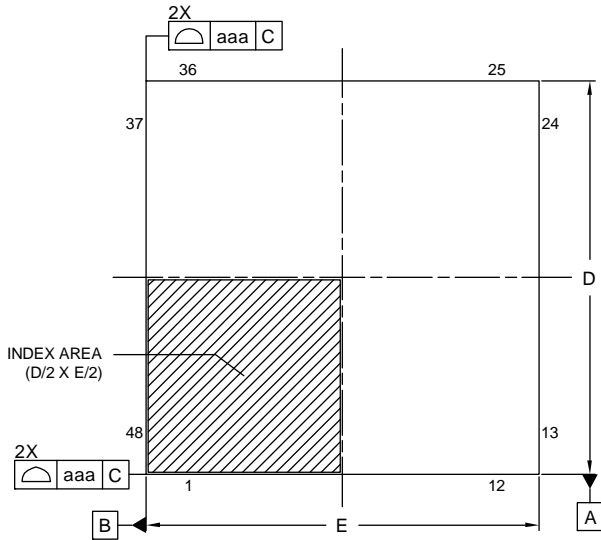

| Reference Symbol | Dimension in Millimeters | | |
|------------------|--------------------------|------|------|
| | Min. | Nom. | Max. |
| A | - | - | 0.80 |
| A ₁ | 0.00 | 0.02 | 0.05 |
| A ₃ | 0.203 REF. | | |
| b | 0.20 | 0.25 | 0.30 |
| D | 7.00 BSC | | |
| E | 7.00 BSC | | |
| e | 0.50 BSC | | |
| L | 0.30 | 0.40 | 0.50 |
| K | 0.20 | - | - |
| D ₂ | 5.50 | 5.55 | 5.60 |
| E ₂ | 5.50 | 5.55 | 5.60 |
| aaa | 0.15 | | |
| bbb | 0.10 | | |
| ccc | 0.10 | | |
| ddd | 0.05 | | |
| eee | 0.08 | | |
| fff | 0.10 | | |

Revision History

RL78/G1A Data Sheet

| Rev. | Date | Description | |
|-----------|--|-------------|--|
| | | Page | Summary |
| 0.01 | Sep 20, 2012 | - | First Edition issued |
| 1.00 | Aug 08, 2013 | Throughout | Deletion of the bar over SCK and SCKxx |
| | | | Renaming of f _{EXT} to f _{EXS} |
| | | | Renaming of interval timer (unit) to 12-bit interval timer |
| | | | Addition of products for G: Industrial applications (T _A = -40 to +105 °C) |
| | | 1 | Change of 1.1 Features |
| | | 2 | Change of 1.2 List of Part Numbers |
| | | 3 | Modification of Figure 1-1. Part Number, Memory Size, and Package of RL78/G1C |
| | | 4, 5 | Addition of remark to 1.3 Pin Configuration (Top View) |
| | | 15, 16 | Change of 1.6 Outline of Functions |
| | | 17 to 76 | Addition of a whole chapter |
| 77 to 131 | Addition of a whole chapter | | |
| 132 | Addition of products for G: Industrial applications (T _A = -40 to +105 °C) | | |
| 1.10 | Nov 15, 2013 | 77 | Caution 3 added. |
| | | 79 | Note for operating ambient temperature in 3.1 Absolute Maximum Ratings deleted. |
| 1.20 | Sep 30, 2016 | 4 to 7 | Modification of pin configuration in 1.3.1 32-pin products |
| | | 8 to 11 | Modification of pin configuration in 1.3.2 48-pin products |
| | | 15 | Modification of description of main system clock in 1.6 Outline of Functions |
| | | 74 | Modification of title of 2.7 RAM Data Retention Characteristics and figure |
| | | 74 | Modification of table of 2.8 Flash Memory Programming Characteristics |
| | | 129 | Modification of title of 3.7 RAM Data Retention Characteristics and figure |
| | | 129 | Modification of table of 3.8 Flash Memory Programming Characteristics and addition of Note 4 |
| | | 132 | Change of figure in 4.1 32-pin Products |
| 134 | Change of figure in 4.2 48-pin Products | | |
| 1.21 | Dec 22, 2020 | 2 | Addition of title and modification of description in Table 1-1 List of Ordering Part Numbers |
| | | 3 | Modification of Figure 1-1 Part Number, Memory Size, and Package of RL78/G1C |
| | | 131 to 136 | Addition and modification of all in 4 PACKAGE DRAWINGS |

SuperFlash is a registered trademark of Silicon Storage Technology, Inc. in several countries including the United States and Japan.

Caution: This product uses SuperFlash® technology licensed from Silicon Storage Technology, Inc.

All trademarks and registered trademarks are the property of their respective owners.

General Precautions in the Handling of Microprocessing Unit and Microcontroller Unit Products

The following usage notes are applicable to all Microprocessing unit and Microcontroller unit products from Renesas. For detailed usage notes on the products covered by this document, refer to the relevant sections of the document as well as any technical updates that have been issued for the products.

1. Precaution against Electrostatic Discharge (ESD)

A strong electrical field, when exposed to a CMOS device, can cause destruction of the gate oxide and ultimately degrade the device operation. Steps must be taken to stop the generation of static electricity as much as possible, and quickly dissipate it when it occurs. Environmental control must be adequate. When it is dry, a humidifier should be used. This is recommended to avoid using insulators that can easily build up static electricity.

Semiconductor devices must be stored and transported in an anti-static container, static shielding bag or conductive material. All test and measurement tools including work benches and floors must be grounded. The operator must also be grounded using a wrist strap. Semiconductor devices must not be touched with bare hands. Similar precautions must be taken for printed circuit boards with mounted semiconductor devices.

2. Processing at power-on

The state of the product is undefined at the time when power is supplied. The states of internal circuits in the LSI are indeterminate and the states of register settings and pins are undefined at the time when power is supplied. In a finished product where the reset signal is applied to the external reset pin, the states of pins are not guaranteed from the time when power is supplied until the reset process is completed. In a similar way, the states of pins in a product that is reset by an on-chip power-on reset function are not guaranteed from the time when power is supplied until the power reaches the level at which resetting is specified.

3. Input of signal during power-off state

Do not input signals or an I/O pull-up power supply while the device is powered off. The current injection that results from input of such a signal or I/O pull-up power supply may cause malfunction and the abnormal current that passes in the device at this time may cause degradation of internal elements. Follow the guideline for input signal during power-off state as described in your product documentation.

4. Handling of unused pins

Handle unused pins in accordance with the directions given under handling of unused pins in the manual. The input pins of CMOS products are generally in the high-impedance state. In operation with an unused pin in the open-circuit state, extra electromagnetic noise is induced in the vicinity of the LSI, an associated shoot-through current flows internally, and malfunctions occur due to the false recognition of the pin state as an input signal become possible.

5. Clock signals

After applying a reset, only release the reset line after the operating clock signal becomes stable. When switching the clock signal during program execution, wait until the target clock signal is stabilized. When the clock signal is generated with an external resonator or from an external oscillator during a reset, ensure that the reset line is only released after full stabilization of the clock signal. Additionally, when switching to a clock signal produced with an external resonator or by an external oscillator while program execution is in progress, wait until the target clock signal is stable.

6. Voltage application waveform at input pin

Waveform distortion due to input noise or a reflected wave may cause malfunction. If the input of the CMOS device stays in the area between V_{IL} (Max.) and V_{IH} (Min.) due to noise, for example, the device may malfunction. Take care to prevent chattering noise from entering the device when the input level is fixed, and also in the transition period when the input level passes through the area between V_{IL} (Max.) and V_{IH} (Min.).

7. Prohibition of access to reserved addresses

Access to reserved addresses is prohibited. The reserved addresses are provided for possible future expansion of functions. Do not access these addresses as the correct operation of the LSI is not guaranteed.

8. Differences between products

Before changing from one product to another, for example to a product with a different part number, confirm that the change will not lead to problems. The characteristics of a microprocessing unit or microcontroller unit products in the same group but having a different part number might differ in terms of internal memory capacity, layout pattern, and other factors, which can affect the ranges of electrical characteristics, such as characteristic values, operating margins, immunity to noise, and amount of radiated noise. When changing to a product with a different part number, implement a system-evaluation test for the given product.

Notice

1. Descriptions of circuits, software and other related information in this document are provided only to illustrate the operation of semiconductor products and application examples. You are fully responsible for the incorporation or any other use of the circuits, software, and information in the design of your product or system. Renesas Electronics disclaims any and all liability for any losses and damages incurred by you or third parties arising from the use of these circuits, software, or information.
2. Renesas Electronics hereby expressly disclaims any warranties against and liability for infringement or any other claims involving patents, copyrights, or other intellectual property rights of third parties, by or arising from the use of Renesas Electronics products or technical information described in this document, including but not limited to, the product data, drawings, charts, programs, algorithms, and application examples.
3. No license, express, implied or otherwise, is granted hereby under any patents, copyrights or other intellectual property rights of Renesas Electronics or others.
4. You shall not alter, modify, copy, or reverse engineer any Renesas Electronics product, whether in whole or in part. Renesas Electronics disclaims any and all liability for any losses or damages incurred by you or third parties arising from such alteration, modification, copying or reverse engineering.
5. Renesas Electronics products are classified according to the following two quality grades: "Standard" and "High Quality". The intended applications for each Renesas Electronics product depends on the product's quality grade, as indicated below.
"Standard": Computers; office equipment; communications equipment; test and measurement equipment; audio and visual equipment; home electronic appliances; machine tools; personal electronic equipment; industrial robots; etc.
"High Quality": Transportation equipment (automobiles, trains, ships, etc.); traffic control (traffic lights); large-scale communication equipment; key financial terminal systems; safety control equipment; etc.
Unless expressly designated as a high reliability product or a product for harsh environments in a Renesas Electronics data sheet or other Renesas Electronics document, Renesas Electronics products are not intended or authorized for use in products or systems that may pose a direct threat to human life or bodily injury (artificial life support devices or systems; surgical implantations; etc.), or may cause serious property damage (space system; undersea repeaters; nuclear power control systems; aircraft control systems; key plant systems; military equipment; etc.). Renesas Electronics disclaims any and all liability for any damages or losses incurred by you or any third parties arising from the use of any Renesas Electronics product that is inconsistent with any Renesas Electronics data sheet, user's manual or other Renesas Electronics document.
6. When using Renesas Electronics products, refer to the latest product information (data sheets, user's manuals, application notes, "General Notes for Handling and Using Semiconductor Devices" in the reliability handbook, etc.), and ensure that usage conditions are within the ranges specified by Renesas Electronics with respect to maximum ratings, operating power supply voltage range, heat dissipation characteristics, installation, etc. Renesas Electronics disclaims any and all liability for any malfunctions, failure or accident arising out of the use of Renesas Electronics products outside of such specified ranges.
7. Although Renesas Electronics endeavors to improve the quality and reliability of Renesas Electronics products, semiconductor products have specific characteristics, such as the occurrence of failure at a certain rate and malfunctions under certain use conditions. Unless designated as a high reliability product or a product for harsh environments in a Renesas Electronics data sheet or other Renesas Electronics document, Renesas Electronics products are not subject to radiation resistance design. You are responsible for implementing safety measures to guard against the possibility of bodily injury, injury or damage caused by fire, and/or danger to the public in the event of a failure or malfunction of Renesas Electronics products, such as safety design for hardware and software, including but not limited to redundancy, fire control and malfunction prevention, appropriate treatment for aging degradation or any other appropriate measures. Because the evaluation of microcomputer software alone is very difficult and impractical, you are responsible for evaluating the safety of the final products or systems manufactured by you.
8. Please contact a Renesas Electronics sales office for details as to environmental matters such as the environmental compatibility of each Renesas Electronics product. You are responsible for carefully and sufficiently investigating applicable laws and regulations that regulate the inclusion or use of controlled substances, including without limitation, the EU RoHS Directive, and using Renesas Electronics products in compliance with all these applicable laws and regulations. Renesas Electronics disclaims any and all liability for damages or losses occurring as a result of your noncompliance with applicable laws and regulations.
9. Renesas Electronics products and technologies shall not be used for or incorporated into any products or systems whose manufacture, use, or sale is prohibited under any applicable domestic or foreign laws or regulations. You shall comply with any applicable export control laws and regulations promulgated and administered by the governments of any countries asserting jurisdiction over the parties or transactions.
10. It is the responsibility of the buyer or distributor of Renesas Electronics products, or any other party who distributes, disposes of, or otherwise sells or transfers the product to a third party, to notify such third party in advance of the contents and conditions set forth in this document.
11. This document shall not be reprinted, reproduced or duplicated in any form, in whole or in part, without prior written consent of Renesas Electronics.
12. Please contact a Renesas Electronics sales office if you have any questions regarding the information contained in this document or Renesas Electronics products.

(Note 1) "Renesas Electronics" as used in this document means Renesas Electronics Corporation and also includes its directly or indirectly controlled subsidiaries.

(Note 2) "Renesas Electronics product(s)" means any product developed or manufactured by or for Renesas Electronics.

(Rev.4.0-1 November 2017)



SALES OFFICES

Renesas Electronics Corporation

<http://www.renesas.com>

Refer to "<http://www.renesas.com/>" for the latest and detailed information.

Renesas Electronics Corporation

TOYOSU FORESIA, 3-2-24 Toyosu, Koto-ku, Tokyo 135-0061, Japan

Renesas Electronics America Inc. Milpitas Campus

1001 Murphy Ranch Road, Milpitas, CA 95035, U.S.A.

Tel: +1-408-432-8888, Fax: +1-408-434-5351

Renesas Electronics America Inc. San Jose Campus

6024 Silver Creek Valley Road, San Jose, CA 95138, USA

Tel: +1-408-284-8200, Fax: +1-408-284-2775

Renesas Electronics Canada Limited

9251 Yonge Street, Suite 8309 Richmond Hill, Ontario Canada L4C 9T3

Tel: +1-905-237-2004

Renesas Electronics Europe GmbH

Arcadiastrasse 10, 40472 Düsseldorf, Germany

Tel: +49-211-6503-0, Fax: +49-211-6503-1327

Renesas Electronics (China) Co., Ltd.

Room 101-T01, Floor 1, Building 7, Yard No. 7, 8th Street, Shangdi, Haidian District, Beijing 100085, China

Tel: +86-10-8235-1155, Fax: +86-10-8235-7679

Renesas Electronics (Shanghai) Co., Ltd.

Unit 301, Tower A, Central Towers, 555 Langao Road, Putuo District, Shanghai 200333, China

Tel: +86-21-2226-0888, Fax: +86-21-2226-0999

Renesas Electronics Hong Kong Limited

Unit 1601-1611, 16/F., Tower 2, Grand Century Place, 193 Prince Edward Road West, Mongkok, Kowloon, Hong Kong

Tel: +852-2265-6688, Fax: +852 2886-9022

Renesas Electronics Taiwan Co., Ltd.

13F, No. 363, Fu Shing North Road, Taipei 10543, Taiwan

Tel: +886-2-8175-9600, Fax: +886 2-8175-9670

Renesas Electronics Singapore Pte. Ltd.

80 Bendemeer Road, #06-02 Singapore 339949

Tel: +65-6213-0200, Fax: +65-6213-0300

Renesas Electronics Malaysia Sdn.Bhd.

Unit No 3A-1 Level 3A Tower 8 UOA Business Park, No 1 Jalan Pengerutcara U1/51A, Seksyen U1, 40150 Shah Alam, Selangor, Malaysia

Tel: +60-3-5022-1288, Fax: +60-3-5022-1290

Renesas Electronics India Pvt. Ltd.

No.77C, 100 Feet Road, HAL 2nd Stage, Indiranagar, Bangalore 560 038, India

Tel: +91-80-67208700

Renesas Electronics Korea Co., Ltd.

17F, KAMCO Yangjae Tower, 262, Gangnam-daero, Gangnam-gu, Seoul, 06265 Korea

Tel: +82-2-558-3737, Fax: +82-2-558-5338