



Introduction

The EK3LV02DL is an Evaluation Kit designed to provide to the user a complete, ready-to-use platform for the evaluation of the LIS3LV02DL, a low-power 3-Axis linear accelerometer with digital output that includes a sensing element and an IC interface able to take information from the sensing element and to provide the measured signal to the external world.

Besides the MEMS sensor, the evaluation board mounts an ST7-USB microcontroller which acts like a bridge between the sensor and the personal computer on which it is possible to run either a Graphical User Interface delivered with the kit itself or dedicated SW routines that implements customized applications.

This user manual describes the HW composing the evaluation kit and gives the informations required to install and to run the evaluation kit user interface.

For any detail about the features implemented by the LIS3LV02DL sensor refer to LIS3LV02DL datasheet and to the Application Note AN2381

Contents

- 1 Evaluation kit description 6**
- 2 EK3LV02DL GUI installation 8**
 - 2.1 PC system requirements 8
 - 2.2 Software installation 8
 - 2.3 Hardware installation 9
- 3 Graphical User Interface 12**
 - 3.1 Connecting to Virtual the COM port 13
 - 3.2 Registers Read/Write 13
 - 3.3 Direction detection demo 13
 - 3.4 Data Acquisition 15
 - 3.4.1 Single Acquisition mode 15
 - 3.4.2 Continuous Acquisition mode 15
 - 3.5 About_EK 19
- 4 Data acquisition quick start 21**
- 5 EK lite 22**
- 6 MEMS pointer 23**
 - 6.1 GUI description 23
 - 6.1.1 Right Side: Main Controls 24
 - 6.1.2 Left Side: Pointer Application Controls 24
- 7 Supported commands 25**
 - 7.1 Getting Started 25
 - 7.2 Supported Commands 26
 - 7.2.1 Start command 26
 - 7.2.2 Debug command 26
 - 7.2.3 Stop command 27
 - 7.2.4 Registers read 27
 - 7.2.5 Registers write 27
 - 7.2.6 Single bit write 27

7.2.7	Zon and Zoff	27
7.2.8	Device name	27
7.2.9	Firmware version	28
7.3	Quick Start	28
8	Schematic diagram	29
9	Bill Of Material	30
10	Revision history	31

List of tables

Table 1.	Supported commands.....	26
Table 2.	Bill Of Material	30
Table 3.	Document revision history	31

List of figures

Figure 1.	Evaluation board block diagram	6
Figure 2.	Top silk-screen for EK3LV02DL kit	7
Figure 3.	Board photograph	7
Figure 4.	Software installation	8
Figure 5.	Notify icon	9
Figure 6.	Driver installation through the device manager	9
Figure 7.	USB driver installation with the Hardware Update Wizard	10
Figure 8.	Virtual COM driver port assignment	11
Figure 9.	Graphical User Interface: main window	12
Figure 10.	Registers Read/Write	13
Figure 11.	EK Demo Mode window	14
Figure 12.	Threshold definition	15
Figure 13.	Single Data Acquisition	15
Figure 14.	Continuos Data "Acquisition Control"	16
Figure 15.	Plot Data and Show Data windows	16
Figure 16.	Board Axis Definition	17
Figure 17.	Bar Chart	18
Figure 18.	Inclinometer	18
Figure 19.	Axis Inclination	18
Figure 20.	Map Browsing	19
Figure 21.	Evaluation Kit Info and About window	20
Figure 22.	EK3LV02DL Lite GUI	22
Figure 23.	MEMS Pointer Demo	23
Figure 24.	Axis Orientation	24
Figure 25.	Schematic diagram for EK3LV02DL board	29

1 Evaluation kit description

The EK3LV02DL is an Evaluation Kit designed to provide the user with a complete, ready-to-use platform for the evaluation of the LIS3LV02DL, a low-power 3-Axis linear accelerometer with digital output.

The block diagram of the evaluation kit is given in [Figure 1](#).

Figure 1. Evaluation board block diagram

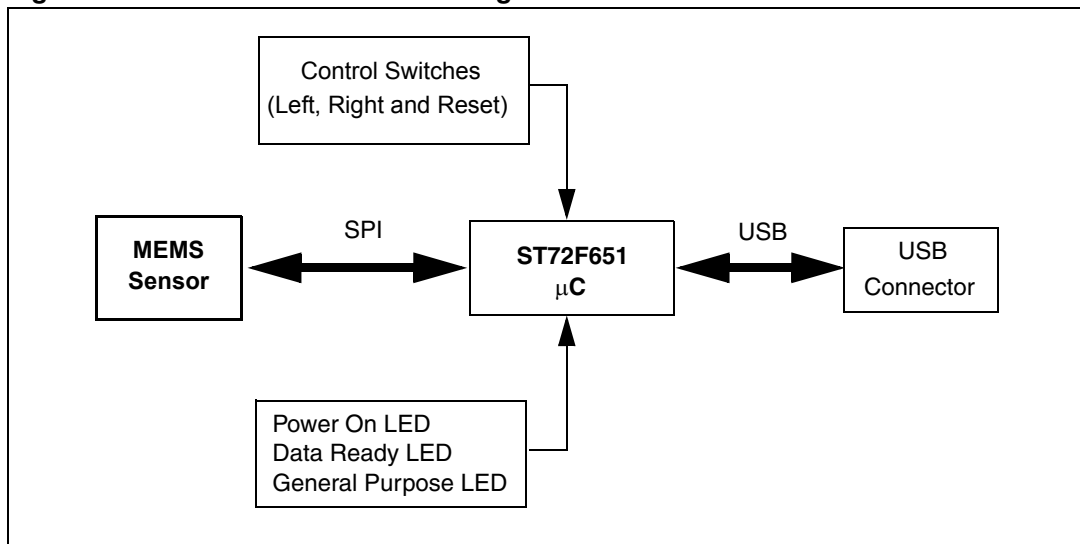

Besides the MEMS sensor, the evaluation board mounts an ST7-USB microcontroller which acts like a bridge between the sensor and the personal computer on which it is possible to run either a Graphical User Interface delivered with the kit itself or dedicated SW routines that implements customized applications.

Few switches and LED indicators are also present to control and to monitor the functionality of the board itself.

The top silk-screen of the board and the photo of the full board are shown respectively in [Figure 2](#) and in [Figure 3](#).

Figure 2. Top silk-screen for EK3LV02DL kit

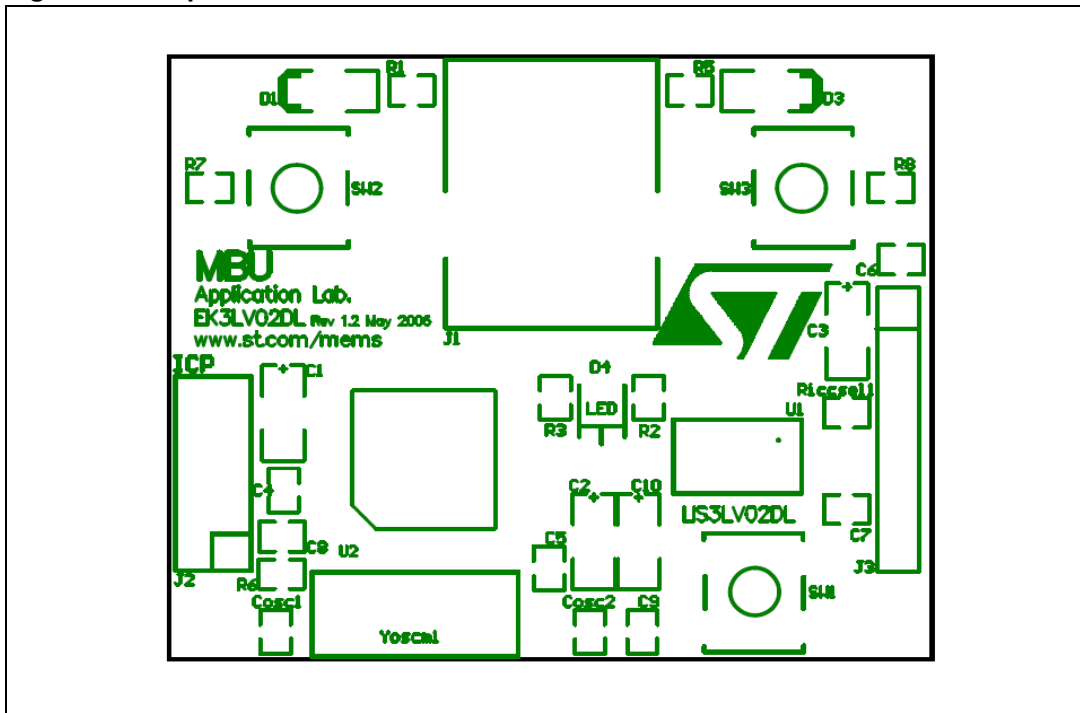
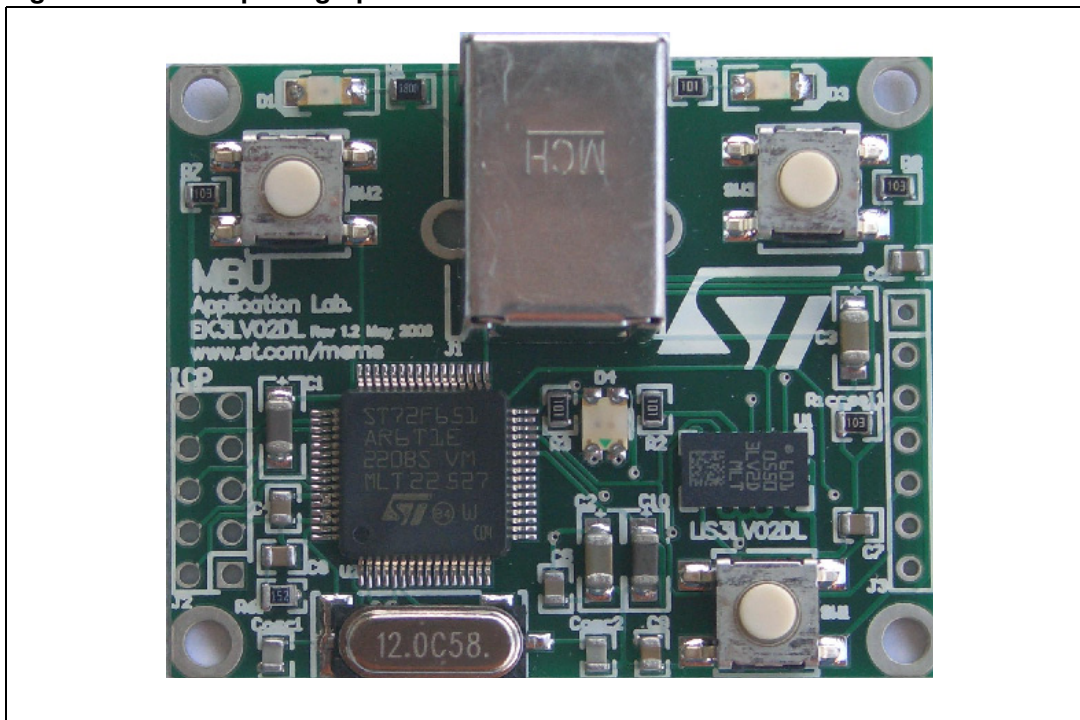

Figure 3. Board photograph



In order to operate the EK3LV02DL evaluation kit it is required the installation of a dedicated driver which is delivered onto the CD accompanying the kit itself together with a GUI interface which allows a simple interaction with the sensor itself. The steps that must be followed to install the driver and the SW are described in the following section.

2 EK3LV02DL GUI installation

The installation of Graphical User Interface (GUI) for the EK3LV02DL implies two steps:

- the installation onto the PC of the Software delivered with the evaluation kit;
- the installation of the Virtual COM driver needed to use the Evaluation Kit board.

2.1 PC system requirements

Both the hardware and software that compose the EK3LV02DL Evaluation Software Kit have been designed to operate with:

- Microsoft® Windows® XP®;
- Microsoft.NET Framework 1.1 (or higher); this software can be downloaded for free from the Microsoft web site ^(a). The installation of the “Microsoft.NET Framework” is not required when running on windows XP SP2 or higher.

2.2 Software installation

To install the SW distributed along with the EK3LV02DL evaluation kit:

1. Insert the MiniCD delivered with the Kit inside the CD-ROM drive
2. If the Autorun screen does not appear, click on **Start > Run**, enter “**D:\Autorun.exe**” and click **OK**. “**D**” represents the letter of your CD-ROM drive.
3. Click onto “Evaluation Kit SW Installation” from the “EK3LV02DL Evaluation Kit” page which appears;
4. Follow the instructions given by the Installer (*Figure 4*).

Figure 4. Software installation

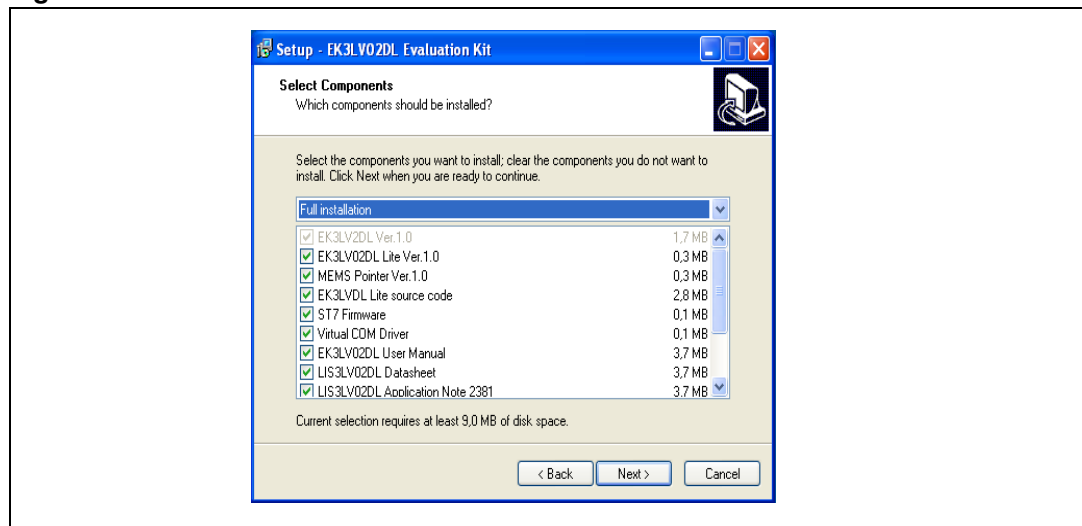

a. <http://www.microsoft.com/downloads> and search for .Net framework Redistributable Package.

2.3 Hardware installation

To install the virtual COM driver insert the Evaluation Kit board into a free USB port, look at the “Notify” icon (*Figure 5*) and then wait for “Hardware Update Wizard”.

Figure 5. Notify icon

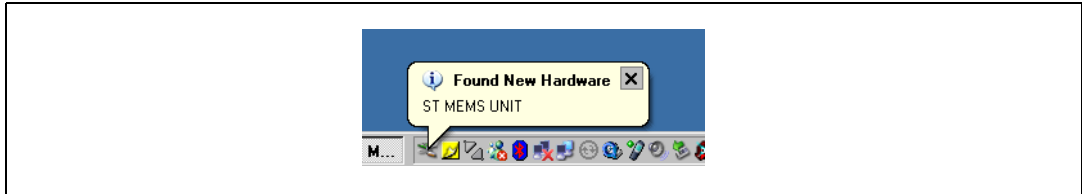

If the “Hardware Update Wizard” appears as shown in *Figure 7* then follow the instructions given in *Figure 7*; otherwise follow the instructions indicated in *Figure 6* and *Figure 7*.

Figure 6. Driver installation through the device manager

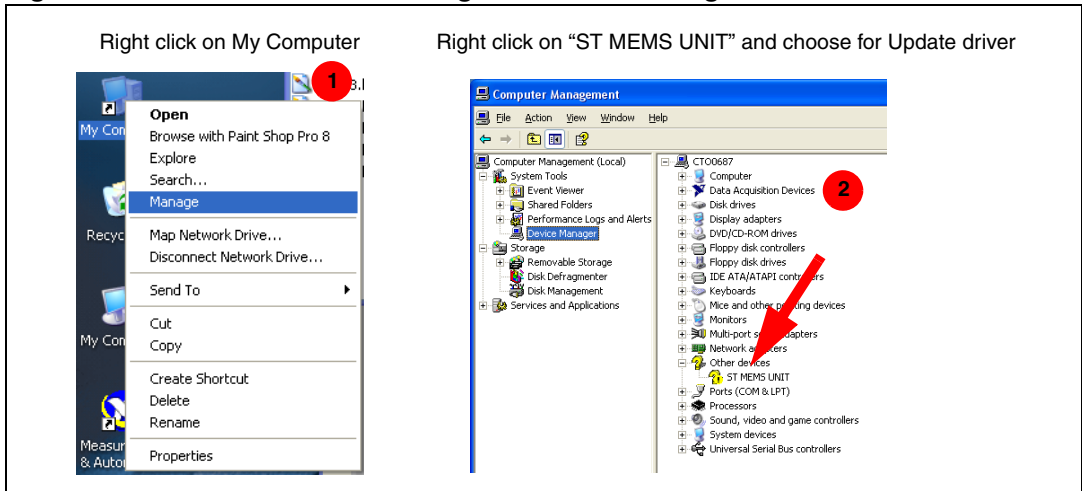
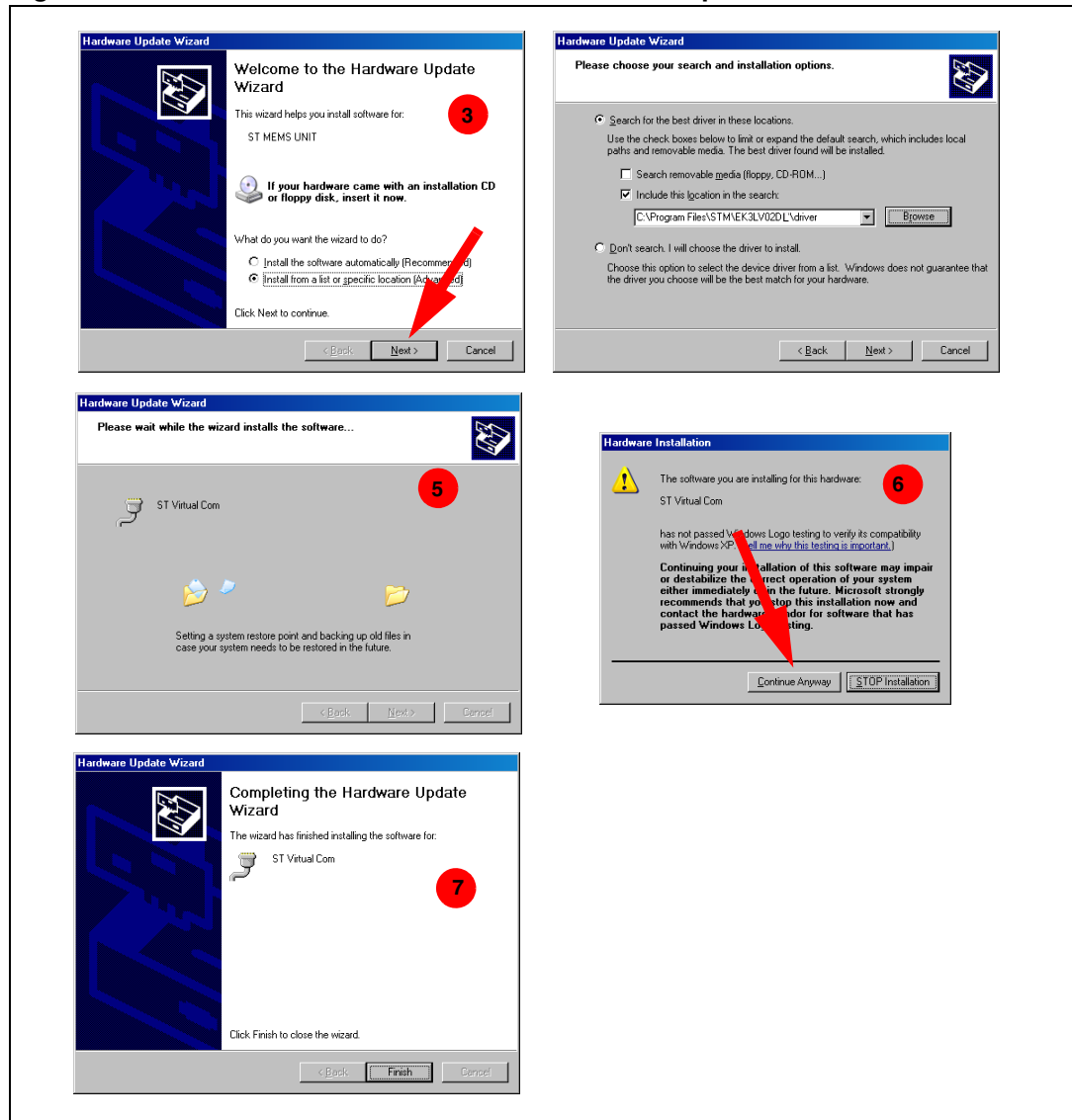
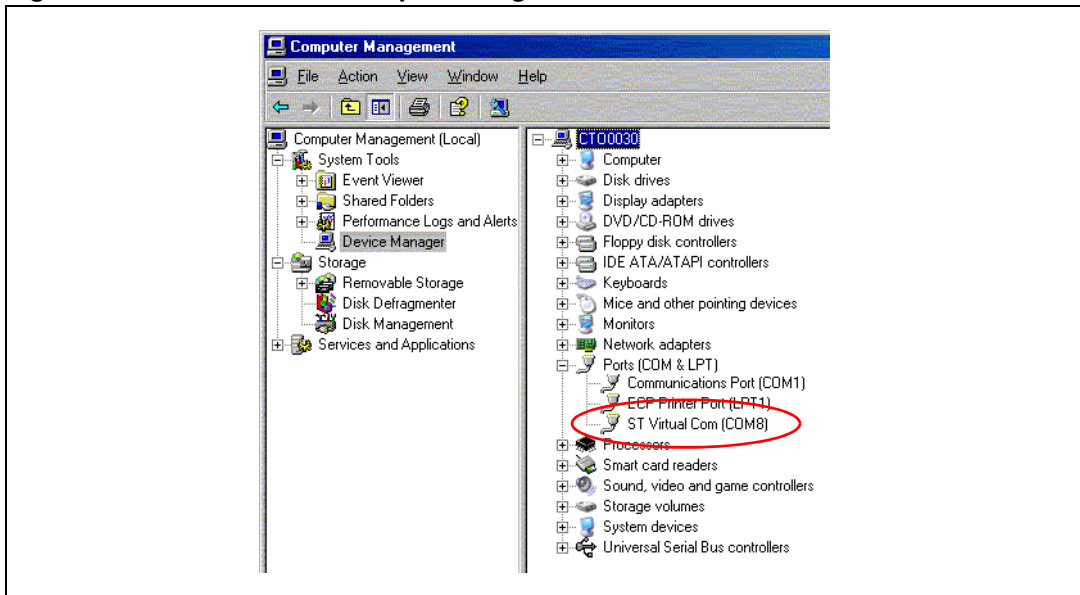

Figure 7. USB driver installation with the Hardware Update Wizard



Once the installation has finished, a COM port number will be assigned to the ST Virtual Com driver (*Figure 8*). The knowledge of this number is required to run the EK3LV02DL Evaluation Software GUI. For additional details, check section 3.1.

Figure 8. Virtual COM driver port assignment



3 Graphical User Interface

To execute the EK3LV02DL Evaluation Software Graphical User Interface:

1. Click on **Start > All Programs**
2. Select the folder **EK3LV02DL > Executables**
3. Launch the program **“EK3LV02DL Ver.1.0”**

With these operations the GUI main window will appear (*Figure 9*); the window is composed of four main sections as detailed below:

1. the graphical panel (ref1), where the data coming from the sensor are graphically represented;
2. the upper-right corner of the window (ref2), which allows to open and to close the communication port of the PC connected to the Evaluation Kit;
3. the right side, which contains the “Register Read/Write” and "Direction Detection Demo" (ref3), “Single Acquisition” (ref4) and “About EK” (ref5) blocks;
4. the bottom of the window, which handles the continuous acquisition of the acceleration data and displays them inside the graphical panel (ref6).

Figure 9. Graphical User Interface: main window

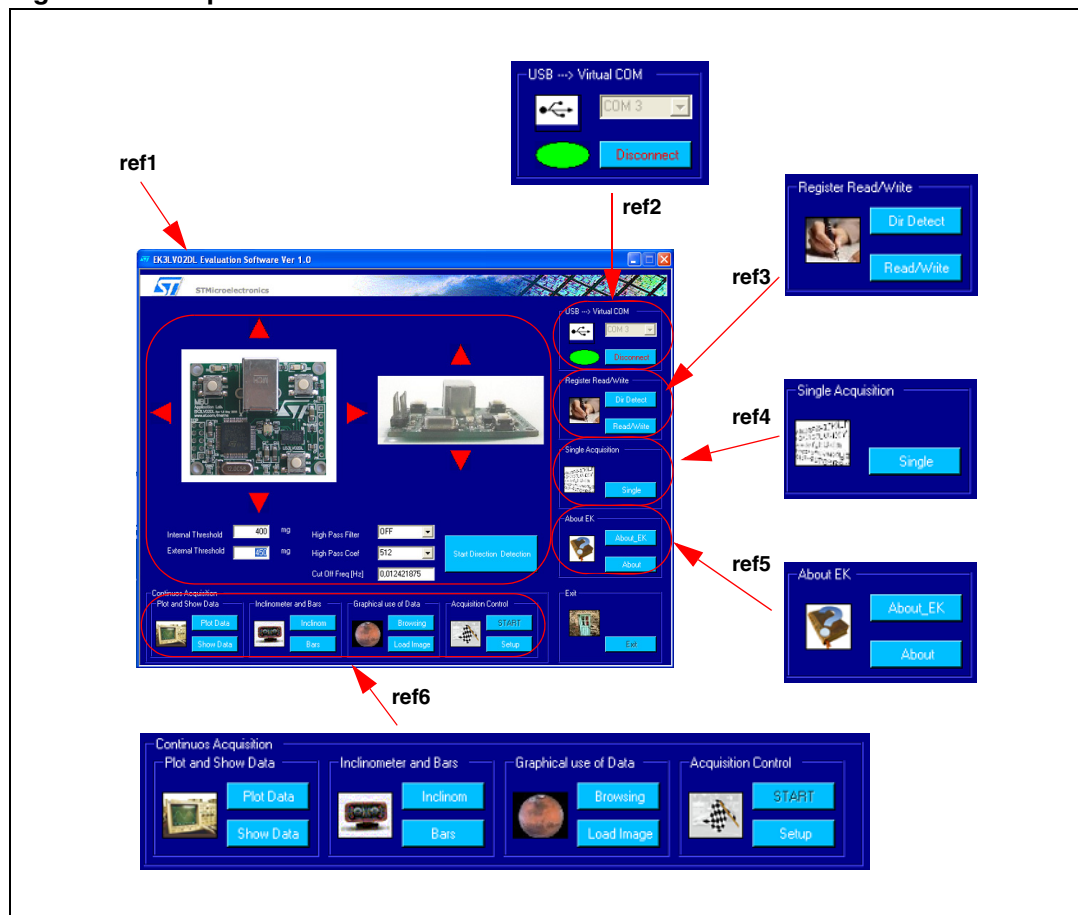

3.1 Connecting to Virtual the COM port

Before using the functions of the Evaluation Kit Software it is necessary to open the connection with the EK3LV02DL board. This is achieved through the following procedure:

1. Connect the EK3LV02DL to desired USB port;
2. In the pop-menu “USB ---> Virtual COM” choose the Virtual COM number on which the board has been mapped. For additional information on how to get this value check section 2.3.
3. Open the connection by clicking on “Connect” (Figure 9 ref2). Once this procedure is completed, the General Purpose LED of the board will switch from red to green.

Once the procedure has been completed, the user can acquire, plot and save the acceleration data measured by the sensor and he/she can access the content of the registers embedded in the device. Further details about each single function are provided in the sections hereafter.

Note: Due to Virtual COM driver communication speed limits, the maximum Output Data Rate allowed for the device is 640 Hz. Higher Output Data Rate could result in a possible data loss.

3.2 Registers Read/Write

Through the “Register Read/Write” panel (Figure 9, ref3), the user can either directly write or read the registers value inside the LIS3LV02DL device.

In particular, by clicking on the “Read/Write” button a new window appears (Figure 10).

To perform a register read out, the user must select the desired register name into “Reg Name” pop up menu (ref4) and then he/she must click on the “Read” button (ref2). The result of the reading will appear in the text box “Reg Value” (ref3).

To write a data into a register, the user must select the desired register name (ref4), choose the desired value in the text box “Reg Value” (ref3) and then click on the “Write” button (ref1). In case of read-only registers, the write button is not enabled.

Figure 10. Registers Read/Write

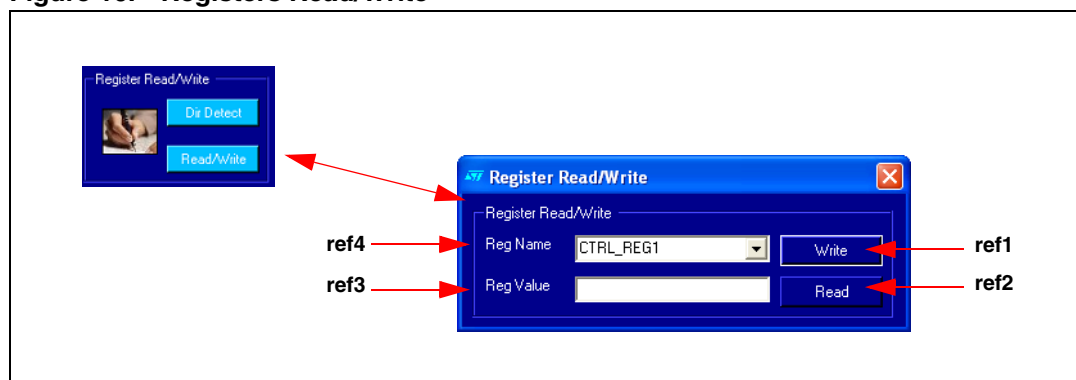

3.3 Direction detection demo

The LIS3LV02DL allows the implementation of motion-controlled functions such as gaming and terminal control while requiring reduced computational power to the application

controller. The device, in fact, may be programmed to generate an interrupt signal when a tilt is detected and to return the information of the direction in which the sensor has been tilted. With the same feature the LIS3LV02DL sensor is able to return the information about the spatial orientation of the board without requiring the reading and the further post-processing of the acceleration data.

This feature is demonstrated through the Direction Detection demo mode panel (*Figure 11*) which is activated by clicking on the “Dir Detect” button present in the main GUI window.

Figure 11. EK Demo Mode window

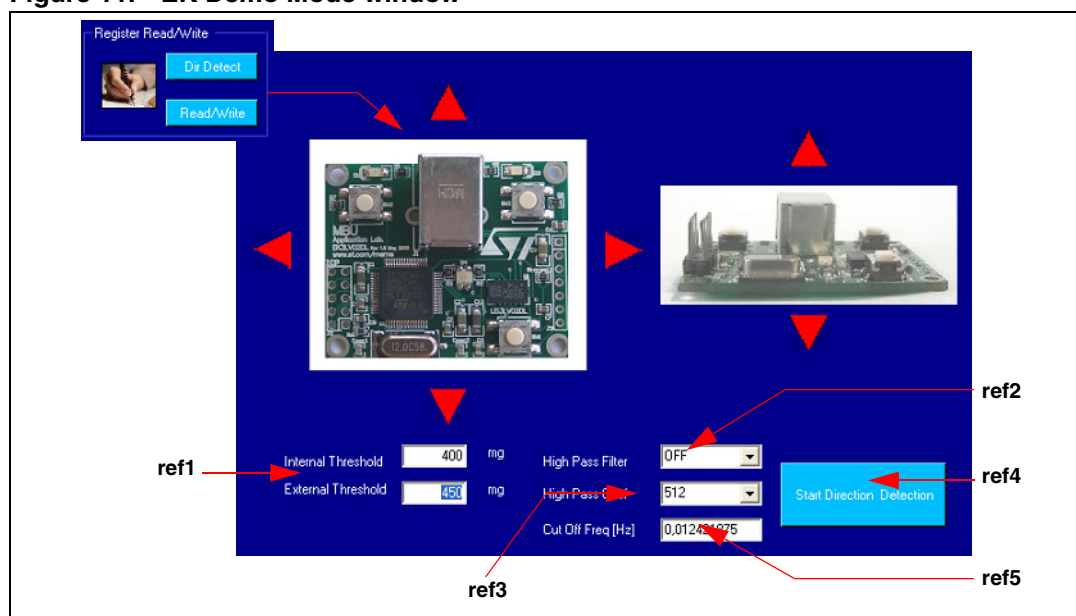

In order to configure the event which will trigger the interrupt event, the user must select the desired inner/internal and outer/external threshold (ref1), defining in this way an hysteresis region that allows to avoid false detections and/or bouncing produced for example by either spurious vibration or tremor. Whenever the inner thresholds is greater than the outer one, the hysteresis region will be null and the threshold employed to detect the tilt direction will be the outer one. A graphical representation of the internal and external thresholds is given in *Figure 12*.

Whenever the absolute value of the acceleration signal measured by the sensor either exceeds the outer threshold or returns below the inner threshold an interrupt signal will be generated and the General Purpose green LED will blink.

If the user wants to detect the orientation changes removing the DC level of the acceleration signal applied to the device (i.e. removing the gravity vector), it is possible to enable the High Pass Filter embedded inside the device by acting on the “High Pass Filter” pop-up menu (*Figure 11*, ref2). The cut-off frequency of the filter, which is shown inside the Cutoff Frequency text box (ref5), is user selectable acting on the High Pass coefficients (ref3) and on the Output Data Rate (ODR). For further details, please refer to AN2381.

To start the Direction Detection demo mode click on “Start Direction Detection” (ref4).

Figure 12. Threshold definition

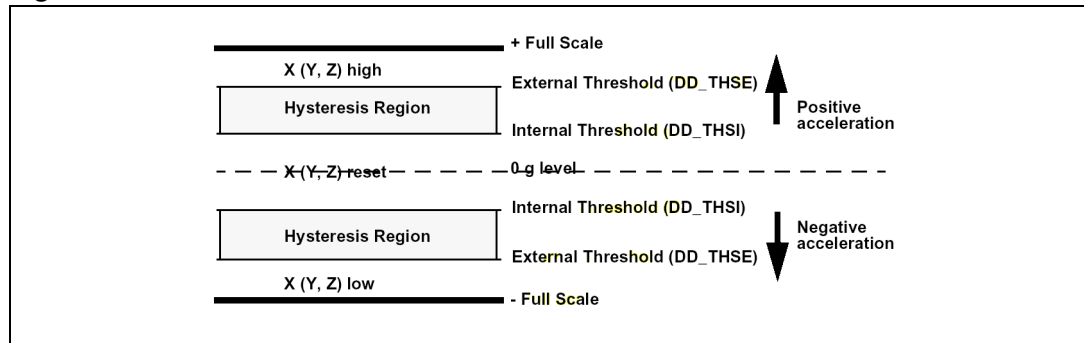

3.4 Data Acquisition

The Data Acquisition panel is split in two sections:

1. "Single Acquisition" mode (Figure 9, ref4)
2. "Continuous Acquisition" mode (Figure 9, ref6).

3.4.1 Single Acquisition mode

The "Single Acquisition" mode panel allows the user to perform the measurement of the acceleration acting on all the three axes. A single read of the acceleration data measured by the device is done by clicking on the "Acquisition" button (Figure 13, ref1).

This panel allows also to activate and to disable the Self-Test function of the device using the two radio buttons "Self Test ON" and "Self Test OFF" (Figure 13, ref2). Whenever the self-test is activated, the proof mass of the sensor is electrostatically deflected and the acceleration data measured by the sensor will exhibit a change in their DC level as specified on the datasheet of the part. This function allows to check whether the sensor is working properly without requiring any mechanical movement of the board mounting the sensor itself.

Figure 13. Single Data Acquisition

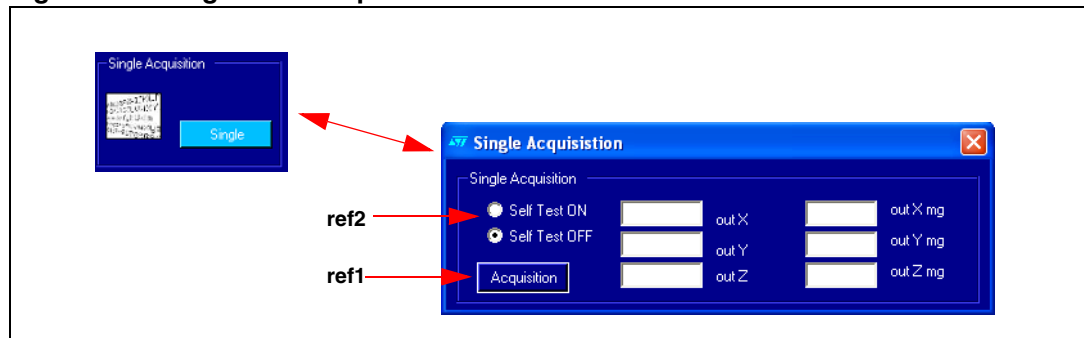

3.4.2 Continuous Acquisition mode

The section related to "Continuous Acquisition" allows the user to perform a sequence of acquisitions, to plot and to save the acquired acceleration data under different formats.

In order to start and to stop the data acquisition (and to activate the plotting of data in the afore said panels) it is necessary to push onto the "START/STOP" button (Figure 14, ref2).

Figure 14. Continuous Data “Acquisition Control”

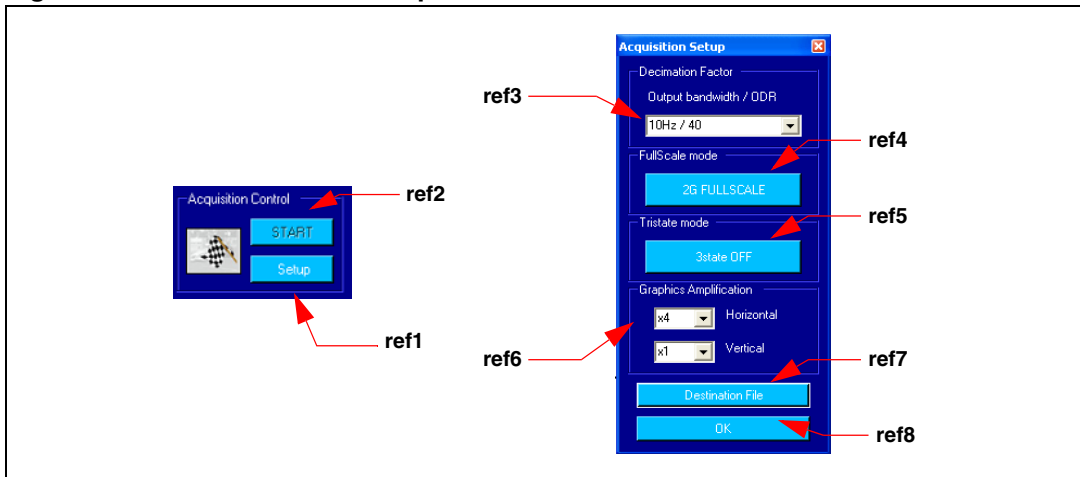

During a Continuous Acquisition Mode, the user can watch the data coming from the EK3LV02DL in different graphical windows^(b). The windows corresponding to “Plot Data” and “Show Data” are shown in [Figure 15](#).

Figure 15. Plot Data and Show Data windows

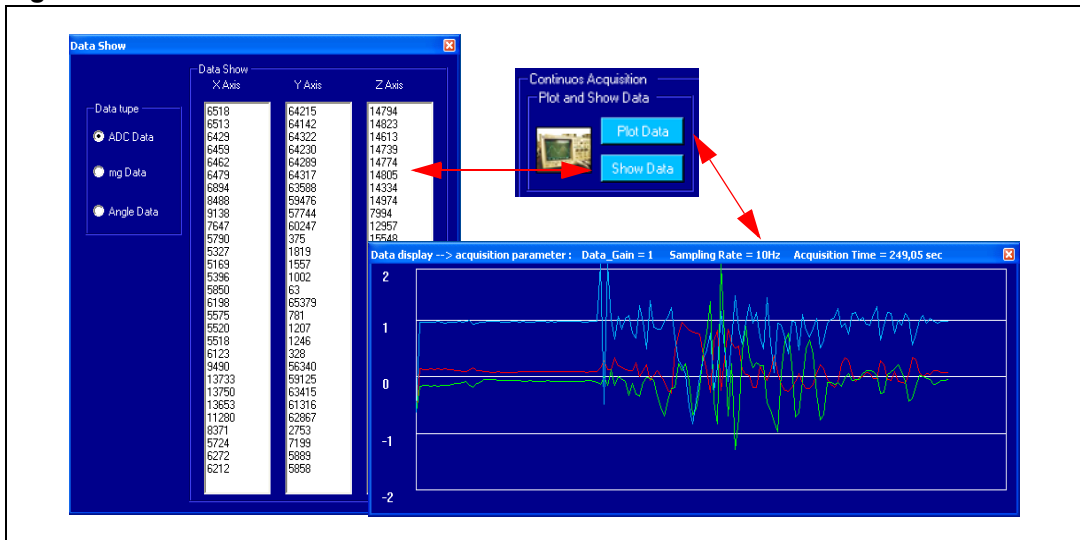

The sign of the acceleration measured by the sensor is related to the axis definition given in [Figure 16](#).

b. The computational power of the PC on which the GUI is running may affect the maximum number of windows that can be opened at the same time.

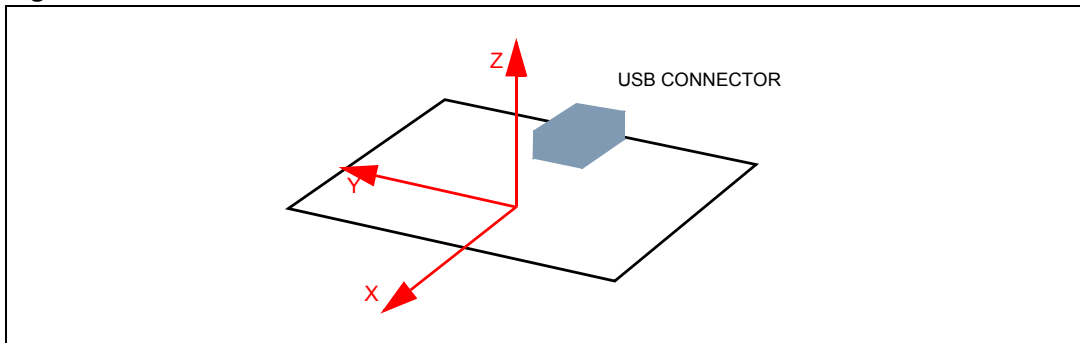
Figure 16. Board Axis Definition

Clicking on the “Setup” button ([Figure 14](#), ref1) the “Acquisition Setup” window will open. This window allows to program the output datarate of the LIS3LV02DL device. By default it is set to 40Hz (corresponding to a signal bandwidth @ -3dB of 10Hz); to modify this parameter the user has to select the desired value from the related pop up menu ([Figure 14](#), ref3).

The “Acquisition Setup” window allows to change also the device Full Scale ([Figure 14](#), ref4) and to put in tri-state mode the lines of the microcontroller SPI serial interface ([Figure 14](#), ref5). The latter feature has been implemented to guarantee to advanced users the full-control of the MEMS lines through a different source (i.e. from a separate controller).

The section related to “Graphics Amplification” ([Figure 14](#), ref5) allows to zoom the data plotted on the screen. Please notice that the horizontal and vertical gains do not change the resolution of the device; they only impact on the way in which data are shown on the screen.

Last but not least, the “Acquisition Setup” window allows the user to select the file where the acquired data values have to be stored ([Figure 14](#), ref7). In particular the file in which the data are saved reports the informations about each acquisition session and contains the acquired samples in three different fields.

In order to apply the settings defined with the “Acquisition Setup” window it is necessary to push on the “OK” button ([Figure 14](#), ref8). These settings will be used for any subsequent acquisition (until their next modification) and can not be changed while the acquisition is running.

The main panel of the GUI allows also to plot the acceleration data in three ways ([Figure 9](#), ref6):

- as a Bar Chart (*Figure 17*);

Figure 17. Bar Chart

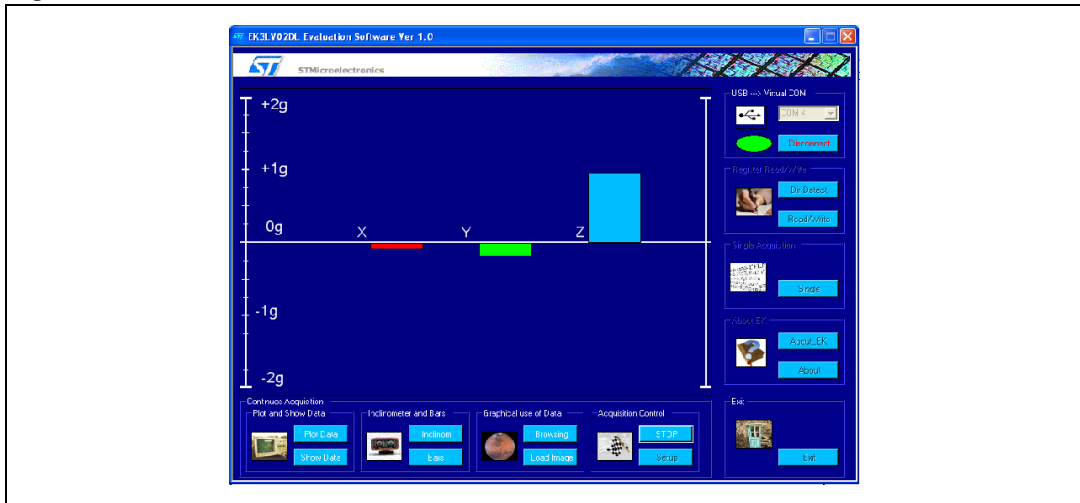

- as Inclinometers (*Figure 18*), where the inclination is related to the axes definition given in *Figure 19*;

Figure 18. Inclinometer

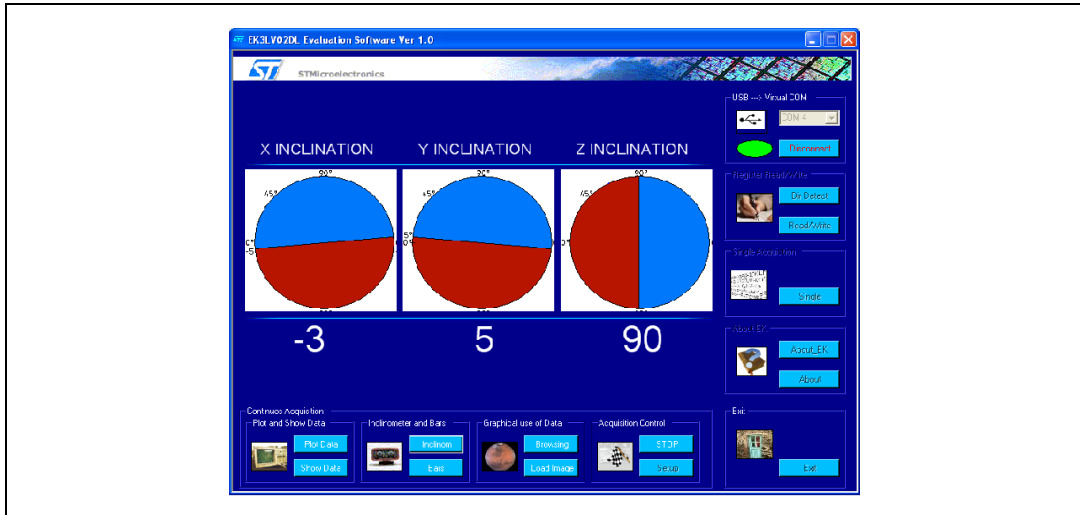
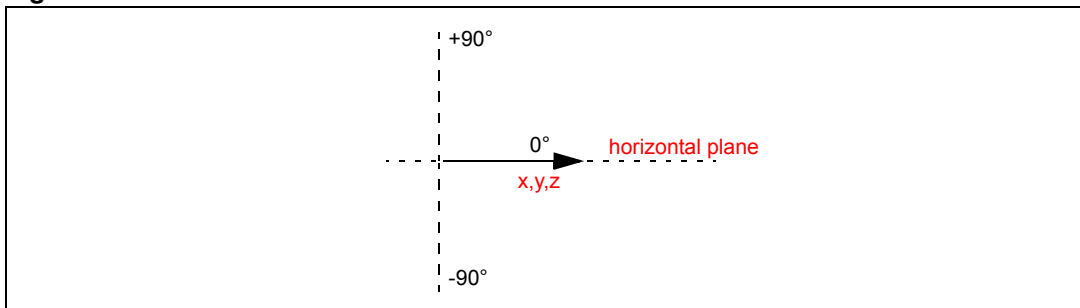
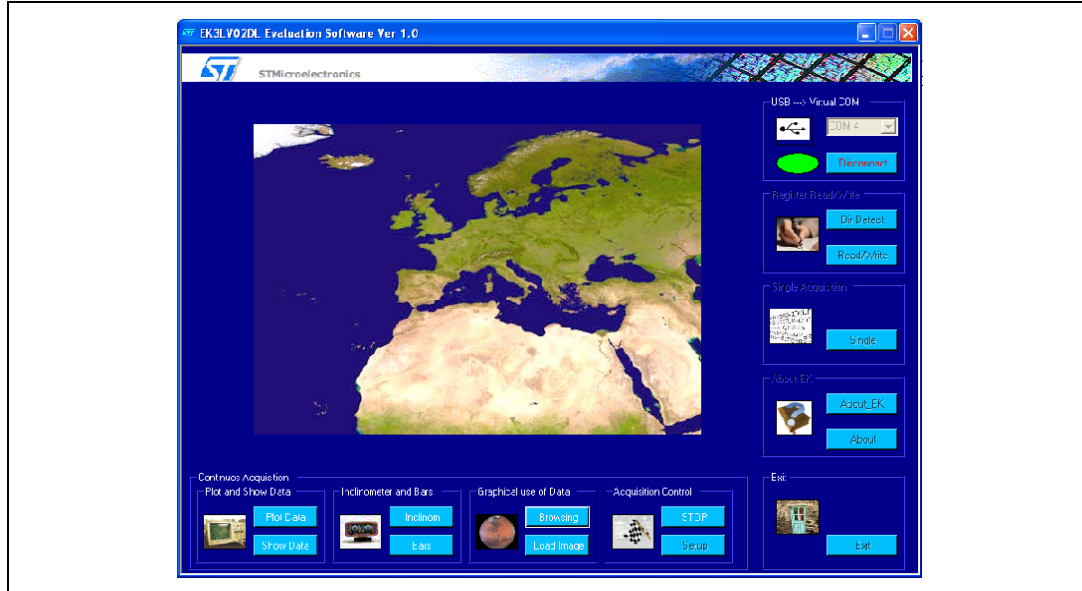

Figure 19. Axis Inclination



- to navigate through a map (Map Browsing) (*Figure 20*). The image to be shown is selected through the “Load Image” button. A map stored inside the file “mapa-mundi.jpg” is provided as an example.

Figure 20. Map Browsing



3.5 About_EK

Clicking on the “About_EK” button located into the “About EK” section (*Figure 9*, ref5) it is possible to obtain informations about the version of the GUI, about the firmware running on the Evaluation Kit and about the version MEMS accelerometer mounted onto the board.

These information are retrieved by using the buttons “Mounted Device” and “Software Version” which are shown in “Evaluation Kit Info” window (*Figure 21*). Once the information about the device are displayed on the screen it is possible to get an explanation of their meaning by moving the mouse over the different parts of the device name (LIS 3LV 02 DL). Please notice that if the connection is not working properly an error message will be shown. This feature allows to test the connection between the board and the host computer.

Figure 21. Evaluation Kit Info and About window

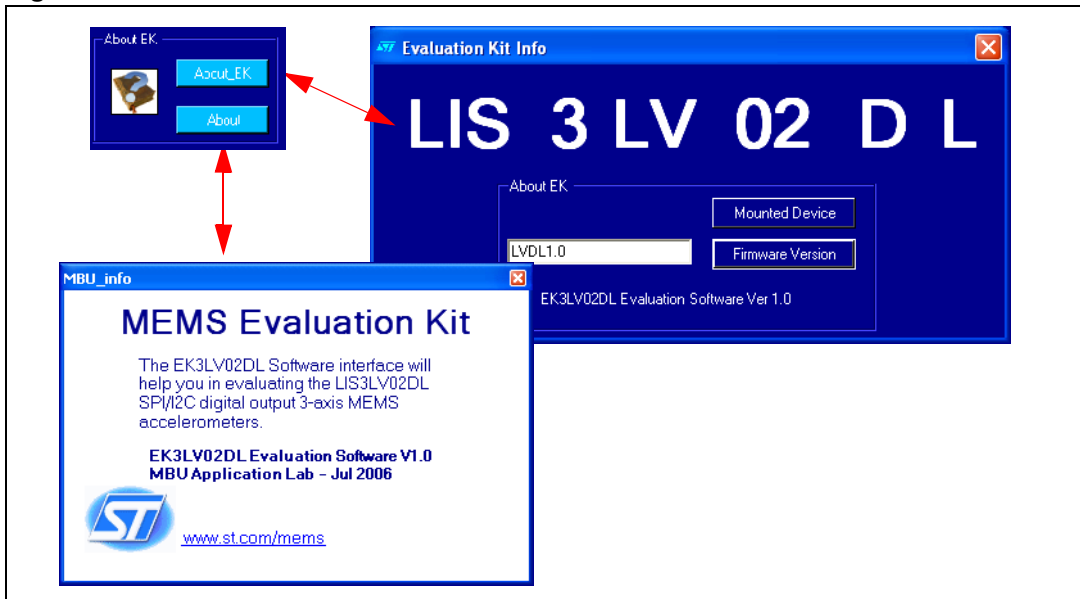

The second button (“About”) present into the “About EK” section (Figure 9, ref5) opens the “MBU_info” window which shows general informations about the software and provides the user with a direct link to the ST MEMS page.

4 Data acquisition quick start

This section describes the basic steps that have to be performed to acquire the acceleration data from the EK3LV02DL.

1. Connect the EK3L02DL to the USB port
2. Start the EK3LV02DL GUI;
3. Select the Virtual COM port and then click on the “Connect” button (*Figure 9*, ref2)
4. Select the destination file in which the acceleration data must be saved by clicking onto “Setup” (*Figure 14*, ref1) and “Destination File” (*Figure 14*, ref6) buttons;
5. Optionally select the desired decimation factor, Horizontal and Vertical gain and then click on the “OK” button (*Figure 14*, ref7).
6. Click on “Plot Data” or “Show Data” (*Figure 9*, ref6) to activate the corresponding Data Display window (*Figure 15*).
7. Click on “Browsing” button to activate the function of map browsing (*Figure 9*, ref6) and then load the desired image by clicking on “Load Image” button.
8. Click on “START” (“STOP”) button to activate (stop) the collection of data from the sensor, their saving onto file and plotting on the screen.
9. To close the application click on Disconnect and then click on Exit.

5 EK lite

The mini-CD delivered with the EK3LV02DL contains also a lite version of the previous GUI together with its source code. The source code can be found in the directory:

(\$Home)\STM\EK3LV02DL\EK3LVDL_lite

where (\$Home) represents the directory in which the SW delivered with the evaluation kit has been installed (C:\Program Files by default).

The intention is to provide to the user a guidance to the development of his/her own customized application.

The evaluation kit is started by launching the executable EK3LV02DL Lite which is contained in the **EK3LV02DQ > Executables** folder.

The graphical aspect of the GUI associated to the application is shown in [Figure 22](#).

Figure 22. EK3LV02DL Lite GUI



In order to operate the SW it is suggested to follow these instructions:

1. Connect the EK3LV02DL to the USB port
2. Start the GUI for EK3LV02DL Lite;
3. Select the Virtual COM port and then click on the “Connect” button;
4. Optionally select the destination file in which the acceleration data must be saved by clicking onto “Setup” and “Destination File” buttons;
5. Click on “Plot Data” to activate the corresponding Data Display window;
6. Click on “START” (“STOP”) button to activate (stop) the collection of data from the sensor, their saving onto file and plotting on the screen.
7. To close the application click on Disconnect and then click on Exit.

The GUI allows also the Read/Write the registers embedded in the LIS3LV02DL device mounted on the board and to perform a single read of the acceleration data measured by sensor.

6 MEMS pointer

This section describes the usage of a simple pointer application which employs the acceleration data provided by the LIS3LV02DL MEMS 3-axis linear accelerometer to control the position of a pointer on the screen of the PC. More in details, the SW provided with the kit itself allows to employ the board provided with the EK3LV02DQ Evaluation Kit as an inertial mouse where the tilt of the board is transformed into a movement of the pointer. The board emulates also the left and right buttons of the mouse.

6.1 GUI description

The GUI window (see [Figure 23](#)) may be split up into two sections: the right side contains the main controls to open the connection to the Evaluation Kit and to start/stop the data acquisition whereas the left side is dedicated to the pointer application controls.

Figure 23. MEMS Pointer Demo



6.1.1 Right Side: Main Controls

The buttons present on the right side of the GUI and their related function are described hereafter:

- Connection control: selects the COM port on which the EK board is connected to.
- Acquisition control: starts and stops the acquisition.
- Exit: exits from the MEMS Pointer Demo application.

6.1.2 Left Side: Pointer Application Controls

The controls present on the left side of the GUI and their related function are the followings:

- Left Button/Right Buttons: inform on whether the left/right button present on the Evaluation Kit is pressed.
- X/Y-Position: shows the actual x/y coordinates of the mouse pointer on the PC screen.
- X/Y-Deg: shows the tilt of the Evaluation Kit along the X and Y directions which are defined as depicted in [Figure 24](#).
- Tilt Control: allows to select the direction of the vertical displacement on the screen Vs. the direction in which the board is tilted. In particular, by selecting UP the pointer will move upward by forward tilting the Evaluation Kit. Vice versa, by selecting DOWN the pointer will move downwards whenever the board is tilted backward.
- Pointer Speed: sets the sensitivity of the pointer to the inclination of the board

Figure 24. Axis Orientation

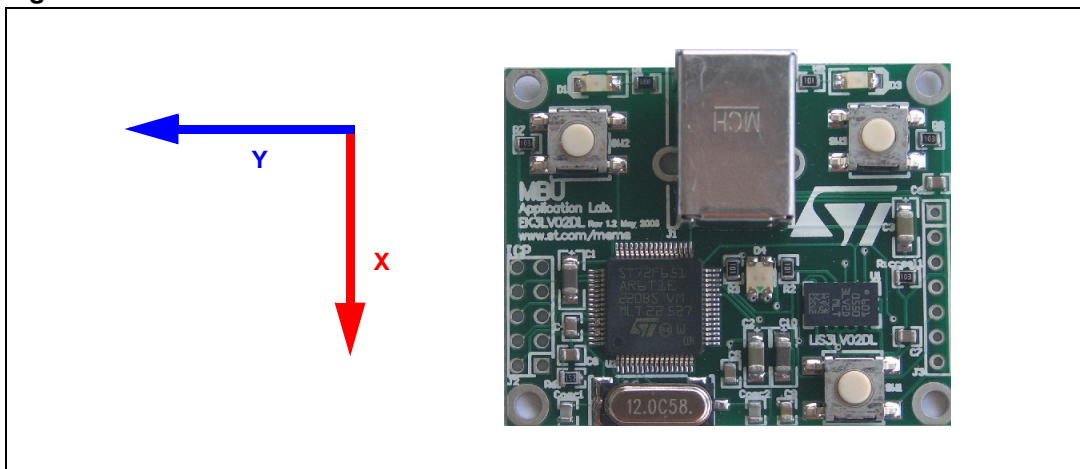

7 Supported commands

The EK3LV02DL board is equipped with a dedicated firmware which supports a set of commands that allow to control the 3-axis digital output MEMS sensor mounted on the board and to acquire the measured acceleration data.

The firmware handles also the communication between the EK board and the PC through the USB bus. Through the usage of these commands it is possible to control the 3-axis digital output MEMS sensor mounted on the board and to acquire the measured acceleration data, thus allowing the user to easy write his/her own applications which exploit the mounted accelerometer.

This section describes the commands that are supported by the firmware loaded onto the microcontroller of the EK3LV02DL Evaluation Kit.

7.1 Getting Started

Before using the commands described in the next paragraphs, the following procedure must be performed:

1. Connect the EK3LV02DL to the USB port
2. Start an appropriate software which allows to send the command through the Virtual serial port. The remaining part of this document will suppose the usage of the **“Hyper Terminal”**.
3. Create a new connection; for example name it “EK3LV02DL” and click OK;
4. In the **“Connect Using”** field select the right Virtual COM port onto which the USB port has been mapped.
5. Set the port to 115200 Bit per second, 8 Data bits, Parity None; 1 Stop bit, Flow control None and then click OK.
6. In the Hyper Terminal select **“Files > Properties > Settings”** and then click onto the **“ASCII Setup”** button.
7. Select “Send line ends with line feeds” and “Echo typed characters locally”.
8. Click onto OK button to close the **“ASCII Setup”** window.
9. Click onto OK button to close the **“Properties”** window.

Once this procedure has been completed the user can send to the EK3LV02DL the commands described in the following sections by typing the commands themselves in the “Hyper Terminal” window.

7.2 Supported Commands

The table below enlists the commands that are supported by the EK3LV02DL FW:

Table 1. Supported commands

Command	Description	Returned value
*start	Start continuous data acquisition	STxyyzs
*debug	Returns the acceleration data in readable text format	x=XX y=YY z=ZZ
*stop	Stop data acquisition	
*rAA	Register's read	RAAhDDh
*wAADD	Register's write	
*bwAA<0:7><0 1>	Single bit write	
*Zon	Force 3-state	
*Zoff	Exit from 3-state	
*dev	Device Name	3LV02DL
*ver	Firmware Version	LVDL1.0

Note: AA: register address
 DD: data
 S: service field
 XX, YY, ZZ: Acceleration data returned for the X, Y and Z axes

7.2.1 Start command

The *start command allows to start the continuous data acquisition. When this command is sent to the board it returns the acceleration data measured by the LIS3LV02DL device. The acceleration data are packed in a string composed of eight bytes: "s t Xh Xl Yh Yl Zh Zl SD". The first two bytes are always "s" and "t" which correspond to the hexadecimal values {73 74}, while "Xh" "Yh" "Zh" and "Xl" "Yl" "Zl" represent respectively the upper part and the lower-part of the acceleration data for the X, Y, Z axes.

The last byte "s" returns the information about the switches mounted on the board: in detail bit#1 and bit#0 of the "service data" correspond to the status of SW3 and SW2 on the Evaluation Kit board and they are set to 1 when the corresponding switch is pressed.

7.2.2 Debug command

The *debug command starts the continuous data acquisition. When this command is sent to the board it returns the acceleration data measured by the LIS3LV02DL device in readable text format. The values shown on the screen correspond to the content of the output data registers and are shown as hexadecimal number. A TAB is employed as separator among the different fields.

7.2.3 Stop command

The `*stop` command interrupts any acquisition session that has been started either with the `*start` or `*debug` command.

7.2.4 Registers read

The `*rAA` command allows to read the content of the registers embedded inside the LIS3LV02DL device mounted on the evaluation kit board. In details AA, expressed as hexadecimal value and written lower-case, represents the address of the register to be read. Once the read command is issued, the board will return RAAhDDh, where AA is the address sent by the user and DD is the data present in that register.

As an example, to read the CTRL_REG1 the user shall issue the command `*r20` which returns, for example, R20hC7h.

7.2.5 Registers write

The `*wAADD` command allows to write the content of the registers embedded inside the LIS3LV02DL device mounted on the evaluation kit board. In details AA and DD, expressed as hexadecimal values and written lower-case, represent respectively the address of the register and the data to be written. As an example, to write 0xC7 inside the CTRL_REG1 the user shall issue the command `*w20c7`.

7.2.6 Single bit write

With this command it is possible to set/reset a single bit inside a given register. In details the command `*bwAA<0:7><0|1>` requires to the user to specify the address AA of register in which he/she wants to change the bit, with AA expressed as hexadecimal value and written lower-case, followed by the position of the bit to be changed, integer between 0 and 7, and the value, either 0 or 1, to be associated to the specified bit.

For example, to set to 1 the FS bit present inside the CTRL_REG2 the user shall issue the command `*bw2171`.

7.2.7 Zon and Zoff

The Zon and Zoff commands are employed respectively to put into 3-state (i.e. high-impedance) and to exit (i.e. normal mode) the SPI lines of the ST7-USB microcontroller mounted on the evaluation kit. These commands allows to isolate the sensor mounted on the board from the microprocessor in case any external control (from a different micro mounted on a separate user board) is needed.

By default, when the kit is first turned on, the SPI lines are in 3-state mode and the user is required to send the command `*Zoff` to allow the communication between the sensor and the micro itself.

7.2.8 Device name

The `*dev` command retrieves the name of the device mounted on the evaluation kit connected to the PC. For the EK3LV02DL the returned value is 3LV02DL.

7.2.9 Firmware version

The `*ver` command inquires the evaluation kit and returns the version of the FW loaded on the microprocessor mounted on it.

7.3 Quick Start

This section shows the basic sequence of commands to start a data communication session and to retrieve the acceleration data from Evaluation kit.

1. Connect the EK3LV02DL to the USB port
2. Start the “**Hyper Terminal**” and configure it as described in section [7.1](#)
3. Inside the “**Hyper Terminal**” window enter the command `*Zoff` to enable the control of the SPI line from the ST7-USB microcontroller
4. Send the `*debug` command to get the acceleration data measured from the sensor
5. Send `*stop` to stop the continuous acquisition and visualization.

8 Schematic diagram

The schematic diagram of the EK3LV02DL evaluation kit is shown in [Figure 25](#).

Figure 25. Schematic diagram for EK3LV02DL board

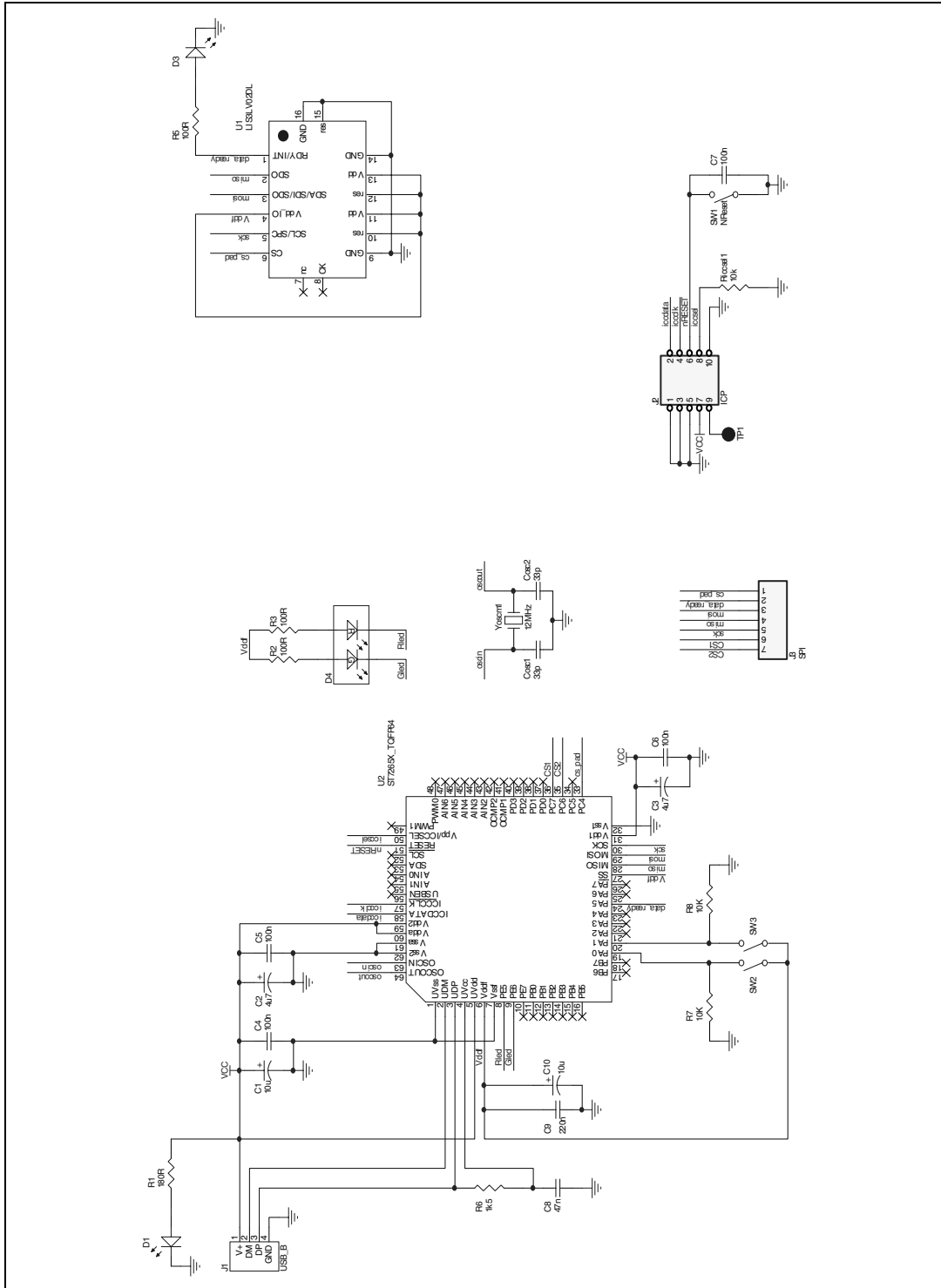

9 Bill Of Material

The Bill of Material for the EK3LV02DL evaluation kit is given in [Table 2](#).

Table 2. Bill Of Material

Designator	Description	Comment	Footprint
C1		10u	C1206_POL
C2		4u7	C1206_POL
C3		4u7	C1206_POL
C4	Capacitor	100n	0805
C5	Capacitor	100n	0805
C6	Capacitor	100n	0805
C7	Capacitor	100n	0805
C8	Capacitor	47n	0805
C9	Capacitor	220n	0805
C10		10u	C1206_POL
Cosc1	Capacitor	33p	0805
Cosc2	Capacitor	33p	0805
D1		SMD_LED red	SMD_LED
D3		SMD_LED green	SMD_LED
D4			SMD_LED_3C
J1		USB_B	USB_B
J2		ICP	HEADER_5X2_A
J3	Header, 7-Pin	SPI	HDR1X7
R1		180R	0805
R2		100R	0805
R3		100R	0805
R5		100R	0805
R6		1k5	0805
R7		10K	0805
R8		10K	0805
Riccsel1		10k	0805
SW1		NReset	SMT_Button
SW2		SMT_Button	SMT_Button
SW3		SMT_Button	SMT_Button
U1		LIS3LV02DL	TLGA_4.4x7.5x1_16L
U2		ST72F651AR6T1E	TQFP64_10x10
Yoscm1	Crystal	12MHz	OSC_SMD

10 Revision history

Table 3. Document revision history

Date	Revision	Changes
13-Sep-2006	1	Initial release.

Please Read Carefully:

Information in this document is provided solely in connection with ST products. STMicroelectronics NV and its subsidiaries ("ST") reserve the right to make changes, corrections, modifications or improvements, to this document, and the products and services described herein at any time, without notice.

All ST products are sold pursuant to ST's terms and conditions of sale.

Purchasers are solely responsible for the choice, selection and use of the ST products and services described herein, and ST assumes no liability whatsoever relating to the choice, selection or use of the ST products and services described herein.

No license, express or implied, by estoppel or otherwise, to any intellectual property rights is granted under this document. If any part of this document refers to any third party products or services it shall not be deemed a license grant by ST for the use of such third party products or services, or any intellectual property contained therein or considered as a warranty covering the use in any manner whatsoever of such third party products or services or any intellectual property contained therein.

UNLESS OTHERWISE SET FORTH IN ST'S TERMS AND CONDITIONS OF SALE ST DISCLAIMS ANY EXPRESS OR IMPLIED WARRANTY WITH RESPECT TO THE USE AND/OR SALE OF ST PRODUCTS INCLUDING WITHOUT LIMITATION IMPLIED WARRANTIES OF MERCHANTABILITY, FITNESS FOR A PARTICULAR PURPOSE (AND THEIR EQUIVALENTS UNDER THE LAWS OF ANY JURISDICTION), OR INFRINGEMENT OF ANY PATENT, COPYRIGHT OR OTHER INTELLECTUAL PROPERTY RIGHT.

UNLESS EXPRESSLY APPROVED IN WRITING BY AN AUTHORIZED ST REPRESENTATIVE, ST PRODUCTS ARE NOT RECOMMENDED, AUTHORIZED OR WARRANTED FOR USE IN MILITARY, AIR CRAFT, SPACE, LIFE SAVING, OR LIFE SUSTAINING APPLICATIONS, NOR IN PRODUCTS OR SYSTEMS WHERE FAILURE OR MALFUNCTION MAY RESULT IN PERSONAL INJURY, DEATH, OR SEVERE PROPERTY OR ENVIRONMENTAL DAMAGE. ST PRODUCTS WHICH ARE NOT SPECIFIED AS "AUTOMOTIVE GRADE" MAY ONLY BE USED IN AUTOMOTIVE APPLICATIONS AT USER'S OWN RISK.

Resale of ST products with provisions different from the statements and/or technical features set forth in this document shall immediately void any warranty granted by ST for the ST product or service described herein and shall not create or extend in any manner whatsoever, any liability of ST.

ST and the ST logo are trademarks or registered trademarks of ST in various countries.

Information in this document supersedes and replaces all information previously supplied.

The ST logo is a registered trademark of STMicroelectronics. All other names are the property of their respective owners.

© 2006 STMicroelectronics - All rights reserved

STMicroelectronics group of companies

Australia - Belgium - Brazil - Canada - China - Czech Republic - Finland - France - Germany - Hong Kong - India - Israel - Italy - Japan - Malaysia - Malta - Morocco - Singapore - Spain - Sweden - Switzerland - United Kingdom - United States of America

www.st.com