

Ultra Small Surface Mount Coaxial Connectors 1.4mm or 1.65mm Mated Height

W.FL Series

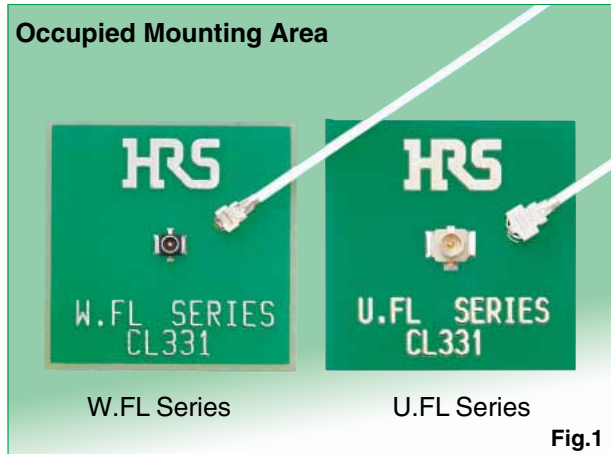
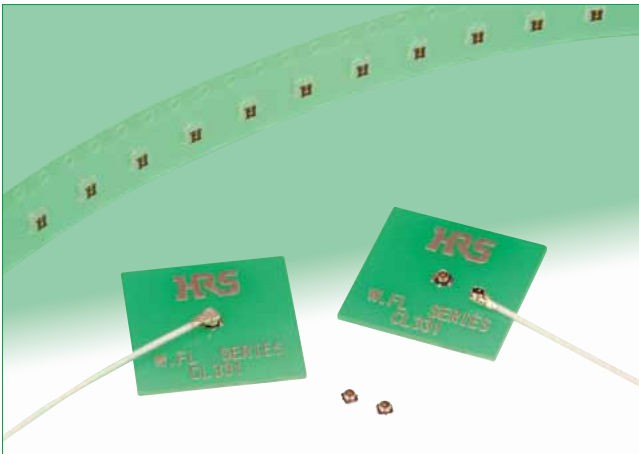

■ Features

1. Nominal mated height of 1.4mm or 1.65mm (Max. 1.55 or 1.85mm)(Fig.2)

2. Small board footprint

The W.FL Series is about 55% smaller than our U.FL Series connector and only uses 3.4mm² of PCB space. The PCB layout for the W.FL Series is the same as for W.FL2 and X.FL Series.

Note: This product is not compatible with W.FL2 Series and X.FL Series. (Fig.1)

3. Extremely light weight

Receptacle: 5.6 mg

Right-angle plug: 18.6 mg(040), 28.2mg(062)

4. Frequency range up to 6 GHz

DC to 3 GHz : V.S.W.R. of 1.3 max.

3 GHz to 6 GHz: V.S.W.R. of 1.4 max.

5. Automatic board placement

Packaged on tape-and-reel the receptacles can be placed with vacuum nozzles of the automatic placement equipment.

6. Plugs are terminated with ultra-fine coaxial (fluorinated resin insulated) cable

The use of ultra-fine coaxial (fluorinated resin insulated) cables on these connectors offer the ability to complete connections in small, confined spaces with a smooth, easy operation.

7. Simple connector mating / unmating

Use of the available mating/un-mating tools assures correct connection/disconnection of the plug and receptacle.

8. Halogen-free*(Receptacle, Plug(HF type))

*As defined by IEC61249-2-21

Br-900ppm maximum, Cl-900 ppm maximum, Cl+Br combined-1,500 ppm maximum

Mated height comparison

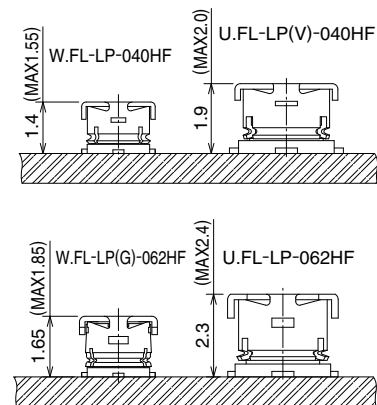

Fig.2

W. FL Plug and Receptacle

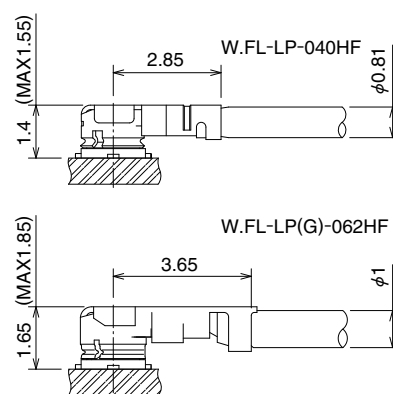
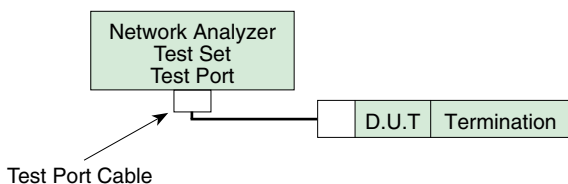

Fig.3

Specifications

Rating	Nominal characteristic impedance	50Ω	Operating temperature range	-40°C to +90°C (90% RH max.)
	Frequency range	DC to 6 GHz	Storage temperature range	-30°C to +70°C (90% RH max.)
Item	Specification		Conditions	
1. Contact resistance	Center contact : 20mΩ max. Outer contact : 10mΩ max.		10mA max.	
2. Insulation resistance	500MΩ min.		100V DC	
3. Withstanding voltage	No flashover or insulation breakdown		200V AC / 1 minute	
4. V.S.W.R.*	1.3 Max. 1.4 Max.		Up to 3 GHz 3 to 6 GHz	

*V.S.W.R. Measurement System
Measured as shown on the block diagram below.



Note1 : Measurement way of a W.FL Cable assembly (plug)
W.FL Cable assembly (plug) is measured with SMA conversion adapters mated with W.FL plugs at both ends of a 100cm coaxial cable harness

Note2 : Measurement way of a W.FL receptacle
W.FL receptacle, which is mounted on a 50Ω glass epoxy board, is measured with a SMA conversion adapter.

Materials / Finish

●Plug – right angle

Part	Material	Finish / Remarks
Shell	Phosphor bronze	Silver plated
Female center contact	Phosphor bronze	Gold plated
Insulator	PBT	Color : Gray, UL94V HB(040HF, 062HF)

●Receptacle

Part	Material	Finish / Remarks
Shell	Phosphor bronze	Silver plated
Insulator	LCP	Color : Black, UL94V-0
Male center contact	Brass	Gold plated

Cable Assembly(Plug)

W.FL-LP-040HF(06) (Applicable cable : outer diameter 0.81)

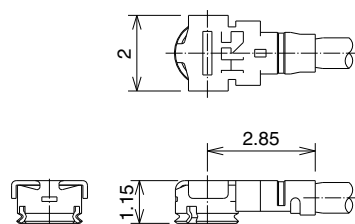

W.FL-LP-062HF(06) (Applicable cable : outer diameter 0.95)

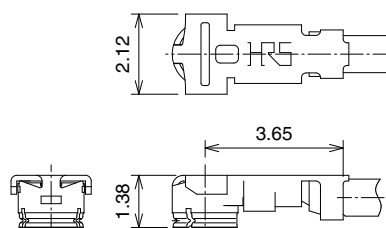

[Plugs can be ordered only as terminated cable assemblies.]

◆How to Specify Cable Assembly

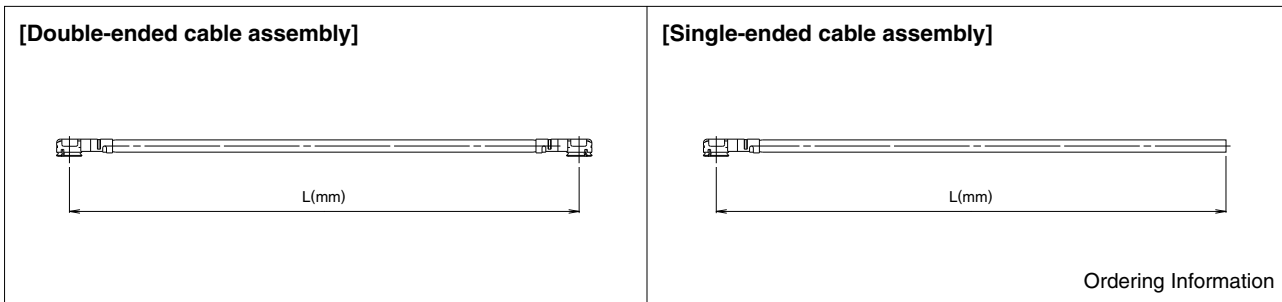

●Ordering Information

Used plug : W.FL-LP-040HF(06) (Dia. 0.81)

Double-Ended

W.FL - 2LP HF6 - 04N [] TV - A - L

① ② ③ ④ ⑤ ⑥ ⑦

Single-Ended

W.FL - LP HF6 - 04N [] TV - A - L

① ② ③ ④ ⑤ ⑥ ⑦

① Series name	W.FL
② Assembly type	LP : Single ended 2LP : Double ended
③ Environmental compliant	HF6 : Halogen-free
④ Cable type	04N : 0.81mm dia. ultra-fine coaxial cable
⑤ Cable Color	1 : White 2 : Black
⑥ Cable outer conductor	TV : Tin plated braided wire
⑦ Total length(mm)	Length(L)

Used plug:W.FL-LP(G)-062HF(06) (Dia. 0.95)

Double-Ended

W.FL - 2LPG HF6 - 062N [] D - A - L

① ② ③ ④ ⑤ ⑥ ⑦

Single-Ended

W.FL - LPG HF6 - 062N [] D - A - L

① ② ③ ④ ⑤ ⑥ ⑦

① Series name	W.FL
② Assembly type	LPG : Single ended 2LPG : Double ended
③ Environmental compliant	HF6 : Halogen-free
④ Cable type	062N : 0.95mm dia. ultra-fine coaxial cable
⑤ Cable Color	1 : Gray 2 : Black 3 : White
⑥ Cable outer conductor	D : Copper tape + Outer tin plated braided wire
⑦ Total length(mm)	Length(L)

●Standard tolerances for (L)

(L)mm	Standard tolerance(mm)
*L=35 to 200	±4
L=200 to 500	±8
L=500 to 1000	±12
L=Longer than 1000	±1.5% of (L)

Note : Minimum available length(L) is 35mm.

Receptacle

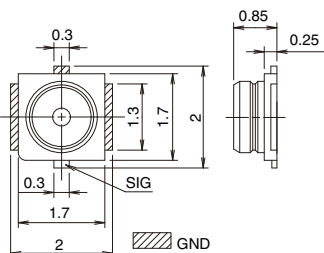
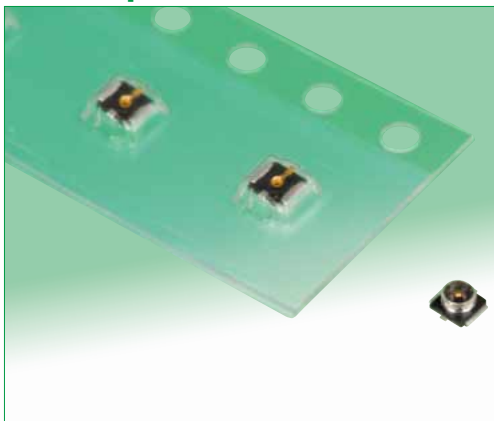

Recommended PCB mounting pattern

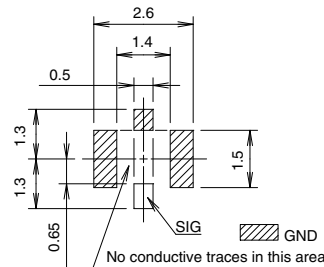

Note : The land pattern is the same as that of the X.FL, W.FL2 series connectors.

All dimensions : mm

Part No.	HRS No.	Packaging
W.FL-R-SMT-1(60)	331-0482-6 60	Reel (5,000 pcs/reel)
W.FL-R-SMT-1(80)	331-0482-6 80	Reel (10,000 pcs/reel)

Embossed Carrier Tape Dimensions(IEC 60286-3 compliant)

Embossed Carrier Tape Dimensions

(W.FL-R-SMT-1(60) 8mm pitch)

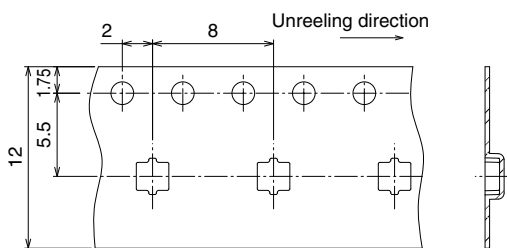

(W.FL-R-SMT-1(80) 4mm pitch)

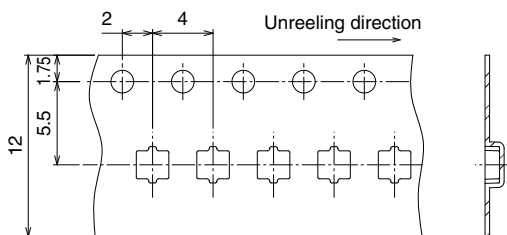

Reel Dimensions

Material : PS(Black)

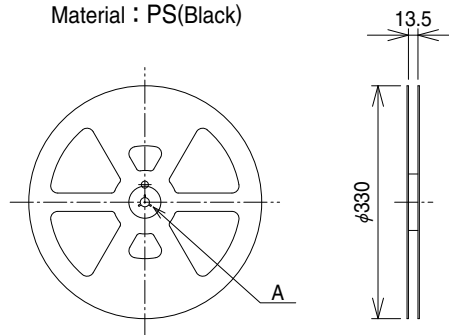

A(SCALE FREE)

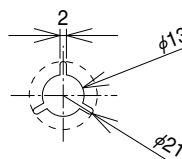

Jul.1.2022 Copyright 2022 HIROSE ELECTRIC CO., LTD. All Rights Reserved.

■ Conversion Adapters

● SMA Conversion Adapter (W.FL side jack – SMA side plug)



Note : Used for performance measurements only.
The W.FL mating side has lower retention force than the regular product when mated to the corresponding part.

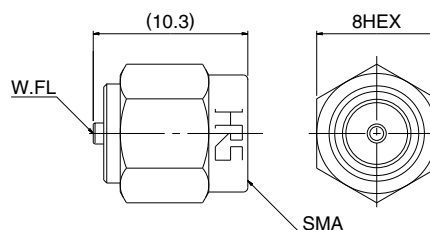

Part No.	HRS No.	Packaging
HRMP-W.FLJ(40)	311-0367-3 40	1

● SMA Conversion Adapter (W.FL side plug – SMA side jack)



Note : Used for performance measurements only.
The W.FL mating side has lower retention force than the regular product when mated to the corresponding part.

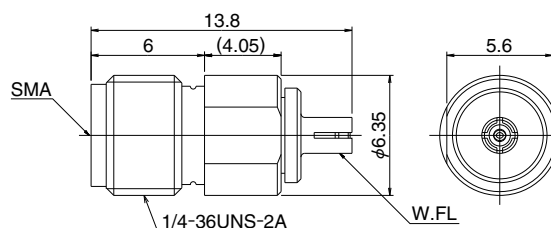

Part No.	HRS No.	Packaging
HRMJ-W.FLP(40)	311-0368-6 40	1

● SMA Conversion Adapter



Note : When mating with corresponding part (W.FL-R-SMT-1) it must be pressed down and held to make complete connection.

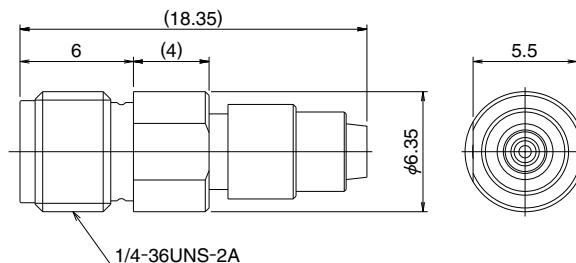

Part No.	HRS No.	Packaging
HRMJ-W.FLP-ST1(40)	311-0386-8 40	1

■ Receptacle Inspection Adapter

Used for inspecting the performance parameters of the cable assembly.

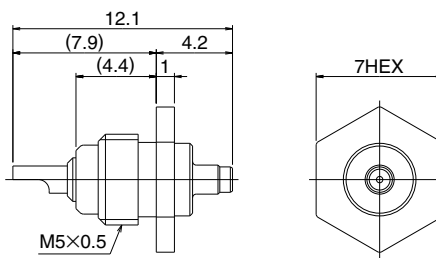
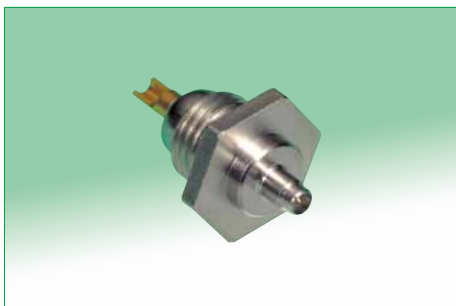

Part No.	HRS No.	Packaging
W.FL-R-1	331-0483-9	1

◆ Plug-Mating Tool

This tool is used for mating a plug.

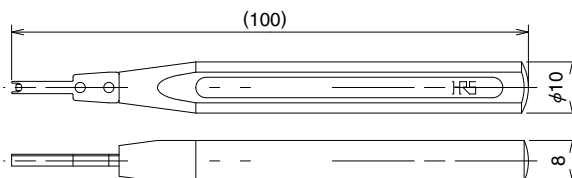

Part No.	HRS No.	Packaging
W.FL-LP-IN	331-0323-2	1

◆ Plug-Extraction Tool

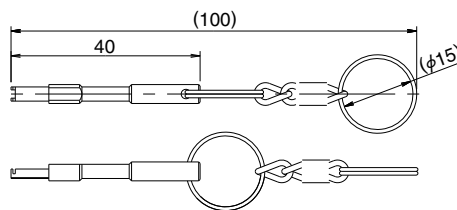
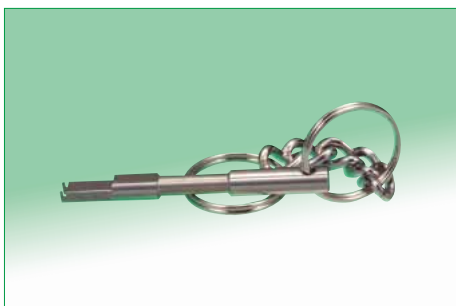

Part No.	HRS No.	Packaging
W.FL-LP-N	331-0492-0	1

◆ Precautions

1. Plug

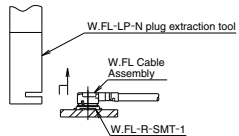
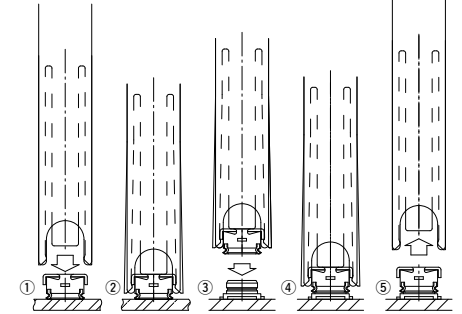
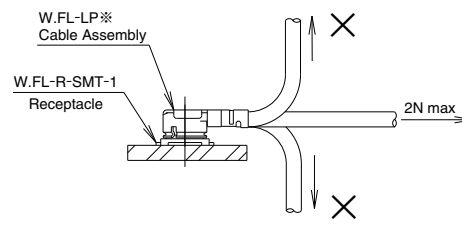
<p>(1) Mating / unmating</p>	<p>• Unmating Insert both ends of the extraction tool under the plug (from the direction opposite to the Cable termination), as shown and pull-up in the direction perpendicular to the mounting surface of the receptacle.</p> <p>● Recommended the use of the extraction tool for unmating. Any attempt of unmating by pulling on the cable may result in damage and affect the mechanical / electrical performance.</p>  <p>• Mating</p> <ol style="list-style-type: none"> Align the mating tool W.FL-LP-IN or the mating end of the tool over the plug end of the cable assembly. Firmly place the tool over the plug until it is secured in the tool. Place the plug cable assembly (held in the tool) over the corresponding receptacle. Assuring that the plug and receptacle are aligned press-down perpendicular to the mounting surface until both connectors are fully mated. Remove the mating tool by carefully pulling it up. Removal of the tool.  <p>Plug pickup → Insertion to a receptacle → Removal of the tool</p>
<p>(2) Pull forces on the cable after connectors are mated</p>	<p>After the connectors are mating, do not apply a load to the cable in excess of the values indicated in the diagram.</p> 
<p>(3) Precautions</p>	<p>Do not twist connectors excessively during mating / unmating.</p>

2. Receptacle

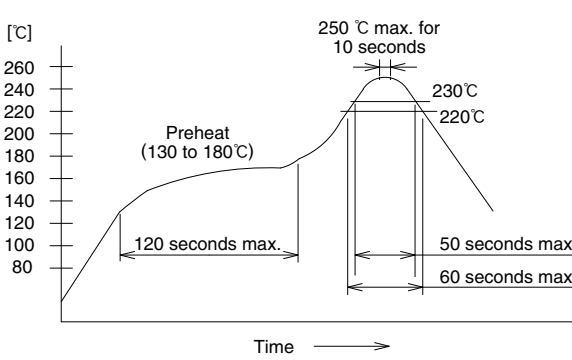
<p>(1) Recommended reflow temperature profile</p>	 <ol style="list-style-type: none"> The temperature of the printed circuit board surface temperature at the points of contact with the terminals. Reflow soldering should be performed at a printed circuit surface temperature of 250°C max. In individual applications the actual temperature may vary, depending on the solder paste type, volume / thickness and board size / thickness. Consult your solder paste and equipment manufacturer for specific recommendations.
<p>(2) Recommended metal mask thickness</p>	<p>0.1mm to 0.12mm</p>
<p>(3) Reflow cycles</p>	<p>2 times</p>

3. Operating environment and storage conditions

<p>(1) Operating environment</p>	<p>The connectors are not designed to operate in the following environments:</p> <ul style="list-style-type: none"> Exposed to a excessive amounts of fine particles and dust Regions and places having a high density of sulfur dioxide, hydrogen sulfide, nitrogen dioxide or other corrosive gasses. Environments having large rapid variations in temperature.
<p>(2) Storage conditions - Receptacle</p>	<p>Store in the Hirose Electric packaging. Temperature : -10 to +40°C, Humidity : 85% max. Use within 6 months of delivery. Receptacles for which the storage period has elapsed must be tested for solderability to the PC board mounting surface.</p>

Jul.1.2022 Copyright 2022 HIROSE ELECTRIC CO., LTD. All Rights Reserved.

USA:

HIROSE ELECTRIC (U.S.A.), INC. HEADQUARTERS CHICAGO OFFICE
2300 Warrenville Road, Suite 150,
Downers Grove, IL 60515
Phone : +1-630-282-6700
<http://www.hirose.com/us/>

USA:

HIROSE ELECTRIC (U.S.A.), INC. SAN JOSE OFFICE
2841 Junction Ave, Suite 200
San Jose, CA. 95134
Phone : +1-408-253-9640
Fax : +1-408-253-9641
<http://www.hirose.com/us/>

USA:

HIROSE ELECTRIC (U.S.A.), INC. DETROIT OFFICE (AUTOMOTIVE)
17197 N. Laurel Park Drive, Suite 253,
Livonia, MI 48152
Phone : +1-734-542-9963
Fax : +1-734-542-9964
<http://www.hirose.com/us/>

USA:

HIROSE ELECTRIC (U.S.A.), INC. BOSTON OFFICE
300 Brickstone Square Suite 201,
Andover, MA 01810
Phone : +1-978-662-5255

THE NETHERLANDS:

HIROSE ELECTRIC EUROPE B.V.
Hogehillweg #8 1101 CC Amsterdam Z-0
Phone : +31-20-6557460
Fax : +31-20-6557469
<http://www.hirose.com/eu/>

GERMANY:

HIROSE ELECTRIC EUROPE B.V. GERMAN BRANCH
Schoenbergstr. 20, 73760 ostfildern
Phone : +49-711-456002-1
Fax : +49-711-456002-299
<http://www.hirose.com/eu/>

GERMANY:

HIROSE ELECTRIC EUROPE B.V. NUREMBERG OFFICE
Neumeyerstrasse 22-26, 90411 Nurnberg
Phone : +49-911 32 68 89 63
Fax : +49-911 32 68 89 69
<http://www.hirose.com/eu/>

GERMANY:

HIROSE ELECTRIC EUROPE B.V. HANOVER OFFICE
Bayernstr. 3, Haus C 30855 Langenhagen, Germany
Phone : +49-511 97 82 61 30
Fax : +49-511 97 82 61 35
<http://www.hirose.com/eu/>

FRANCE:

HIROSE ELECTRIC EUROPE B.V. PARIS OFFICE
130 Avenue Joseph Kessel, Bat E, 78960
Voisins le Bretonneux, France
Phone : +33-1-85764886
Fax : +33-1-85764823
<http://www.hirose.com/eu/>

UNITED KINGDOM:

HIROSE ELECTRIC EUROPE BV (UK BRANCH)
4 Newton Court, Kelvin Drive, Knowlhill,
Milton Keynes, MK5 8NH
Phone : +44-1908 202050
Fax : +44-1908 202058
<http://www.hirose.com/eu/>

CHINA:

HIROSE ELECTRIC (CHINA) CO., LTD. (SHANGHAI, HEADQUARTERS)
18, Enterprise Center Tower 2, 209# Gong He
Road, Jing'an District, Shanghai, CHINA 200070
Phone : +86-21-6391-3355
Fax : +86-21-6391-3335
<http://www.hirose.com/cn/>

CHINA:

HIROSE ELECTRIC (CHINA) CO.,LTD. BEIJING BRANCH
A1001, Ocean International Center, Building 56# East 4th
Ring Middle Road, ChaoYang District, Beijing, 100025
Phone : +86-10-5165-9332
Fax : +86-10-5908-1381
<http://www.hirose.com/cn/>

CHINA:

HIROSE ELECTRIC (CHINA) CO., LTD. SHENZHEN BRANCH
Room 09-13, 19/F, Office Tower Shun Hing Square, Di Wang Commercial Centre,
5002 Shen Nan Dong Road, Shenzhen City, Guangdong Province, 518008
Phone : +86-755-8207-0851
Fax : +86-755-8207-0873
<http://www.hirose.com/cn/>

HONG KONG:

HIROSE ELECTRIC HONGKONG TRADING CO., LTD.
Room 1001, West Wing, Tsim Sha Tsui Centre, 66
Mody Road, Tsim Sha Tsui East, Kowloon, Hong Kong
Phone : +852-2803-5338
Fax : +852-2591-6560
<http://www.hirose.com/hk/>

TAIWAN:

HIROSE ELECTRIC TAIWAN CO., LTD.
103 8F, No.87, Zhengzhou Rd., Taipei
Phone : +886-2-2555-7377
Fax : +886-2-2555-7355
<http://www.hirose.com/tw/>

KOREA:

HIROSE KOREA CO.,LTD.
143, Gongdan 1-daero, Siheung-si,
Gyeonggi-do, 15084, Korea
Phone : +82-31-496-7000
Fax : +82-31-496-7100
<http://www.hirose.co.kr/>

SINGAPORE:

HIROSE ELECTRIC SINGAPORE PTE. LTD.
03, Anson Road, #20-01, Springleaf Tower,
Singapore 079909
Phone : +65-6324-6113
Fax : +65-6324-6123
<http://www.hirose.com/sg/>

INDIA:

HIROSE ELECTRIC SINGAPORE PTE. LTD. DELHI LIAISON OFFICE
Office NO.552, Regus-Green Boulevard, Level5, Tower C,
Sec62, Plot B-9A, Block B, Noida, 201301, Uttar Pradesh, India
Phone : +91-12-660-8018
Fax : +91-120-4804949
<http://www.hirose.com/sg/>

INDIA:

HIROSE ELECTRIC SINGAPORE PTE. LTD. BANGALORE LIAISON OFFICE
Unit No-403, 4th Floor, No-84, Barton Centre, Mahatma
Gandhi (MG) Road, Bangalore 560 001, Karnataka, India
Phone : +91-80-4120 1907
Fax : +91-80-4120 9908
<http://www.hirose.com/sg/>

MALAYSIA:

PENANG REPRESENTATIVE OFFICE
73-3-1, Ideal@The One, Jalan Mahsuri, Bayan
Lepas Penang, 11950, Malaysia
Phone : +604-648-5536
<http://www.hirose.com/sg/>

THAILAND:

BANGKOK OFFICE (REPRESENTATIVE OFFICE)
Unit 4703, 47th FL., 1 Empire Tower, South Sathorn
Road, Yannawa, Sathorn, Bangkok 10120 Thailand
Phone : +66-2-686-1255
Fax : +66-2-686-3433
<http://www.hirose.com/sg/>



HIROSE ELECTRIC CO.,LTD.

2-6-3,Nakagawa Chuoh,Tsuzuki-Ku,Yokohama-Shi 224-8540,JAPAN
TEL: +81-45-620-3526 Fax: +81-45-591-3726
<http://www.hirose.com>
<http://www.hirose-connectors.com>