

# Fast Switching SCR T72H\_35

350A Avg.  
(550 RMS)  
Up to 1200 Volts  
10-50  $\mu$ s

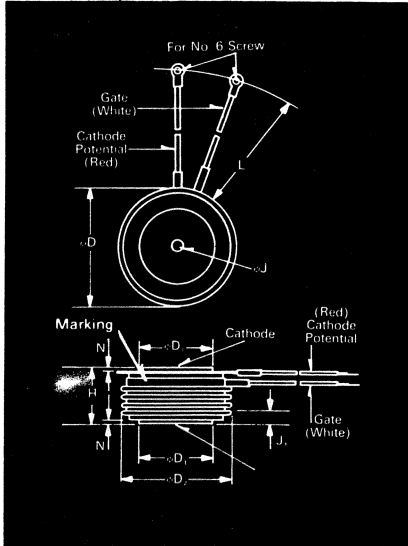

Symbol	Inches		Millimeters	
	Min.	Max.	Min.	Max.
$\phi D$	2.250	2.290	57.15	58.17
$\phi D_1$	1.333	1.343	33.86	34.11
$\phi D_2$	2.030	2.090	51.56	53.09
H	1.020	1.060	25.91	26.92
$\phi J$	.135	.145	3.43	3.68
$J_1$	.075	.090	1.91	2.29
L	7.75	8.50	196.85	215.90
N	.040		1.02	

Creep Distance—1.00 in. min. (25.40 mm).  
Strike Distance—.69 in. min. (17.53 mm).  
(In accordance with NEMA standards.)  
Finish—Nickel Plate.  
Approx. Weight—8 oz. (227 g).  
1. Dimension "H" is a clamped dimension.

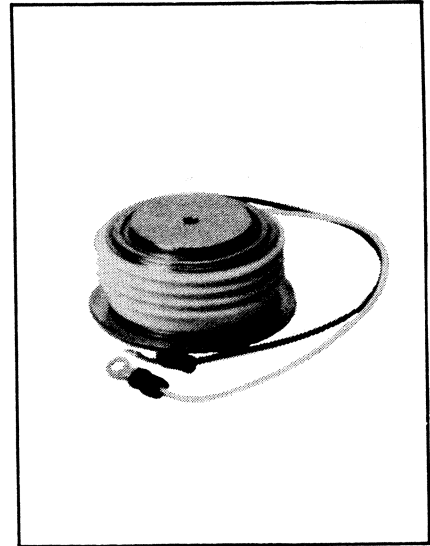

## T72 Outline

### Features:

- Interdigitated, di/namic Gate structure
- Hard Commutation Turn-Off
- Forward Blocking Voltage Capabilities to 1200 Volts
- Low Switching Losses at High Frequency
- Soft Commutation (Feedback Diode) Testing Available
- High di/dt with softgate control

### Applications:

- Induction Heating
- Transportation
- Inverters
- Crowbars
- Cycloconverters

## Ordering Information

Type	Voltage		Current		Turn-off		Gate current		Leads	
	VDRM and VRRM (V)	Code	IT(av) (A)	Code	tq usec	Code	IGT (ma)	Code	Case	Code
T72H	100	01	350	35	10	5	150	4	T72	DN
	200	02			15	7				
	300	03			20	6				
	400	04			25	8				
	500	05			30	5				
	600	06			40	4				
	700	07			50	3				
	800	08			100	K				
	900	09								
	1000	10								
	1100	11								
	1200	12								
	1000	10								

## Example

Obtain optimum device performance for your application by selecting proper Order Code.

Type T72H rated at 350 A average with VDRM = 1000V, IGT = 150 ma, tq = 30  $\mu$ sec max. and leads—order as:

Type	Voltage	Current	Turn Off	Gate Current	Leads
T 7 2 H	1 0	3 5	5	4	D N

**350A Avg.  
(550 RMS)  
Up to 1200 Volts  
10-50  $\mu$ s**

**Fast Switching  
SCR  
T72H\_35**

**Voltage** ①

**Blocking State Maximums** ( $T_J = 125^\circ\text{C}$ )

Repetitive peak forward blocking voltage, V ...	$V_{DRM}$
Repetitive peak reverse voltage, V ...	$V_{RRM}$
Non-repetitive transient peak reverse voltage, $t \leq 5.0$ msec, V ...	$V_{RSM}$
Forward leakage current, mA peak ...	$I_{DRM}$
Reverse leakage current, mA peak ...	$I_{RRM}$

100	200	300	400	500	600	700	800	900	1000	1100	1200	
100	200	300	400	500	600	700	800	900	1000	1100	1200	
200	300	400	500	600	700	800	900	1000	1100	1200	1300	
							35					
							35					

**Current**

**Conducting State Maximums**  
( $T_J = 125^\circ\text{C}$ )

RMS forward current, A ...	$I_{T(rms)}$	550
Ave. forward current, A ...	$I_{T(av)}$	350
One-half cycle surge current②, A ...	$I_{TSM}$	7000
3 cycle surge current③, A ...	$I_{TSM}$	5040
10 cycle surge current③, A ...	$I_{TSM}$	4340
$I^2t$ for fusing (for times $\geq 8.3$ ms) A <sup>2</sup> sec.	$I^2t$	205,000
Forward voltage drop at $I_{TM} = 1500A$ and $T_J = 25^\circ\text{C}$ , V ...	$V_{TM}$	3.15
Min. repetitive $di/dt$ ④⑤ A/ $\mu$ sec ...	$di/dt$	500

**T72H\_35**

**Switching**

( $T_J = 25^\circ\text{C}$ )

Max. turn-off time,  $I_T = 1000A$ ,  $T_J = 125^\circ\text{C}$

$t_p = 100$ $\mu$ sec. $dirR/dt = 50$ A/ $\mu$ sec., reapplied $dv/dt =$ 200 V/ $\mu$ sec. linear to 0.8 $V_{DRM}$ , $\mu$ sec. ⑥⑦	$t_q$	10 to 50
Typ. delay time, $I_{TM} = 1000A$ $T_D = .8 V_{DRM}$ ⑧, $\mu$ sec	$t_d$	.5

Min. critical $dv/dt$ exponential to .8 $V_{DRM}$ , $T_J = 125^\circ\text{C}$ , V/ $\mu$ sec ⑨⑩	$dv/dt$	300
--	---------	-----

Min. $di/dt$ , non-repetitive, A/ $\mu$ sec ⑪⑫	$di/dt$	1200
--	---------	------

**Gate**

**Maximum Parameters**  
( $T_J = 25^\circ\text{C}$ )

Gate current to trigger at $V_D = 12V$ , mA	$I_{GT}$	150
Gate voltage to trigger at $V_D = 12V$ , V ...	$V_{GT}$	3
Non-triggering gate voltage, $T_J = 125^\circ\text{C}$ , and rated $V_{DRM}$ , V ...	$V_{GDM}$	.25
Peak forward gate current, A ...	$I_{GTM}$	4
Peak reverse gate voltage, V ...	$V_{GRM}$	5
Peak gate power, Watts ...	$P_{GM}$	16
Average gate power, Watts ...	$P_{G(av)}$	3

**Thermal and Mechanical**

Min., Max. oper. junction temp., $^\circ\text{C}$ ...	$T_J$	-40 to +125
Min., Max. storage temp., $^\circ\text{C}$ ...	$T_{stg}$	-40 to +150
Max. mounting force, lb. ... ⑬		2000 to 2400
Thermal resistance⑭, double- side cooling, junction to case, $^\circ\text{C}/\text{Watt}$ ...	$R_{\theta JC}$	.06
Case to sink, lubricated, $^\circ\text{C}/\text{Watt}$ ...	$R_{\theta CS}$	.02

- ① Consult recommended mounting procedures.
- ② Applies for zero or negative gate bias.
- ③ Per JEDEC RS-397, 5.2.2.1.
- ④ With recommended gate drive.
- ⑤ Higher  $dv/dt$  ratings available, consult factory.
- ⑥ Per JEDEC standard RS-397, 5.2.2.6.
- ⑦ For operation with antiparallel diode, consult factory.

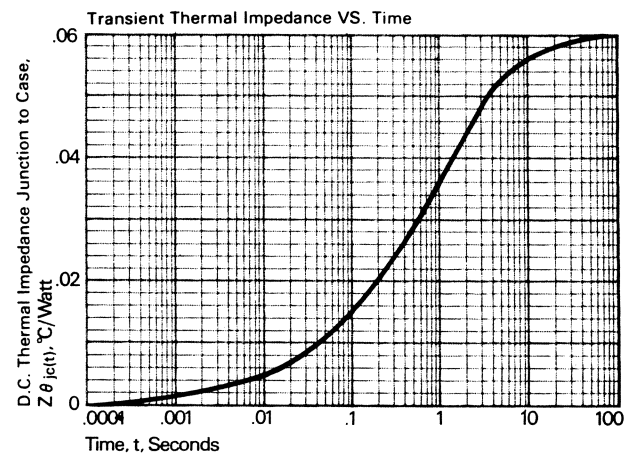
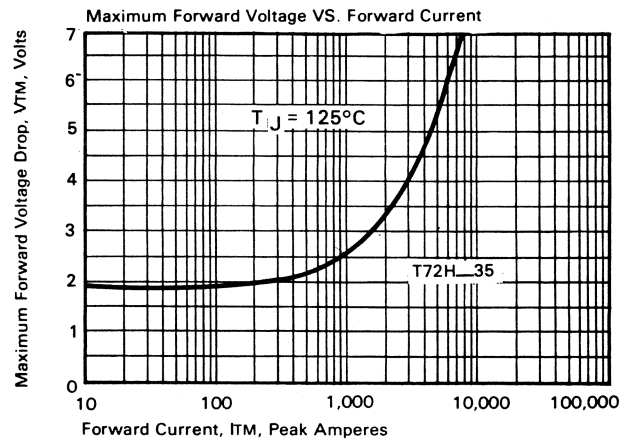

FAST SWITCHING  
THYRISTORS

# Fast Switching SCR T72H\_35

350A Avg.  
(550 RMS)  
Up to 1200 Volts  
10-50  $\mu$ s

## Sinusoidal Current Data

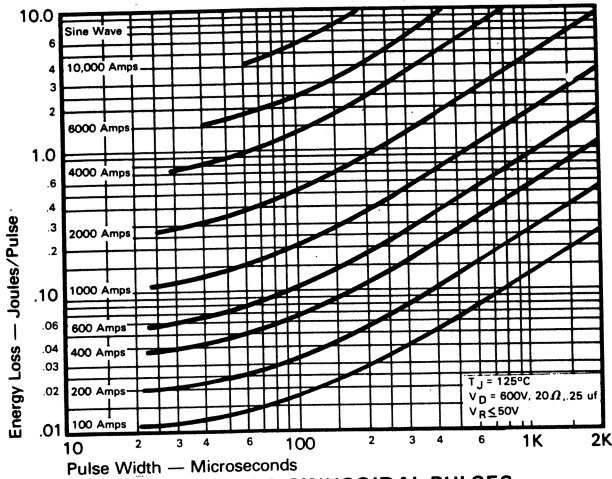

ENERGY PER PULSE FOR SINUSOIDAL PULSES

## Trapezoidal Wave Current Data

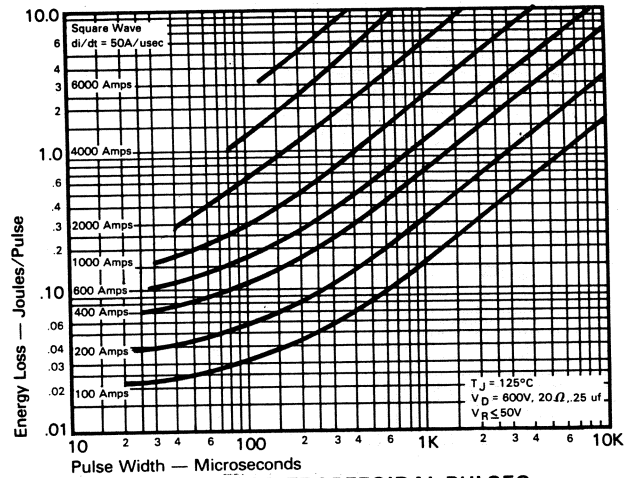

ENERGY PER PULSE FOR TRAPEZOIDAL PULSES  
(di/dt = 50A/usec)

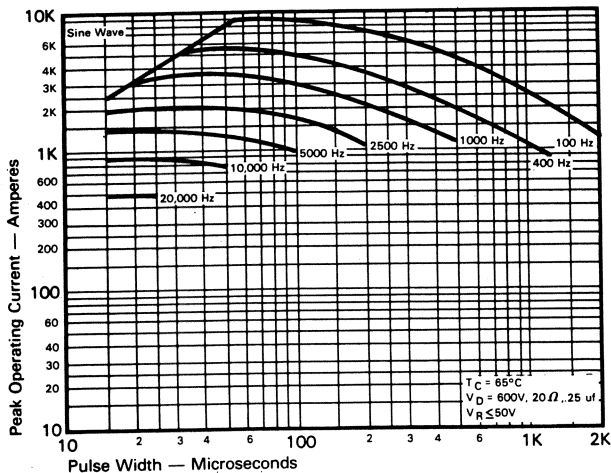

MAXIMUM ALLOWABLE PEAK ON-STATE CURRENT  
vs. PULSE WIDTH ( $T_C = 65^\circ\text{C}$ )

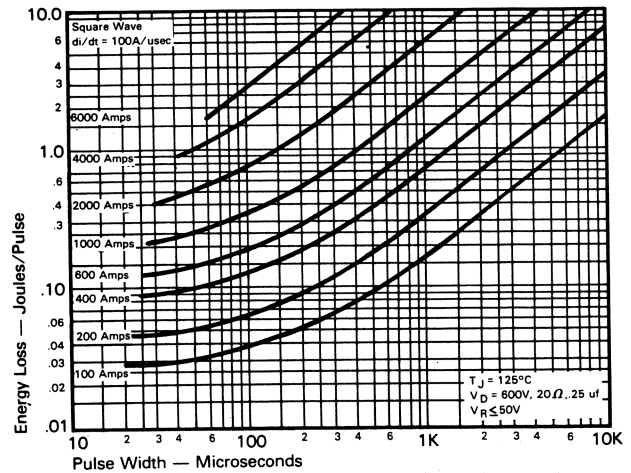

ENERGY PER PULSE FOR TRAPEZOIDAL PULSES  
(di/dt = 100A/usec)

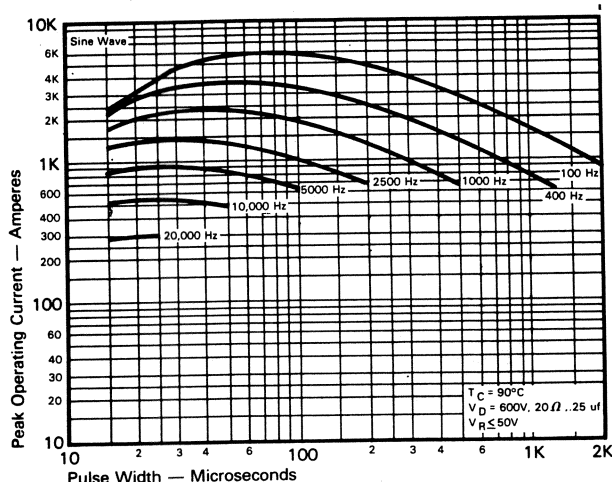

MAXIMUM ALLOWABLE PEAK ON-STATE CURRENT  
vs. PULSE WIDTH ( $T_C = 90^\circ\text{C}$ )

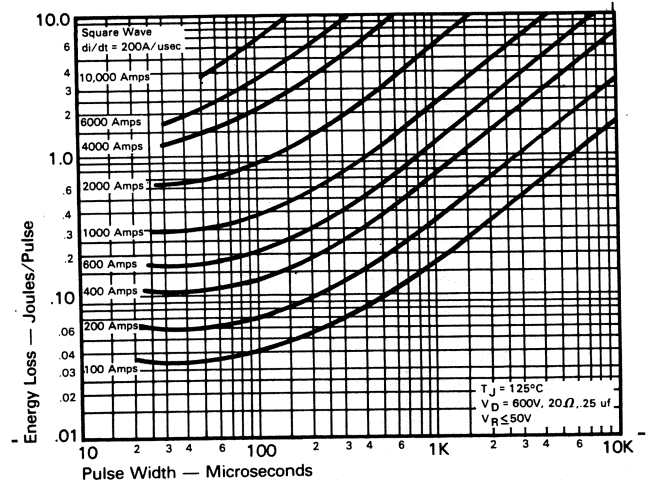

ENERGY PER PULSE FOR TRAPEZOIDAL PULSES  
(di/dt = 200A/usec)

**350A Avg.  
(550 RMS)  
Up to 1200 Volts  
10-50  $\mu$ s**

**Fast Switching  
SCR  
T72H\_35**

**Trapezoidal Wave Current Data  
( $T_C = 65^\circ\text{C}$ )**

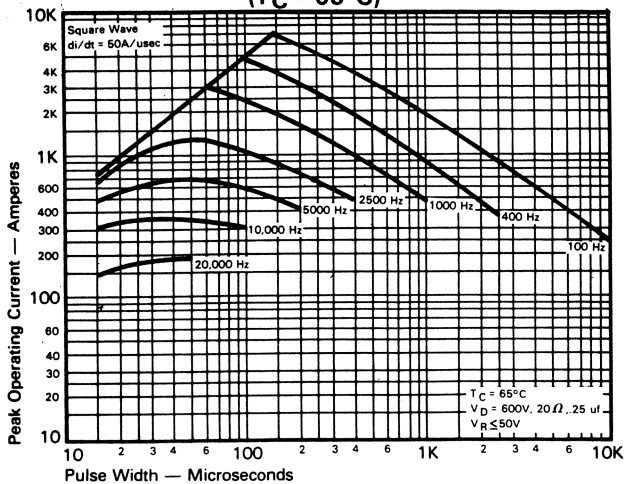

**MAXIMUM ALLOWABLE PEAK ON-STATE CURRENT vs. PULSE WIDTH ( $di/dt = 50A/usec$ )**

**Trapezoidal Wave Current Data  
( $T_C = 90^\circ\text{C}$ )**

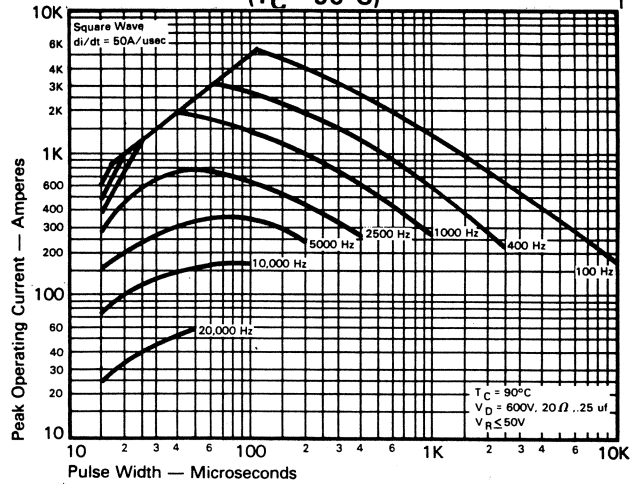

**MAXIMUM ALLOWABLE PEAK ON-STATE CURRENT vs. PULSE WIDTH ( $di/dt = 50A/usec$ )**

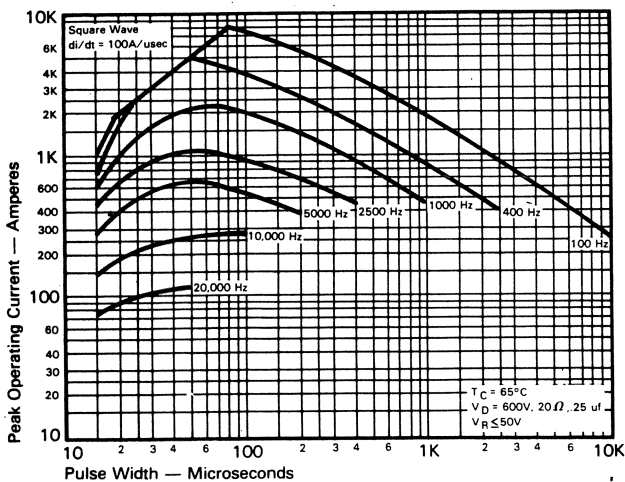

**MAXIMUM ALLOWABLE PEAK ON-STATE CURRENT vs. PULSE WIDTH ( $di/dt = 100A/usec$ )**

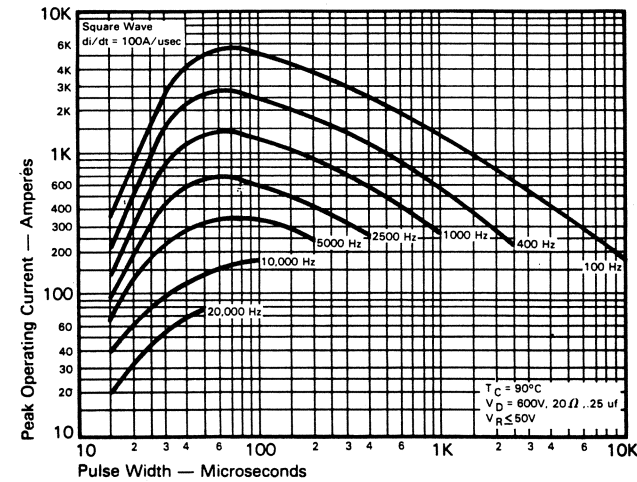

**MAXIMUM ALLOWABLE PEAK ON-STATE CURRENT vs. PULSE WIDTH ( $di/dt = 100A/usec$ )**

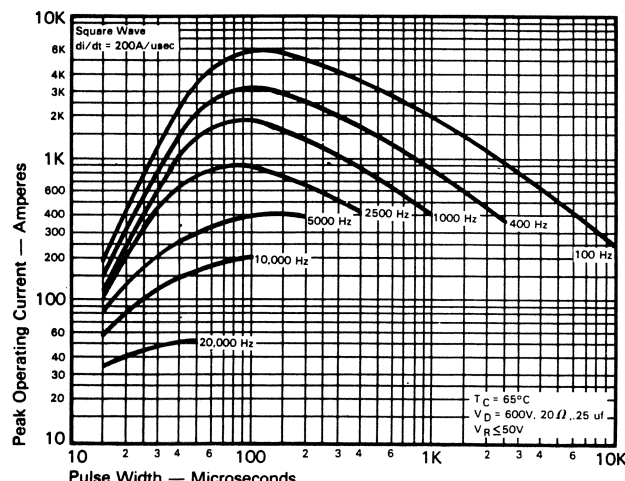

**MAXIMUM ALLOWABLE PEAK ON-STATE CURRENT vs. PULSE WIDTH ( $di/dt = 200A/usec$ )**

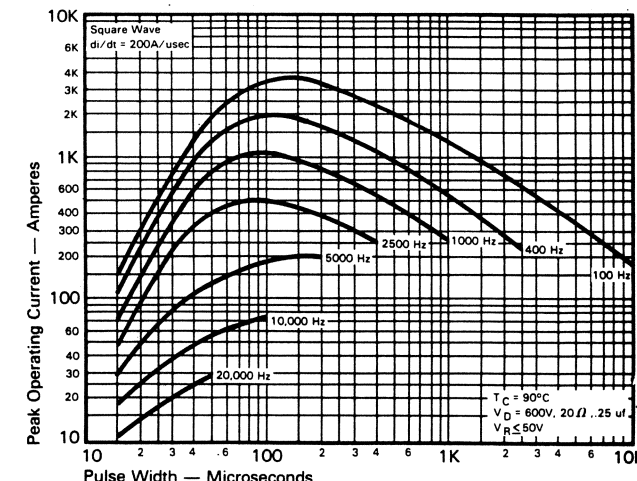

**MAXIMUM ALLOWABLE PEAK ON-STATE CURRENT vs. PULSE WIDTH ( $di/dt = 200A/usec$ )**

FAST SWITCHING THYRISTORS