



Bridgelux® Gen 8 Vero® SE 10 Array

Product Data Sheet DS430



Introduction

Vero SE



The Vero® SE Series is a revolutionary light source system that integrates Bridgelux's eighth generation COB technology with poke-in connectivity, enabling solder-free installation. Vero SE LED light sources streamline assembly processes, lower manufacturing costs, simplify the luminaire design process, improve light quality, and increase design flexibility.

Vero SE is available in four different light emitting surface (LES) configurations that operate reliably over a broad current range. With Vero SE, secondary connector and holder components are not required, allowing for rapid integration of arrays into fixtures, and an efficient field replaceable solution. Vero SE arrays deliver increased lumen density for improved beam control and precision lighting, with 2 and 3 SDCM color control standards for clean and consistent uniform lighting.

Features

- Poke-in electrical connectivity
- Top side part number markings
- Efficacy of 173 lm/W typical, 3000K 80 CRI
- Reliable operation at up to 3x nominal current, 30% increase in maximum lumens per LES size
- Wide selection of CCT options (2700K-6500K) with minimum 70, 80 and 90 CRI options
- Uniform high-quality illumination
- 2 and 3 SDCM binning options (2700K – 4000K)
- Forward voltage bin codes (backside marking)
- 10-Year warranty

Benefits

- Low cost, solderless, connector free installation and field upgradability
- Improved inventory management and quality control
- Enables high efficiency lighting systems and lower operating costs
- Supports the trend toward luminaire miniaturization and delivers enhanced optical control
- Design flexibility for a broad range of lighting applications
- Clean white light without pixelation
- Uniform consistent white light
- Design flexibility for multi-source applications
- Design with confidence



Contents

Product Feature Map	2
Product Nomenclature	2
Product Selection Guide	3
Performance at Commonly Used Drive Currents	7
Electrical Characteristics	17
Eye Safety	18
Absolute Maximum Ratings	19
Performance Curves	20
Typical Radiation Pattern	22
Typical Color Spectrum	23
Mechanical Dimensions	24
Color Binning Information	25
Packaging and Labeling	26
Design Resources	28
Precautions	28
Disclaimers	28
About Bridgelux	29

Product Feature Map

Vero SE 10 is the smallest form factor in the product family of next generation solid state light sources. In addition to delivering the performance and light quality required for many lighting applications,

Vero SE incorporates several features to simplify the design integration and manufacturing process, accelerate time to market and reduce system costs. Please visit www.bridgelux.com for more information on the Vero SE family of products.

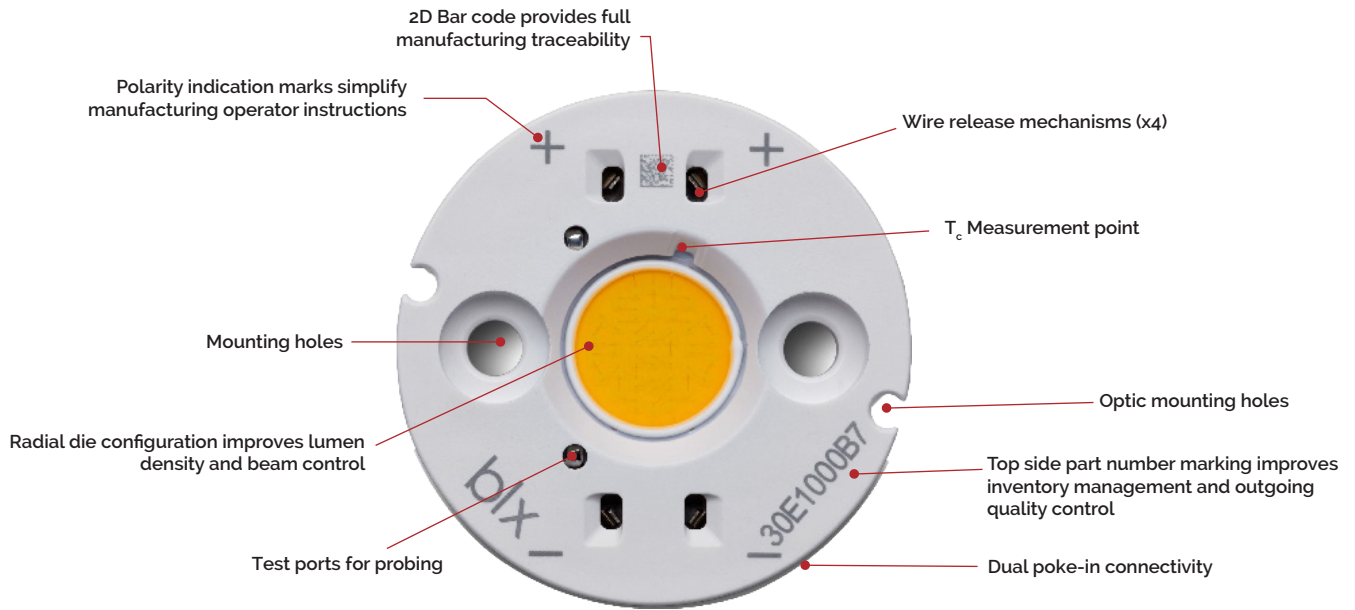

Product Nomenclature

The part number designation for Bridgelux Vero SE LED arrays is explained as follows:

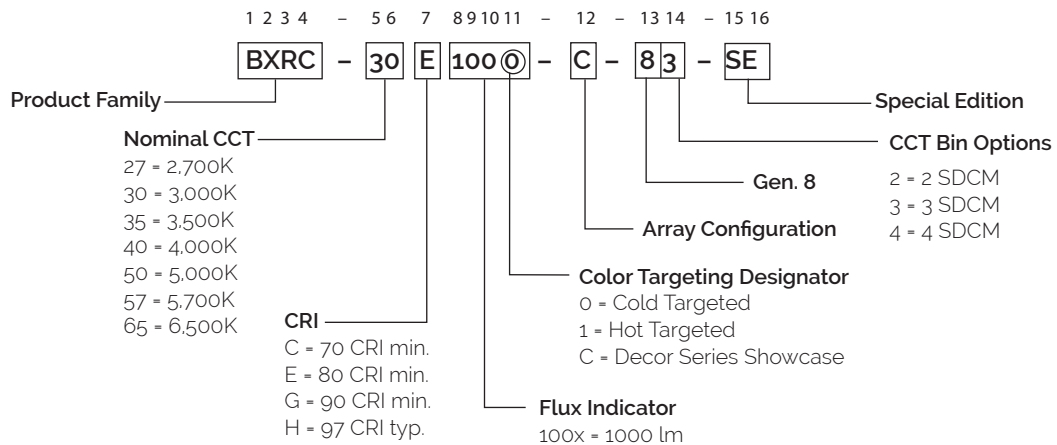

Product Selection Guide

The following product configurations are available:

Table 1: Selection Guide, Pulsed Measurement Data ($T_j = T_c = 25^\circ\text{C}$)

Part Number	Nominal CCT ¹ (K)	CRI ²	Nominal Drive Current ³ (mA)	Typical Pulsed Flux ^{4,5,6} $T_c = 25^\circ\text{C}$ (lm)	Minimum Pulsed Flux ^{6,7} $T_c = 25^\circ\text{C}$ (lm)	Typical V_f (V)	Typical Power (W)	Typical Efficacy (lm/W)
BXRC-27E1000-B-8x-SE	2700	80	200	1113	980	34.2	6.8	163
BXRC-27E1000-C-8x-SE	2700	80	300	1501	1321	30.7	9.2	163
BXRC-27E1000-D-8x-SE	2700	80	250	1014	892	24.9	6.2	163
BXRC-27G1000-B-8x-SE	2700	90	200	919	808	34.2	6.8	134
BXRC-27G1000-C-8x-SE	2700	90	300	1239	1090	30.7	9.2	134
BXRC-27G1000-D-8x-SE	2700	90	250	836	736	24.9	6.2	134
BXRC-27G10H0-B-8x-SE	2700	90	200	958	843	34.2	6.8	140
BXRC-27G10H0-C-8x-SE	2700	90	300	1292	1137	30.7	9.2	140
BXRC-27G10H0-D-8x-SE	2700	90	250	872	768	24.9	6.2	140
BXRC-27H1000-B-8x-SE	2700	97	200	814	716	34.2	6.8	119
BXRC-27H1000-C-8x-SE	2700	97	300	1098	966	30.7	9.2	119
BXRC-27H1000-D-8x-SE	2700	97	250	741	652	24.9	6.2	119
BXRC-30C1001-B-8x-SE	3000	70	200	1239	1090	34.2	6.8	181
BXRC-30C1001-C-8x-SE	3000	70	300	1670	1470	30.7	9.2	181
BXRC-30C1001-D-8x-SE	3000	70	250	1128	992	24.9	6.2	181
BXRC-30E1000-B-8x-SE	3000	80	200	1183	1041	34.2	6.8	173
BXRC-30E1000-C-8x-SE	3000	80	300	1595	1404	30.7	9.2	173
BXRC-30E1000-D-8x-SE	3000	80	250	1077	948	24.9	6.2	173
BXRC-30G1000-B-8x-SE	3000	90	200	960	845	34.2	6.8	140
BXRC-30G1000-C-8x-SE	3000	90	300	1295	1139	30.7	9.2	141
BXRC-30G1000-D-8x-SE	3000	90	250	874	769	24.9	6.2	140
BXRC-30G10H0-B-8x-SE	3000	90	200	1005	885	34.2	6.8	147
BXRC-30G10H0-C-8x-SE	3000	90	300	1356	1193	30.7	9.2	147
BXRC-30G10H0-D-8x-SE	3000	90	250	915	806	24.9	6.2	147
BXRC-30H1000-B-8x-SE	3000	97	200	870	765	34.2	6.8	127
BXRC-30H1000-C-8x-SE	3000	97	300	1173	1032	30.7	9.2	127
BXRC-30H1000-D-8x-SE	3000	97	250	792	697	24.9	6.2	127
BXRC-35E1000-B-8x-SE	3500	80	200	1211	1065	34.2	6.8	177
BXRC-35E1000-C-8x-SE	3500	80	300	1633	1437	30.7	9.2	177
BXRC-35E1000-D-8x-SE	3500	80	250	1102	970	24.9	6.2	177
BXRC-35G1000-B-8x-SE	3500	90	200	995	876	34.2	6.8	145
BXRC-35G1000-C-8x-SE	3500	90	300	1342	1181	30.7	9.2	146
BXRC-35G1000-D-8x-SE	3500	90	250	906	797	24.9	6.2	146
BXRC-40C1001-B-8x-SE	4000	70	200	1273	1121	34.2	6.8	186
BXRC-40C1001-C-8x-SE	4000	70	300	1717	1511	30.7	9.2	186
BXRC-40C1001-D-8x-SE	4000	70	250	1159	1020	24.9	6.2	186

Notes for Table 1:

- Nominal CCT as defined by ANSI C78.377-2011. Products with a CCT of 5000K-6500K are hot targeted to $T_c = 85^\circ\text{C}$.
- CRI values are minimums for all products. Minimum Rg value for 80 CRI products is 0, the minimum Rg value for 90 CRI products is 50, the minimum Rg value for 97 CRI products is 93. Bridgelux maintains a ± 3 tolerance on CRI and Rg values.
- Drive current is referred to as nominal drive current.
- Products tested under pulsed condition (10ms pulse width) at nominal test current where T_j (junction temperature) - T_c (case temperature) = 25°C .
- Typical performance values are provided as a reference only and are not a guarantee of performance.

Product Selection Guide

Table 1: Selection Guide, Pulsed Measurement Data ($T_j = T_c = 25^\circ\text{C}$) (continued)

Part Number	Nominal CCT ¹ (K)	CRI ²	Nominal Drive Current ³ (mA)	Typical Pulsed Flux ^{4,5,6} $T_c = 25^\circ\text{C}$ (lm)	Minimum Pulsed Flux ^{6,7} $T_c = 25^\circ\text{C}$ (lm)	Typical V_f (V)	Typical Power (W)	Typical Efficacy (lm/W)
BXRC-40E1000-B-8x-SE	4000	80	200	1218	1072	34.2	6.8	178
BXRC-40E1000-C-8x-SE	4000	80	300	1642	1445	30.7	9.2	178
BXRC-40E1000-D-8x-SE	4000	80	250	1109	976	24.9	6.2	178
BXRC-40G1000-B-8x-SE	4000	90	200	1016	894	34.2	6.8	149
BXRC-40G1000-C-8x-SE	4000	90	300	1370	1205	30.7	9.2	149
BXRC-40G1000-D-8x-SE	4000	90	250	925	814	24.9	6.2	149
BXRC-50C1001-B-8x-SE	5000	70	200	1280	1127	34.2	6.8	187
BXRC-50C1001-C-8x-SE	5000	70	300	1726	1519	30.7	9.2	187
BXRC-50C1001-D-8x-SE	5000	70	250	1166	1026	24.9	6.2	187
BXRC-50E1001-B-8x-SE	5000	80	200	1232	1084	34.2	6.8	180
BXRC-50E1001-C-8x-SE	5000	80	300	1661	1461	30.7	9.2	180
BXRC-50E1001-D-8x-SE	5000	80	250	1121	987	24.9	6.2	180
BXRC-50G1001-B-8x-SE	5000	90	200	1065	937	34.2	6.8	156
BXRC-50G1001-C-8x-SE	5000	90	300	1436	1263	30.7	9.2	156
BXRC-50G1001-D-8x-SE	5000	90	250	969	853	24.9	6.2	156
BXRC-57C1001-B-8x-SE	5700	70	200	1246	1096	34.2	6.8	182
BXRC-57C1001-C-8x-SE	5700	70	300	1679	1478	30.7	9.2	182
BXRC-57C1001-D-8x-SE	5700	70	250	1134	998	24.9	6.2	182
BXRC-57E1001-B-8x-SE	5700	80	200	1183	1041	34.2	6.8	173
BXRC-57E1001-C-8x-SE	5700	80	300	1595	1404	30.7	9.2	173
BXRC-57E1001-D-8x-SE	5700	80	250	1077	948	24.9	6.2	173
BXRC-65C1001-B-8x-SE	6500	70	200	1246	1096	34.2	6.8	182
BXRC-65C1001-C-8x-SE	6500	70	300	1679	1478	30.7	9.2	182
BXRC-65C1001-D-8x-SE	6500	70	250	1134	998	24.9	6.2	182
BXRC-65E1001-B-8x-SE	6500	80	200	1197	1053	34.2	6.8	175
BXRC-65E1001-C-8x-SE	6500	80	300	1614	1420	30.7	9.2	175
BXRC-65E1001-D-8x-SE	6500	80	250	1090	959	24.9	6.2	175

Notes for Table 1:

- Nominal CCT as defined by ANSI C78.377-2011. Products with a CCT of 5000K-6500K are hot targeted to $T_c = 85^\circ\text{C}$.
- CRI values are minimums for all products. Minimum Rg value for 80 CRI products is 0, the minimum Rg value for 90 CRI products is 50, the minimum Rg value for 97 CRI products is 93. Bridgelux maintains a ± 3 tolerance on CRI and Rg values.
- Drive current is referred to as nominal drive current.
- Products tested under pulsed condition (10ms pulse width) at nominal test current where T_j (junction temperature) = T_c (case temperature) = 25°C .
- Typical performance values are provided as a reference only and are not a guarantee of performance.
- Bridgelux maintains a $\pm 7\%$ tolerance on flux measurements.
- Minimum flux values at the nominal test current are guaranteed by 100% test.

Product Selection Guide

Table 2: Selection Guide, Stabilized DC Performance ($T_c = 85^\circ\text{C}$)^{4,5}

Part Number	Nominal CCT ¹ (K)	CRI ²	Nominal Drive Current ³ (mA)	Typical DC Flux ^{4,5} $T_c = 85^\circ\text{C}$ (lm)	Minimum DC Flux ⁶ $T_c = 85^\circ\text{C}$ (lm)	Typical V_f (V)	Typical Power (W)	Typical Efficacy (lm/W)
BXRC-27E1000-B-8x-SE	2700	80	200	1002	882	33.6	6.7	149
BXRC-27E1000-C-8x-SE	2700	80	300	1351	1189	30.1	9.0	150
BXRC-27E1000-D-8x-SE	2700	80	250	912	803	24.4	6.1	149
BXRC-27G1000-B-8x-SE	2700	90	200	827	727	33.6	6.7	123
BXRC-27G1000-C-8x-SE	2700	90	300	1115	981	30.1	9.0	123
BXRC-27G1000-D-8x-SE	2700	90	250	753	662	24.4	6.1	123
BXRC-27G10H0-B-8x-SE	2700	90	200	862	759	33.6	6.7	129
BXRC-27G10H0-C-8x-SE	2700	90	300	1163	1023	30.1	9.0	129
BXRC-27G10H0-D-8x-SE	2700	90	250	785	691	24.4	6.1	129
BXRC-27H1000-B-8x-SE	2700	97	200	733	645	33.6	6.7	109
BXRC-27H1000-C-8x-SE	2700	97	300	988	869	30.1	9.0	109
BXRC-27H1000-D-8x-SE	2700	97	250	667	587	24.4	6.1	109
BXRC-30C1001-B-8x-SE	3000	70	200	1115	981	33.6	6.7	166
BXRC-30C1001-C-8x-SE	3000	70	300	1503	1323	30.1	9.0	166
BXRC-30C1001-D-8x-SE	3000	70	250	1015	893	24.4	6.1	166
BXRC-30E1000-B-8x-SE	3000	80	200	1065	937	33.6	6.7	159
BXRC-30E1000-C-8x-SE	3000	80	300	1436	1263	30.1	9.0	159
BXRC-30E1000-D-8x-SE	3000	80	250	969	853	24.4	6.1	159
BXRC-30G1000-B-8x-SE	3000	90	200	864	761	33.6	6.7	129
BXRC-30G1000-C-8x-SE	3000	90	300	1165	1025	30.1	9.0	129
BXRC-30G1000-D-8x-SE	3000	90	250	787	692	24.4	6.1	129
BXRC-30G10H0-B-8x-SE	3000	90	200	905	796	33.6	6.7	135
BXRC-30G10H0-C-8x-SE	3000	90	300	1220	1074	30.1	9.0	135
BXRC-30G10H0-D-8x-SE	3000	90	250	824	725	24.4	6.1	135
BXRC-30H1000-B-8x-SE	3000	97	200	783	689	33.6	6.7	117
BXRC-30H1000-C-8x-SE	3000	97	300	1056	929	30.1	9.0	117
BXRC-30H1000-D-8x-SE	3000	97	250	713	627	24.4	6.1	117
BXRC-35E1000-B-8x-SE	3500	80	200	1090	959	33.6	6.7	162
BXRC-35E1000-C-8x-SE	3500	80	300	1469	1293	30.1	9.0	163
BXRC-35E1000-D-8x-SE	3500	80	250	992	873	24.4	6.1	162
BXRC-35G1000-B-8x-SE	3500	90	200	896	788	33.6	6.7	133
BXRC-35G1000-C-8x-SE	3500	90	300	1208	1063	30.1	9.0	134
BXRC-35G1000-D-8x-SE	3500	90	250	815	717	24.4	6.1	134
BXRC-40C1001-B-8x-SE	4000	70	200	1146	1009	33.6	6.7	171
BXRC-40C1001-C-8x-SE	4000	70	300	1545	1360	30.1	9.0	171
BXRC-40C1001-D-8x-SE	4000	70	250	1043	918	24.4	6.1	171

Notes for Table 2:

- Nominal CCT as defined by ANSI C78 377-2011. Products with a CCT of 5000K-6500K are hot targeted to $T_c = 85^\circ\text{C}$.
- CRI values are minimums for all products. Minimum Rg value for 80 CRI products is 0, the minimum Rg value for 90 CRI products is 50, the minimum Rg value for 97 CRI products is 93. Bridgelux maintains a ± 3 tolerance on CRI and Rg values.
- Drive current is referred to as nominal drive current.
- Typical stabilized DC performance values are provided as reference only and are not a guarantee of performance.
- Typical performance is estimated based on operation under DC (direct current) with LED array mounted onto a heat sink with thermal interface material and the case temperature maintained at 85°C . Based on Bridgelux test setup, values may vary depending on the thermal design of the luminaire and/or the exposed environment to which the product is subjected.
- Minimum flux values at elevated temperatures are provided for reference only and are not guaranteed by 100% production testing. Based on Bridgelux test setup, values may vary depending on the thermal design of the luminaire and/or the exposed environment to which the product is subjected.

Product Selection Guide

Table 2: Selection Guide, Stabilized DC Performance ($T_c = 85^\circ\text{C}$)^{4,5} (continued)

Part Number	Nominal CCT ¹ (K)	CRI ²	Nominal Drive Current ³ (mA)	Typical DC Flux ^{4,5} $T_c = 85^\circ\text{C}$ (lm)	Minimum DC Flux ⁶ $T_c = 85^\circ\text{C}$ (lm)	Typical V_f (V)	Typical Power (W)	Typical Efficacy (lm/W)
BXRC-40E1000-B-8x-SE	4000	80	200	1096	964	33.6	6.7	163
BXRC-40E1000-C-8x-SE	4000	80	300	1478	1300	30.1	9.0	164
BXRC-40E1000-D-8x-SE	4000	80	250	998	878	24.4	6.1	163
BXRC-40G1000-B-8x-SE	4000	90	200	914	805	33.6	6.7	136
BXRC-40G1000-C-8x-SE	4000	90	300	1233	1085	30.1	9.0	136
BXRC-40G1000-D-8x-SE	4000	90	250	832	733	24.4	6.1	136
BXRC-50C1001-B-8x-SE	5000	70	200	1152	1014	33.6	6.7	172
BXRC-50C1001-C-8x-SE	5000	70	300	1554	1367	30.1	9.0	172
BXRC-50C1001-D-8x-SE	5000	70	250	1049	923	24.4	6.1	172
BXRC-50E1001-B-8x-SE	5000	80	200	1108	975	33.6	6.7	165
BXRC-50E1001-C-8x-SE	5000	80	300	1495	1315	30.1	9.0	165
BXRC-50E1001-D-8x-SE	5000	80	250	1009	888	24.4	6.1	165
BXRC-50G1001-B-8x-SE	5000	90	200	958	843	33.6	6.7	143
BXRC-50G1001-C-8x-SE	5000	90	300	1292	1137	30.1	9.0	143
BXRC-50G1001-D-8x-SE	5000	90	250	872	768	24.4	6.1	143
BXRC-57C1001-B-8x-SE	5700	70	200	1121	986	33.6	6.7	167
BXRC-57C1001-C-8x-SE	5700	70	300	1512	1330	30.1	9.0	167
BXRC-57C1001-D-8x-SE	5700	70	250	1021	898	24.4	6.1	167
BXRC-57E1001-B-8x-SE	5700	80	200	1065	937	33.6	6.7	159
BXRC-57E1001-C-8x-SE	5700	80	300	1436	1263	30.1	9.0	159
BXRC-57E1001-D-8x-SE	5700	80	250	969	853	24.4	6.1	159
BXRC-65C1001-B-8x-SE	6500	70	200	1121	986	33.6	6.7	167
BXRC-65C1001-C-8x-SE	6500	70	300	1512	1330	30.1	9.0	167
BXRC-65C1001-D-8x-SE	6500	70	250	1021	898	24.4	6.1	167
BXRC-65E1001-B-8x-SE	6500	80	200	1077	948	33.6	6.7	161
BXRC-65E1001-C-8x-SE	6500	80	300	1452	1278	30.1	9.0	161
BXRC-65E1001-D-8x-SE	6500	80	250	981	863	24.4	6.1	161

Notes for Table 2:

- Nominal CCT as defined by ANSI C78.377-2011. Products with a CCT of 5000K-6500K are hot targeted to $T_c = 85^\circ\text{C}$.
- CRI values are minimums for all products. Minimum Rg value for 80 CRI products is 0, the minimum Rg value for 90 CRI products is 50, the minimum Rg value for 97 CRI products is 93. Bridgelux maintains a ± 3 tolerance on CRI and Rg values.
- Drive current is referred to as nominal drive current.
- Typical stabilized DC performance values are provided as reference only and are not a guarantee of performance.
- Typical performance is estimated based on operation under DC (direct current) with LED array mounted onto a heat sink with thermal interface material and the case temperature maintained at 85°C . Based on Bridgelux test setup, values may vary depending on the thermal design of the luminaire and/or the exposed environment to which the product is subjected.
- Minimum flux values at elevated temperatures are provided for reference only and are not guaranteed by 100% production testing. Based on Bridgelux test setup, values may vary depending on the thermal design of the luminaire and/or the exposed environment to which the product is subjected.

Performance at Commonly Used Drive Currents

Vero LED arrays are tested to the specifications shown using the nominal drive currents in Table 1. Vero SE may also be driven at other drive currents dependent on specific application design requirements. The performance at any drive current can be derived from the current vs. voltage characteristics shown in Figures 1, 2 & 3 and the flux vs. current characteristics shown in Figures 4, 5 & 6. The performance at commonly used drive currents is summarized in Table 3.

Table 3: Product Performance at Commonly Used Drive Currents

Part Number	CRI	Drive Current ¹ (mA)	Typical V _f T _c = 25°C (V)	Typical Power T _c = 25°C (W)	Typical Flux ² T _c = 25°C (lm)	Typical DC Flux ³ T _c = 85°C (lm)	Typical Efficacy T _c = 25°C (lm/W)
BXRC-27E1000-B-8x-SE	80	100	32.9	3.3	580	522	176
		150	33.6	5.0	848	763	168
		200	34.2	6.8	1113	1002	163
		270	35.0	9.5	1458	1312	154
		400	36.5	14.6	2071	1864	142
		500	37.5	18.7	2509	2258	134
BXRC-27E1000-C-8x-SE	80	150	29.6	4.4	783	704	176
		225	30.2	6.8	1143	1028	168
		300	30.7	9.2	1501	1351	163
		360	31.2	11.2	1766	1589	157
		600	32.8	19.7	2793	2514	142
		1000	35.0	35.0	4277	3849	122
BXRC-27E1000-D-8x-SE	80	125	24.0	3.0	528	476	176
		185	24.4	4.5	762	686	169
		250	24.9	6.2	1014	912	163
		350	25.6	9.0	1372	1235	153
		500	26.6	13.3	1886	1697	142
		1000	29.1	29.1	3316	2984	114
BXRC-27G1000-B-8x-SE	90	100	32.9	3.3	479	431	146
		150	33.6	5.0	699	629	139
		200	34.2	6.8	919	827	134
		270	35.0	9.5	1203	1083	127
		400	36.5	14.6	1709	1538	117
		500	37.5	18.7	2070	1863	110
BXRC-27G1000-C-8x-SE	90	150	29.6	4.4	646	581	146
		225	30.2	6.8	943	849	139
		300	30.7	9.2	1239	1115	134
		360	31.2	11.2	1457	1311	130
		600	32.8	19.7	2304	2074	117
		1000	35.0	35.0	3528	3175	101
BXRC-27G1000-D-8x-SE	90	125	24.0	3.0	436	392	146
		185	24.4	4.5	629	566	139
		250	24.9	6.2	836	753	134
		350	25.6	9.0	1132	1019	126
		500	26.6	13.3	1556	1400	117
		1000	29.1	29.1	2736	2462	94

Notes for Table 3:

1. Alternate drive currents in Table 3 are provided for reference only and are not a guarantee of performance.
2. Bridgelux maintains a ± 7% tolerance on flux measurements.
3. Typical stabilized DC performance values are provided as reference only and are not a guarantee of performance.

Performance at Commonly Used Drive Currents

Table 3: Product Performance at Commonly Used Drive Currents (Continued)

Part Number	CRI	Drive Current ¹ (mA)	Typical V _f T _c = 25°C (V)	Typical Power T _c = 25°C (W)	Typical Flux ² T _c = 25°C (lm)	Typical DC Flux ³ T _c = 85°C (lm)	Typical Efficacy T _c = 25°C (lm/W)
BXRC-27G10H0-B-8x-SE	90	100	32.9	3.3	499	450	152
		150	33.6	5.0	729	656	145
		200	34.2	6.8	958	862	140
		270	35.0	9.5	1255	1130	133
		400	36.5	14.6	1783	1604	122
		500	37.5	18.7	2159	1943	115
BXRC-27G10H0-C-8x-SE	90	150	29.6	4.4	673	606	152
		225	30.2	6.8	984	885	145
		300	30.7	9.2	1292	1163	140
		360	31.2	11.2	1520	1368	135
		600	32.8	19.7	2404	2163	122
		1000	35.0	35.0	3681	3313	105
BXRC-27G10H0-D-8x-SE	90	125	24.0	3.0	455	409	152
		185	24.4	4.5	656	590	145
		250	24.9	6.2	872	785	140
		350	25.6	9.0	1181	1063	132
		500	26.6	13.3	1623	1461	122
		1000	29.1	29.1	2854	2568	98
BXRC-27H1000-B-8x-SE	97	100	32.9	3.3	424	382	129
		150	33.6	5.0	620	558	123
		200	34.2	6.8	814	733	119
		270	35.0	9.5	1066	960	113
		400	36.5	14.6	1515	1363	104
		500	37.5	18.7	1835	1651	98
BXRC-27H1000-C-8x-SE	97	150	29.8	4.5	575	518	129
		225	30.3	6.8	839	755	123
		300	30.7	9.2	1098	988	119
		360	31.1	11.2	1301	1171	116
		600	32.4	19.4	2078	1870	107
		1000	34.3	34.3	3250	2925	95
BXRC-27H1000-D-8x-SE	97	125	24.3	3.0	389	350	128
		185	24.6	4.5	560	504	123
		250	24.9	6.2	741	667	119
		350	25.4	8.9	1014	913	114
		500	26.1	13.0	1410	1269	108
		1000	28.1	28.1	2601	2341	93
BXRC-30C1001-B-8x-SE	70	100	32.9	3.3	646	581	196
		150	33.6	5.0	943	849	187
		200	34.2	6.8	1239	1115	181
		270	35.0	9.5	1622	1460	172
		400	36.5	14.6	2305	2074	158
		500	37.5	18.7	2791	2512	149

Notes for Table 3:

1. Alternate drive currents in Table 3 are provided for reference only and are not a guarantee of performance.
2. Bridgelux maintains a ± 7% tolerance on flux measurements.
3. Typical stabilized DC performance values are provided as reference only and are not a guarantee of performance.

Performance at Commonly Used Drive Currents

Table 3: Product Performance at Commonly Used Drive Currents (Continued)

Part Number	CRI	Drive Current ¹ (mA)	Typical V_f $T_c = 25^\circ\text{C}$ (V)	Typical Power $T_c = 25^\circ\text{C}$ (W)	Typical Flux ² $T_c = 25^\circ\text{C}$ (lm)	Typical DC Flux ³ $T_c = 85^\circ\text{C}$ (lm)	Typical Efficacy $T_c = 25^\circ\text{C}$ (lm/W)
BXRC-30C1001-C-8x-SE	70	150	29.8	4.5	875	787	196
		225	30.3	6.8	1277	1149	187
		300	30.7	9.2	1670	1503	181
		360	31.1	11.2	1979	1781	177
		600	32.4	19.4	3161	2845	163
		1000	34.3	34.3	4944	4450	144
BXRC-30C1001-D-8x-SE	70	125	24.3	3.0	592	533	195
		185	24.6	4.5	851	766	187
		250	24.9	6.2	1128	1015	181
		350	25.4	8.9	1543	1389	174
		500	26.1	13.0	2144	1930	165
		1000	28.1	28.1	3958	3562	141
BXRC-30E1000-B-8x-SE	80	100	32.9	3.3	617	555	187
		150	33.6	5.0	900	810	179
		200	34.2	6.8	1183	1065	173
		270	35.0	9.5	1549	1394	164
		400	36.5	14.6	2201	1981	151
		500	37.5	18.7	2666	2399	142
BXRC-30E1000-C-8x-SE	80	150	29.8	4.5	836	752	187
		225	30.3	6.8	1219	1097	179
		300	30.7	9.2	1595	1436	173
		360	31.1	11.2	1890	1701	169
		600	32.4	19.4	3019	2717	155
		1000	34.3	34.3	4722	4250	137
BXRC-30E1000-D-8x-SE	80	125	24.3	3.0	565	509	186
		185	24.6	4.5	813	732	179
		250	24.9	6.2	1077	969	173
		350	25.4	8.9	1474	1326	166
		500	26.1	13.0	2048	1843	157
		1000	28.1	28.1	3780	3402	135
BXRC-30G1000-B-8x-SE	90	100	32.9	3.3	501	451	152
		150	33.6	5.0	731	658	145
		200	34.2	6.8	960	864	140
		270	35.0	9.5	1258	1132	133
		400	36.5	14.6	1787	1608	122
		500	37.5	18.7	2164	1948	115
BXRC-30G1000-C-8x-SE	90	150	29.8	4.5	678	610	152
		225	30.3	6.8	990	891	145
		300	30.7	9.2	1295	1165	140
		360	31.1	11.2	1534	1381	137
		600	32.4	19.4	2451	2206	126
		1000	34.3	34.3	3833	3450	112

Notes for Table 3:

1. Alternate drive currents in Table 3 are provided for reference only and are not a guarantee of performance.
2. Bridgelux maintains a $\pm 7\%$ tolerance on flux measurements.
3. Typical stabilized DC performance values are provided as reference only and are not a guarantee of performance.

Performance at Commonly Used Drive Currents

Table 3: Product Performance at Commonly Used Drive Currents (Continued)

Part Number	CRI	Drive Current ¹ (mA)	Typical V _f T _c = 25°C (V)	Typical Power T _c = 25°C (W)	Typical Flux ² T _c = 25°C (lm)	Typical DC Flux ³ T _c = 85°C (lm)	Typical Efficacy T _c = 25°C (lm/W)
BXRC-30G1000-D-8x-SE	90	125	24.3	3.0	459	413	151
		185	24.6	4.5	660	594	145
		250	24.9	6.2	874	787	140
		350	25.4	8.9	1196	1077	135
		500	26.1	13.0	1663	1496	128
		1000	28.1	28.1	3068	2761	109
BXRC-30G10H0-B-8x-SE	90	100	32.9	3.3	524	472	159
		150	33.6	5.0	765	689	152
		200	34.2	6.8	1005	905	147
		270	35.0	9.5	1317	1185	139
		400	36.5	14.6	1871	1684	128
		500	37.5	18.7	2266	2039	121
BXRC-30G10H0-C-8x-SE	90	150	29.8	4.5	710	639	159
		225	30.3	6.8	1036	933	152
		300	30.7	9.2	1356	1220	147
		360	31.1	11.2	1606	1446	144
		600	32.4	19.4	2566	2310	132
		1000	34.3	34.3	4014	3612	117
BXRC-30G10H0-D-8x-SE	90	125	24.3	3.0	480	432	158
		185	24.6	4.5	691	622	152
		250	24.9	6.2	915	824	147
		350	25.4	8.9	1253	1127	141
		500	26.1	13.0	1741	1567	134
		1000	28.1	28.1	3213	2892	114
BXRC-30H1000-B-8x-SE	97	100	32.9	3.3	453	408	138
		150	33.6	5.0	662	596	132
		200	34.2	6.8	870	783	127
		270	35.0	9.5	1139	1025	120
		400	36.5	14.6	1618	1457	111
		500	37.5	18.7	1960	1764	105
BXRC-30H1000-C-8x-SE	97	150	29.8	4.5	614	553	137
		225	30.3	6.8	897	807	132
		300	30.7	9.2	1173	1056	127
		360	31.1	11.2	1390	1251	124
		600	32.4	19.4	2220	1998	114
		1000	34.3	34.3	3472	3125	101
BXRC-30H1000-D-8x-SE	97	125	24.3	3.0	416	374	137
		185	24.6	4.5	598	538	131
		250	24.9	6.2	792	713	127
		350	25.4	8.9	1084	975	122
		500	26.1	13.0	1506	1355	116
		1000	28.1	28.1	2779	2501	99

Notes for Table 3:

1. Alternate drive currents in Table 3 are provided for reference only and are not a guarantee of performance.
2. Bridgelux maintains a ± 7% tolerance on flux measurements.
3. Typical stabilized DC performance values are provided as reference only and are not a guarantee of performance.

Performance at Commonly Used Drive Currents

Table 3: Product Performance at Commonly Used Drive Currents (Continued)

Part Number	CRI	Drive Current ¹ (mA)	Typical V_f $T_c = 25^\circ\text{C}$ (V)	Typical Power $T_c = 25^\circ\text{C}$ (W)	Typical Flux ² $T_c = 25^\circ\text{C}$ (lm)	Typical DC Flux ³ $T_c = 85^\circ\text{C}$ (lm)	Typical Efficacy $T_c = 25^\circ\text{C}$ (lm/W)
BXRC-35E1000-B-8x-SE	80	100	32.9	3.3	631	568	192
		150	33.6	5.0	922	829	183
		200	34.2	6.8	1211	1090	177
		270	35.0	9.5	1586	1427	168
		400	36.5	14.6	2253	2027	154
		500	37.5	18.7	2728	2456	146
BXRC-35E1000-C-8x-SE	80	150	29.8	4.5	855	770	191
		225	30.3	6.8	1248	1123	183
		300	30.7	9.2	1633	1469	177
		360	31.1	11.2	1934	1741	173
		600	32.4	19.4	3090	2781	159
		1000	34.3	34.3	4833	4350	141
BXRC-35E1000-D-8x-SE	80	125	24.3	3.0	578	521	191
		185	24.6	4.5	832	749	183
		250	24.9	6.2	1102	992	177
		350	25.4	8.9	1509	1358	170
		500	26.1	13.0	2096	1887	161
		1000	28.1	28.1	3869	3482	138
BXRC-35G1000-B-8x-SE	90	100	32.9	3.3	519	467	158
		150	33.6	5.0	757	682	150
		200	34.2	6.8	995	896	146
		270	35.0	9.5	1303	1173	138
		400	36.5	14.6	1851	1666	127
		500	37.5	18.7	2242	2018	120
BXRC-35G1000-C-8x-SE	90	150	29.8	4.5	703	633	157
		225	30.3	6.8	1026	923	151
		300	30.7	9.2	1342	1208	146
		360	31.1	11.2	1590	1431	142
		600	32.4	19.4	2540	2286	131
		1000	34.3	34.3	3972	3575	116
BXRC-35G1000-D-8x-SE	90	125	24.3	3.0	475	428	157
		185	24.6	4.5	684	615	150
		250	24.9	6.2	906	815	146
		350	25.4	8.9	1240	1116	140
		500	26.1	13.0	1723	1551	132
		1000	28.1	28.1	3179	2861	113
BXRC-40C1001-B-8x-SE	70	100	32.9	3.3	664	597	202
		150	33.6	5.0	969	872	193
		200	34.2	6.8	1273	1146	186
		270	35.0	9.5	1668	1501	176
		400	36.5	14.6	2369	2132	162
		500	37.5	18.7	2870	2583	153

Notes for Table 3:

1. Alternate drive currents in Table 3 are provided for reference only and are not a guarantee of performance.
2. Bridgelux maintains a $\pm 7\%$ tolerance on flux measurements.
3. Typical stabilized DC performance values are provided as reference only and are not a guarantee of performance.

Performance at Commonly Used Drive Currents

Table 3: Product Performance at Commonly Used Drive Currents (Continued)

Part Number	CRI	Drive Current ¹ (mA)	Typical V _f T _c = 25°C (V)	Typical Power T _c = 25°C (W)	Typical Flux ² T _c = 25°C (lm)	Typical DC Flux ³ T _c = 85°C (lm)	Typical Efficacy T _c = 25°C (lm/W)
BXRC-40C1001-C-8x-SE	70	150	29.8	4.5	899	810	201
		225	30.3	6.8	1313	1181	193
		300	30.7	9.2	1717	1545	186
		360	31.1	11.2	2035	1831	182
		600	32.4	19.4	3250	2925	167
		1000	34.3	34.3	5083	4575	148
BXRC-40C1001-D-8x-SE	70	125	24.3	3.0	608	547	200
		185	24.6	4.5	875	788	192
		250	24.9	6.2	1159	1043	186
		350	25.4	8.9	1587	1428	179
		500	26.1	13.0	2205	1984	169
		1000	28.1	28.1	4069	3662	145
BXRC-40E1000-B-8x-SE	80	100	32.9	3.3	635	571	193
		150	33.6	5.0	927	834	184
		200	34.2	6.8	1218	1096	178
		270	35.0	9.5	1595	1435	169
		400	36.5	14.6	2266	2039	155
		500	37.5	18.7	2744	2470	146
BXRC-40E1000-C-8x-SE	80	150	29.8	4.5	860	774	192
		225	30.3	6.8	1255	1130	184
		300	30.7	9.2	1642	1478	178
		360	31.1	11.2	1946	1751	174
		600	32.4	19.4	3108	2797	160
		1000	34.3	34.3	4861	4375	142
BXRC-40E1000-D-8x-SE	80	125	24.3	3.0	582	524	192
		185	24.6	4.5	837	753	184
		250	24.9	6.2	1109	998	178
		350	25.4	8.9	1517	1365	171
		500	26.1	13.0	2108	1897	162
		1000	28.1	28.1	3891	3502	138
BXRC-40G1000-B-8x-SE	90	100	32.9	3.3	530	477	161
		150	33.6	5.0	773	696	154
		200	34.2	6.8	1016	914	149
		270	35.0	9.5	1331	1198	141
		400	36.5	14.6	1890	1701	130
		500	37.5	18.7	2289	2060	122
BXRC-40G1000-C-8x-SE	90	150	29.8	4.5	718	646	160
		225	30.3	6.8	1047	942	154
		300	30.7	9.2	1370	1233	149
		360	31.1	11.2	1623	1461	145
		600	32.4	19.4	2593	2334	133
		1000	34.3	34.3	4055	3650	118

Notes for Table 3:

1. Alternate drive currents in Table 3 are provided for reference only and are not a guarantee of performance.
2. Bridgelux maintains a ± 7% tolerance on flux measurements.
3. Typical stabilized DC performance values are provided as reference only and are not a guarantee of performance.

Performance at Commonly Used Drive Currents

Table 3: Product Performance at Commonly Used Drive Currents (Continued)

Part Number	CRI	Drive Current ¹ (mA)	Typical V _f T _c = 25°C (V)	Typical Power T _c = 25°C (W)	Typical Flux ² T _c = 25°C (lm)	Typical DC Flux ³ T _c = 85°C (lm)	Typical Efficacy T _c = 25°C (lm/W)
BXRC-40G1000-D-8x-SE	90	125	24.3	3.0	485	437	160
		185	24.6	4.5	698	628	154
		250	24.9	6.2	925	832	149
		350	25.4	8.9	1266	1139	142
		500	26.1	13.0	1759	1583	135
		1000	28.1	28.1	3246	2922	116
BXRC-50C1001-B-8x-SE	70	100	32.9	3.3	667	601	203
		150	33.6	5.0	975	877	194
		200	34.2	6.8	1280	1152	187
		270	35.0	9.5	1677	1509	177
		400	36.5	14.6	2382	2144	163
		500	37.5	18.7	2885	2597	154
BXRC-50C1001-C-8x-SE	70	150	29.8	4.5	904	814	202
		225	30.3	6.8	1320	1188	194
		300	30.7	9.2	1726	1554	187
		360	31.1	11.2	2046	1841	183
		600	32.4	19.4	3268	2941	168
		1000	34.3	34.3	5111	4600	149
BXRC-50C1001-D-8x-SE	70	125	24.3	3.0	612	550	202
		185	24.6	4.5	880	792	194
		250	24.9	6.2	1166	1049	187
		350	25.4	8.9	1595	1436	180
		500	26.1	13.0	2217	1995	170
		1000	28.1	28.1	4091	3682	146
BXRC-50E1001-B-8x-SE	80	100	32.9	3.3	642	578	195
		150	33.6	5.0	938	844	186
		200	34.2	6.8	1232	1108	180
		270	35.0	9.5	1613	1452	171
		400	36.5	14.6	2292	2062	157
		500	37.5	18.7	2775	2498	148
BXRC-50E1001-C-8x-SE	80	150	29.8	4.5	870	783	194
		225	30.3	6.8	1269	1143	186
		300	30.7	9.2	1661	1495	180
		360	31.1	11.2	1968	1771	176
		600	32.4	19.4	3144	2829	162
		1000	34.3	34.3	4916	4425	143
BXRC-50E1001-D-8x-SE	80	125	24.3	3.0	588	530	194
		185	24.6	4.5	846	762	186
		250	24.9	6.2	1121	1009	180
		350	25.4	8.9	1535	1381	173
		500	26.1	13.0	2132	1919	164
		1000	28.1	28.1	3935	3542	140

Notes for Table 3:

1. Alternate drive currents in Table 3 are provided for reference only and are not a guarantee of performance.
2. Bridgelux maintains a ± 7% tolerance on flux measurements.
3. Typical stabilized DC performance values are provided as reference only and are not a guarantee of performance.

Performance at Commonly Used Drive Currents

Table 3: Product Performance at Commonly Used Drive Currents (Continued)

Part Number	CRI	Drive Current ¹ (mA)	Typical V_f $T_c = 25^\circ\text{C}$ (V)	Typical Power $T_c = 25^\circ\text{C}$ (W)	Typical Flux ² $T_c = 25^\circ\text{C}$ (lm)	Typical DC Flux ³ $T_c = 85^\circ\text{C}$ (lm)	Typical Efficacy $T_c = 25^\circ\text{C}$ (lm/W)
BXRC-50G1001-B-8x-SE	90	100	32.9	3.3	555	499	169
		150	33.6	5.0	810	729	161
		200	34.2	6.8	1065	958	156
		270	35.0	9.5	1394	1255	147
		400	36.5	14.6	1981	1783	136
		500	37.5	18.7	2399	2159	128
BXRC-50G1001-C-8x-SE	90	150	29.8	4.5	752	677	168
		225	30.3	6.8	1097	988	161
		300	30.7	9.2	1436	1292	156
		360	31.1	11.2	1701	1531	152
		600	32.4	19.4	2717	2446	140
		1000	34.3	34.3	4250	3825	124
BXRC-50G1001-D-8x-SE	90	125	24.3	3.0	509	458	168
		185	24.6	4.5	732	659	161
		250	24.9	6.2	969	872	156
		350	25.4	8.9	1326	1194	149
		500	26.1	13.0	1843	1659	141
		1000	28.1	28.1	3402	3062	121
BXRC-57C1001-B-8x-SE	70	100	32.9	3.3	649	584	197
		150	33.6	5.0	948	853	188
		200	34.2	6.8	1246	1121	182
		270	35.0	9.5	1631	1468	172
		400	36.5	14.6	2317	2086	159
		500	37.5	18.7	2807	2526	150
BXRC-57C1001-C-8x-SE	70	150	29.8	4.5	880	792	197
		225	30.3	6.8	1284	1155	188
		300	30.7	9.2	1679	1512	182
		360	31.1	11.2	1990	1791	178
		600	32.4	19.4	3179	2861	164
		1000	34.3	34.3	4972	4475	145
BXRC-57C1001-D-8x-SE	70	125	24.3	3.0	595	536	196
		185	24.6	4.5	856	770	188
		250	24.9	6.2	1134	1021	182
		350	25.4	8.9	1552	1397	175
		500	26.1	13.0	2157	1941	165
		1000	28.1	28.1	3980	3582	142
BXRC-57E1001-B-8x-SE	80	100	32.9	3.3	617	555	187
		150	33.6	5.0	900	810	179
		200	34.2	6.8	1183	1065	173
		270	35.0	9.5	1549	1394	164
		400	36.5	14.6	2201	1981	151
		500	37.5	18.7	2666	2399	142

Notes for Table 3:

1. Alternate drive currents in Table 3 are provided for reference only and are not a guarantee of performance.
2. Bridgelux maintains a $\pm 7\%$ tolerance on flux measurements.
3. Typical stabilized DC performance values are provided as reference only and are not a guarantee of performance.

Performance at Commonly Used Drive Currents

Table 3: Product Performance at Commonly Used Drive Currents (Continued)

Part Number	CRI	Drive Current ¹ (mA)	Typical V_f $T_c = 25^\circ\text{C}$ (V)	Typical Power $T_c = 25^\circ\text{C}$ (W)	Typical Flux ² $T_c = 25^\circ\text{C}$ (lm)	Typical DC Flux ³ $T_c = 85^\circ\text{C}$ (lm)	Typical Efficacy $T_c = 25^\circ\text{C}$ (lm/W)
BXRC-57E1001-C-8x-SE	80	150	29.8	4.5	836	752	187
		225	30.3	6.8	1219	1097	179
		300	30.7	9.2	1595	1436	173
		360	31.1	11.2	1890	1701	169
		600	32.4	19.4	3019	2717	155
		1000	34.3	34.3	4722	4250	137
BXRC-57E1001-D-8x-SE	80	125	24.3	3.0	565	509	186
		185	24.6	4.5	813	732	179
		250	24.9	6.2	1077	969	173
		350	25.4	8.9	1474	1326	166
		500	26.1	13.0	2048	1843	157
		1000	28.1	28.1	3780	3402	135
BXRC-65C1001-B-8x-SE	70	100	32.9	3.3	649	584	197
		150	33.6	5.0	948	853	188
		200	34.2	6.8	1246	1121	182
		270	35.0	9.5	1631	1468	172
		400	36.5	14.6	2317	2086	159
		500	37.5	18.7	2807	2526	150
BXRC-65C1001-C-8x-SE	70	150	29.8	4.5	880	792	197
		225	30.3	6.8	1284	1155	188
		300	30.7	9.2	1679	1512	182
		360	31.1	11.2	1990	1791	178
		600	32.4	19.4	3179	2861	164
		1000	34.3	34.3	4972	4475	145
BXRC-65C1001-D-8x-SE	70	125	24.3	3.0	595	536	196
		185	24.6	4.5	856	770	188
		250	24.9	6.2	1134	1021	182
		350	25.4	8.9	1552	1397	175
		500	26.1	13.0	2157	1941	165
		1000	28.1	28.1	3980	3582	142
BXRC-65E1001-B-8x-SE	80	100	32.9	3.3	624	561	190
		150	33.6	5.0	911	820	181
		200	34.2	6.8	1197	1077	175
		270	35.0	9.5	1568	1411	166
		400	36.5	14.6	2227	2004	153
		500	37.5	18.7	2697	2427	144
BXRC-65E1001-C-8x-SE	80	150	29.8	4.5	845	761	189
		225	30.3	6.8	1234	1110	181
		300	30.7	9.2	1614	1452	175
		360	31.1	11.2	1912	1721	171
		600	32.4	19.4	3055	2749	157
		1000	34.3	34.3	4777	4300	139

Notes for Table 3:

1. Alternate drive currents in Table 3 are provided for reference only and are not a guarantee of performance.
2. Bridgelux maintains a $\pm 7\%$ tolerance on flux measurements.
3. Typical stabilized DC performance values are provided as reference only and are not a guarantee of performance.

Performance at Commonly Used Drive Currents

Table 3: Product Performance at Commonly Used Drive Currents (Continued)

Part Number	CRI	Drive Current ¹ (mA)	Typical V_f $T_c = 25^\circ\text{C}$ (V)	Typical Power $T_c = 25^\circ\text{C}$ (W)	Typical Flux ² $T_c = 25^\circ\text{C}$ (lm)	Typical DC Flux ³ $T_c = 85^\circ\text{C}$ (lm)	Typical Efficacy $T_c = 25^\circ\text{C}$ (lm/W)
BXRC-65E1001-D-8x-SE	80	125	24.3	3.0	572	515	188
		185	24.6	4.5	823	740	181
		250	24.9	6.2	1090	981	175
		350	25.4	8.9	1491	1342	168
		500	26.1	13.0	2072	1865	159
		1000	28.1	28.1	3824	3442	136

Notes for Table 3:

1. Alternate drive currents in Table 3 are provided for reference only and are not a guarantee of performance.
2. Bridgelux maintains a $\pm 7\%$ tolerance on flux measurements.
3. Typical stabilized DC performance values are provided as reference only and are not a guarantee of performance.

Electrical Characteristics

Table 4: Electrical Characteristics

Part Number	Drive Current (mA)	Forward Voltage Pulsed, $T_c = 25^\circ\text{C}$ (V) ^{1, 2, 3, 8}			Typical Coefficient of Forward Voltage ⁴ $\Delta V_f / \Delta T_c$ (mV/ $^\circ\text{C}$)	Typical Thermal Resistance Junction to Case ^{5,6} R_{j-c} ($^\circ\text{C}/\text{W}$)	Driver Selection Voltages ⁷ (V)	
		Minimum	Typical	Maximum			V_f Min. Hot $T_c = 105^\circ\text{C}$ (V)	V_f Max. Cold $T_c = -40^\circ\text{C}$ (V)
BXRC-xxx100x-B-8x-SE	200	31.6	34.2	36.8	-11.03	0.62	30.8	37.5
	500	34.7	37.5	40.3	-12.10	0.95	33.7	41.1
BXRC-xxx100x-C-8x-SE	300	28.4	30.7	33.0	-9.90	0.38	27.6	33.6
	1000	32.4	35	37.6	-11.29	0.55	31.5	38.4
BXRC-xxx100x-D-8x-SE	250	23.0	24.9	26.8	-8.03	0.37	22.4	27.3
	1000	26.9	29.1	31.3	-9.39	0.55	26.2	31.9

Notes for Table 4:

- Parts are tested in pulsed conditions, $T_c = 25^\circ\text{C}$. Pulse width is 10ms.
- Voltage minimum and maximum are provided for reference only and are not a guarantee of performance.
- Bridgelux maintains a tester tolerance of $\pm 0.10\text{V}$ on forward voltage measurements.
- Typical coefficient of forward voltage tolerance is $\pm 0.1\text{mV}$ for nominal current.
- Thermal resistance values are based from test data of a 3000K 80 CRI product.
- Thermal resistance value was calculated using total electrical input power; optical power was not subtracted from input power. The thermal interface material used during testing is not included in the thermal resistance value.
- V_f min hot and max cold values are provided as reference only and are not guaranteed by test. These values are provided to aid in driver design and selection over the operating range of the product.
- This product has been designed and manufactured per IEC 62031:2018. This product has passed dielectric withstand voltage testing at 1140 V. The working voltage designated for the insulation is 70V d.c. The maximum allowable voltage across the array must be determined in the end product application.

Eye Safety

Table 5: Eye Safety Risk Group (RG) Classifications

Part Number	Drive Current (mA)	CCT			
		2700K/3000K	4000K ²	5000K ³	6500K ⁴
BXRC-xxx100x-B-8x-SE	355	RG1	RG1	RG1	RG1
	500	RG1	RG1	RG1	RG2
BXRC-xxx100x-C-8x-SE	395	RG1	RG1	RG1	RG1
	550	RG1	RG1	RG1	RG2
	730	RG1	RG1	RG2	RG2
	1000	RG1	RG2	RG2	RG2
BXRC-xxx100x-D-8x-SE	490	RG1	RG1	RG1	RG1
	680	RG1	RG1	RG1	RG2
	900	RG1	RG1	RG2	RG2
	1000	RG1	RG2	RG2	RG2

Notes for Table 5:

1. Eye safety classification for the use of Bridgelux Vero Series LED arrays is in accordance with specification IEC/TR 62778: Application of IEC 62471 for the assessment of blue light hazard to light sources and luminaires.
2. For products classified as RG2 at 4000K, Ethr= 1980 lx.
3. For products classified as RG2 at 5000K Ethr= 1530 lx.
4. For products classified as RG2 at 6500K, Ethr= 1170 lx.
5. Please contact your Bridgelux sales representative for Ethr values at specific drive currents and CCTs not listed.

Absolute Maximum Ratings

Table 6 Maximum Ratings

Parameter	Maximum Rating		
LED Junction Temperature (T_j)	150°C		
Storage Temperature	-40°C to +105°C		
Operating Case Temperature ¹ (T_c)	105°C		
Soldering Temperature ²	300°C or lower for a maximum of 6 seconds		
	BXRC-xxx100x-B-8x-SE	BXRC-xxx100x-C-8x-SE	BXRC-xxx100x-D-8x-SE
Maximum Drive Current ³	500 mA	1000 mA	1000 mA
Maximum Peak Pulsed Drive Current ⁴	560 mA	1120 mA	1120 mA
Maximum Reverse Voltage ⁵	-60V	-55V	-45V

Notes for Table 6:

1. For IEC 62717 requirement, please consult your Bridgelux sales representative.
2. Refer to Bridgelux Application Note AN120: Bridgelux Vero SE Array Design Guide.
3. Arrays may be driven at higher currents however lumen maintenance may be reduced and warranty will not apply.
4. Bridgelux recommends a maximum duty cycle of 10% and pulse width of 20 ms when operating LED Arrays at maximum peak pulsed current specified. Maximum peak pulsed currents indicate values where LED Arrays can be driven without catastrophic failures.
5. Light emitting diodes are not designed to be driven in reverse voltage and will not produce light under this condition. Maximum rating provided for reference only.

Performance Curves

Figure 1: Vero SE 10B Drive Current vs. Voltage

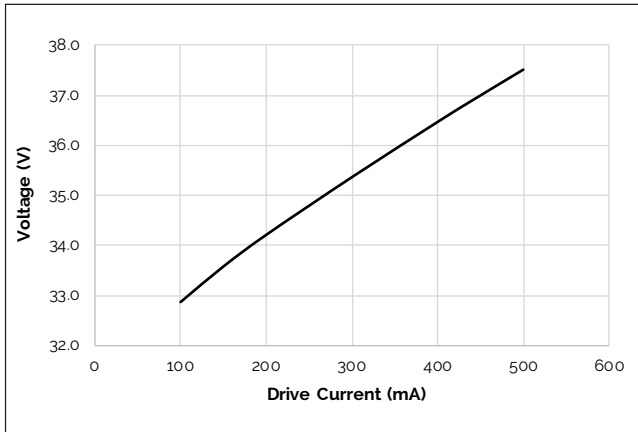

Figure 2: Vero 10C SE Drive Current vs. Voltage

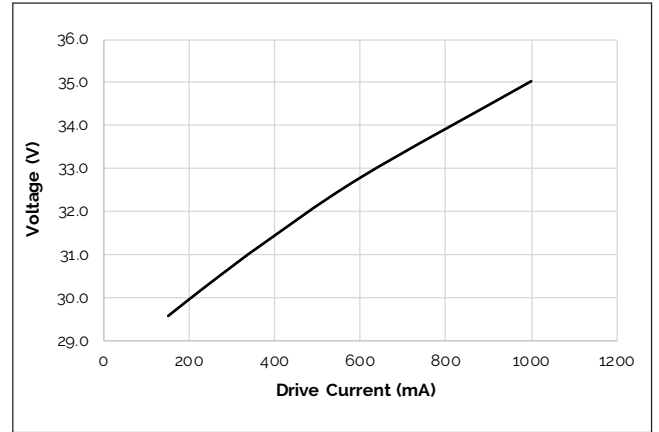

Figure 3: Vero SE 10D Drive Current vs. Voltage

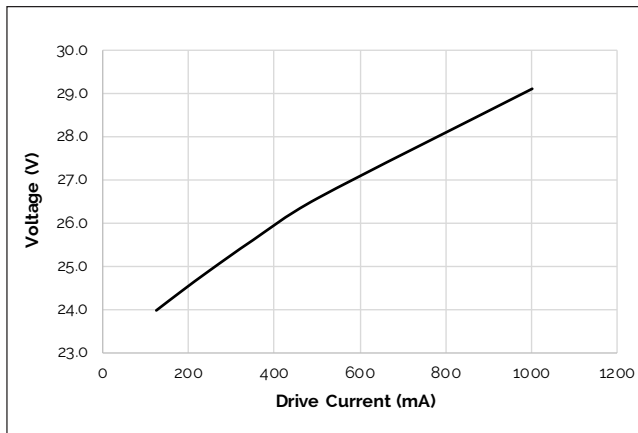

Figure 4: Vero SE 10B Typical Relative Flux vs. Current

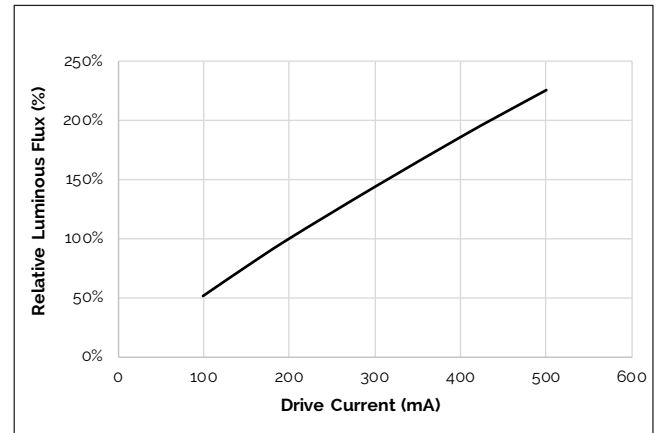

Figure 5: Vero SE 10C Typical Relative Flux vs. Current

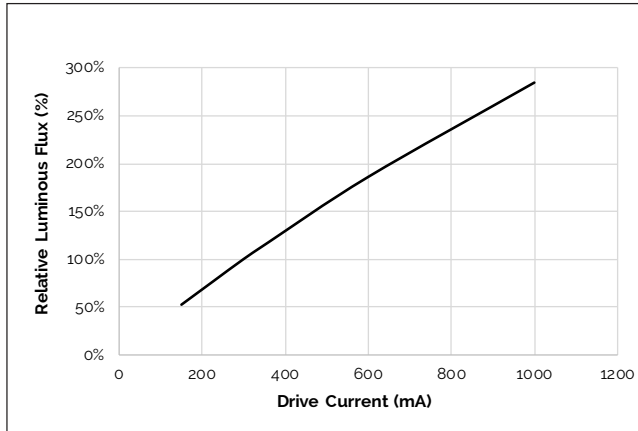
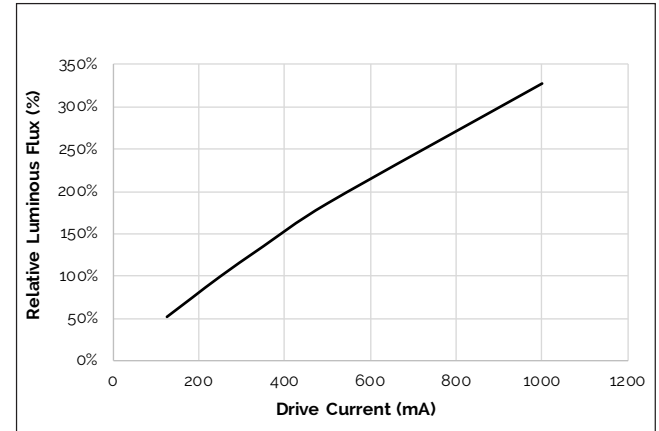

Figure 6 Vero SE 10D Typical Relative Flux vs. Current



Notes for Figure 1-6:

1. Bridgelux does not recommend driving high power LEDs at low currents. Doing so may produce unpredictable results. Pulse width modulation (PWM) is recommended for dimming effects.
2. Products tested under pulsed condition (10ms pulse width) at nominal test current where T_j (junction temperature) - T_c (case temperature) = 25°C.

Performance Curves

Figure 7: Typical DC Flux vs. Case Temperature

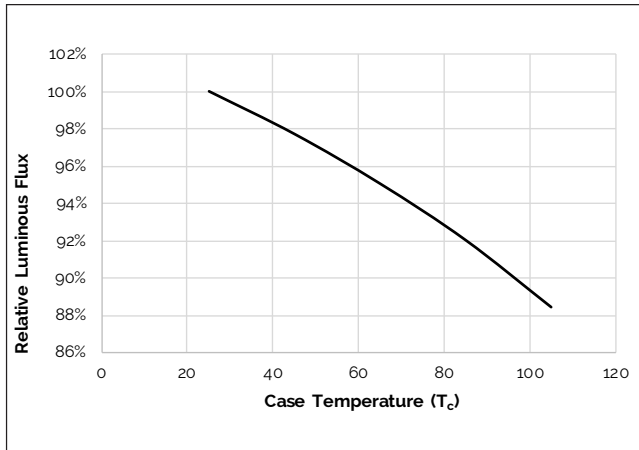

Figure 8: Typical DC ccy Shift vs. Case Temperature

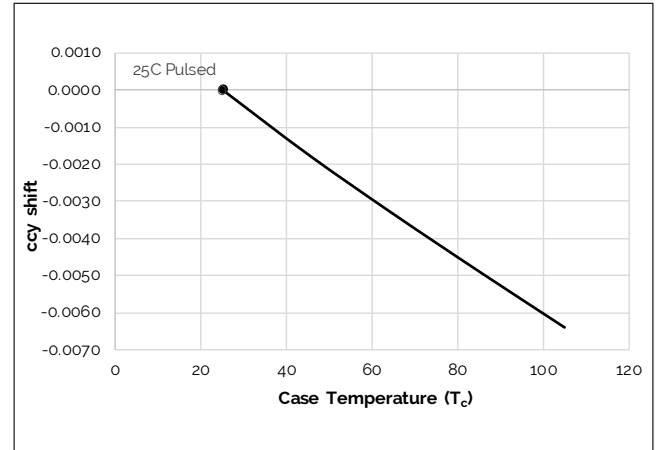
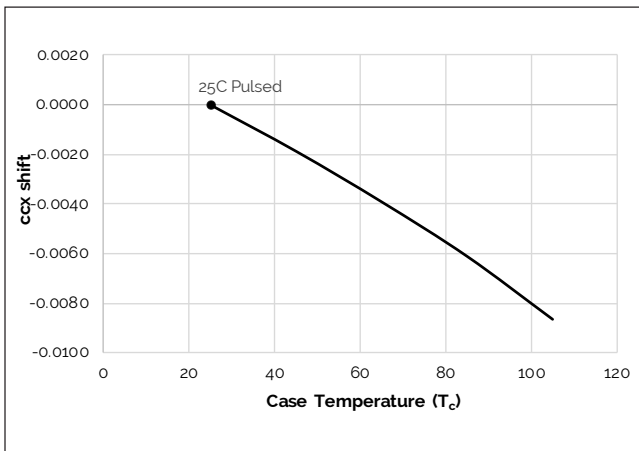

Figure 9: Typical DC ccx Shift vs. Case Temperature



Note for Figures 7-9:
1. Characteristics shown for Warm White.

Typical Radiation Pattern

Figure 10: Typical Spatial Radiation Pattern

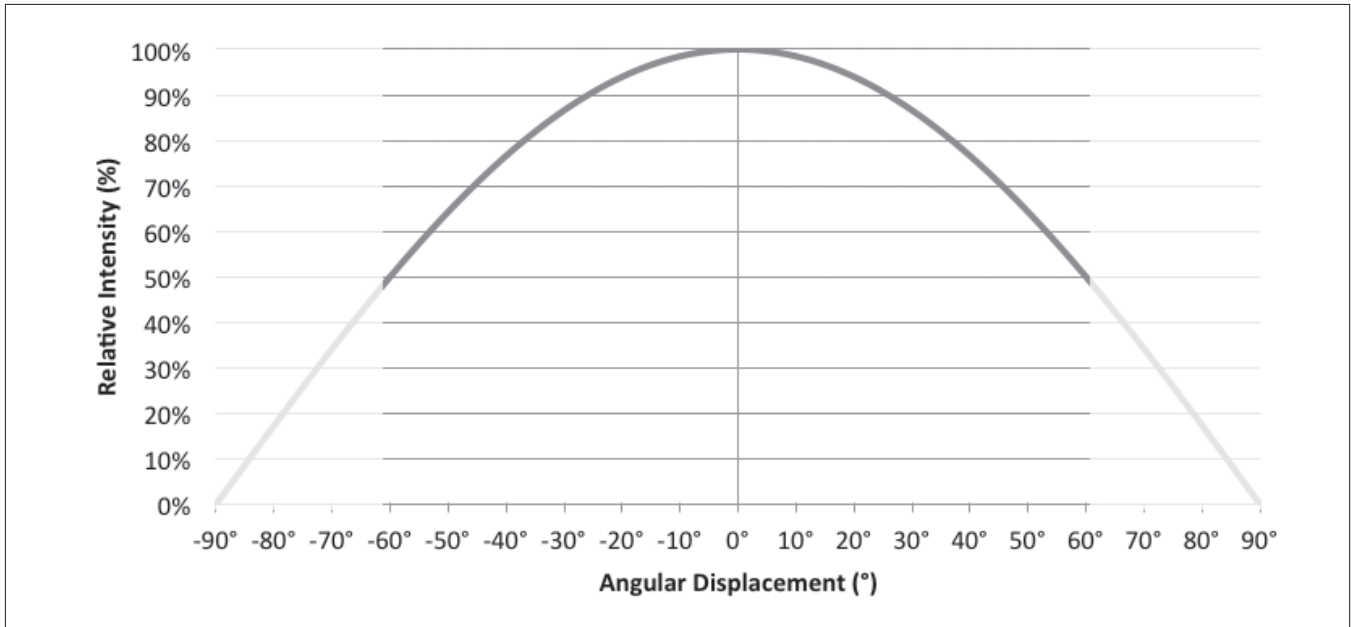

Notes for Figure 10:

1. Typical viewing angle is 120°.
2. The viewing angle is defined as the off axis angle from the centerline where intensity is ½ of the peak value.

Figure 11: Typical Polar Radiation Pattern

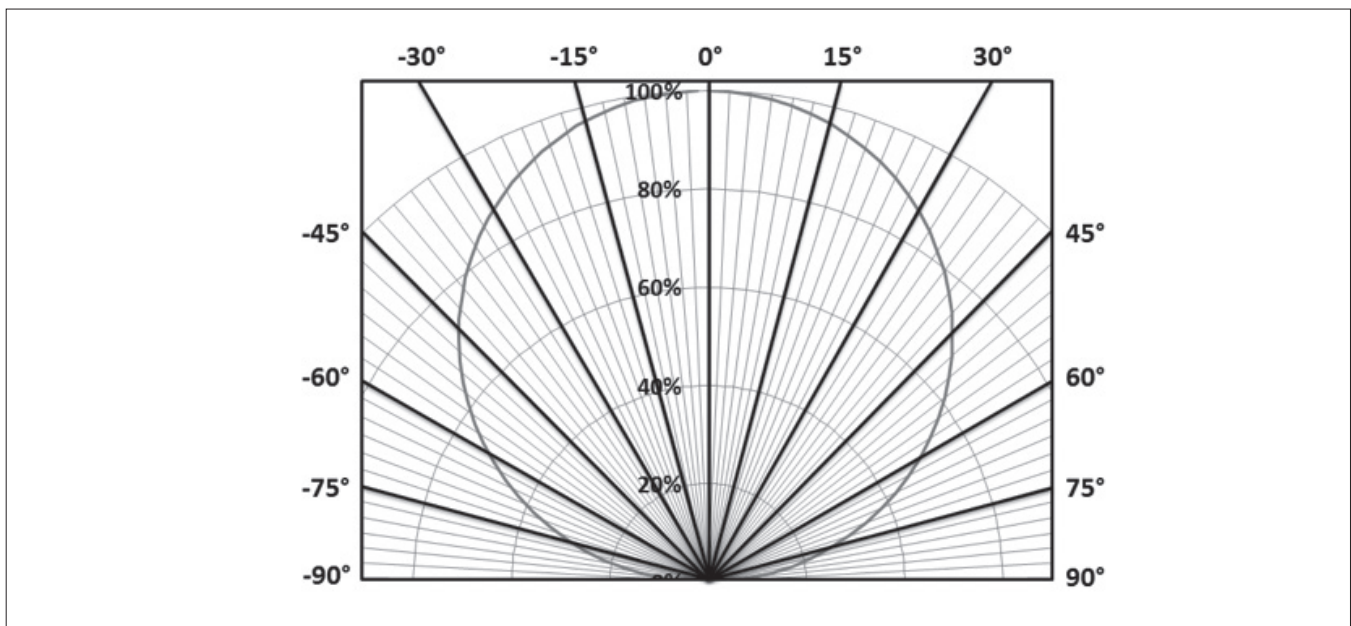

Typical Color Spectrum

Figure 12: Typical Color Spectrum

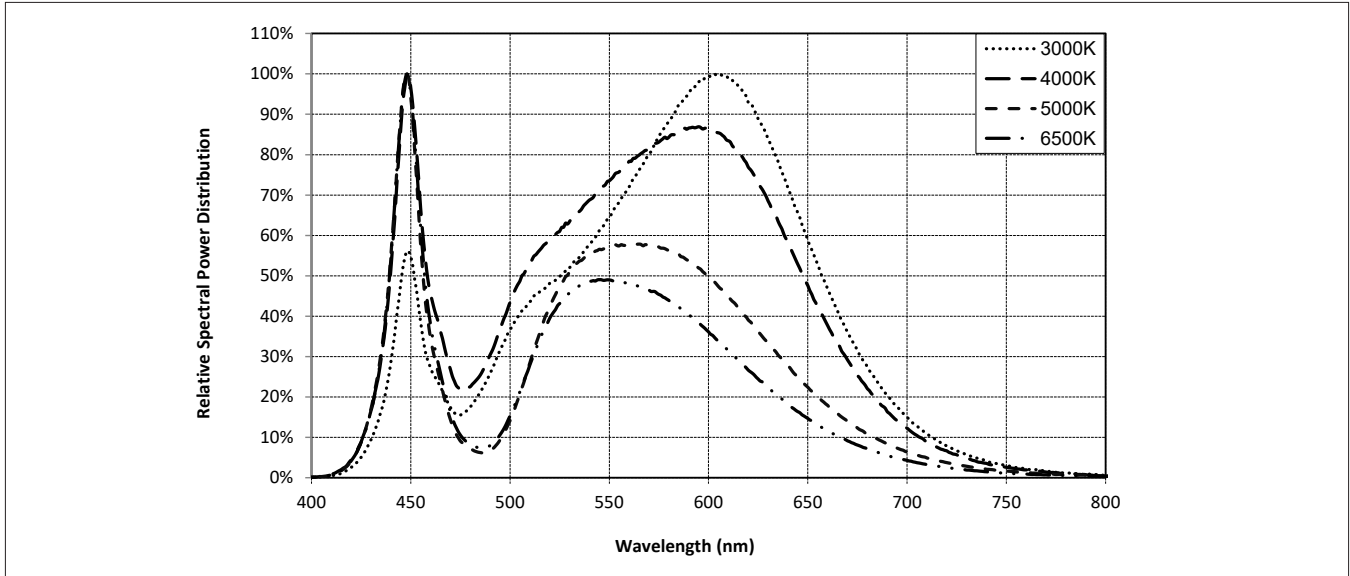

Notes for Figure 12:

1. Color spectra measured at nominal current for $T_j = T_c = 25^\circ\text{C}$.
2. Color spectra shown is 3000K and 80 CRI.
3. Color spectra shown is 4000K and 80 CRI.
4. Color spectra shown is 5000K and 70 CRI.
4. Color spectra shown is 6500K and 70 CRI.

Mechanical Dimensions

Figure 13: Drawing for Vero SE 10 LED Array

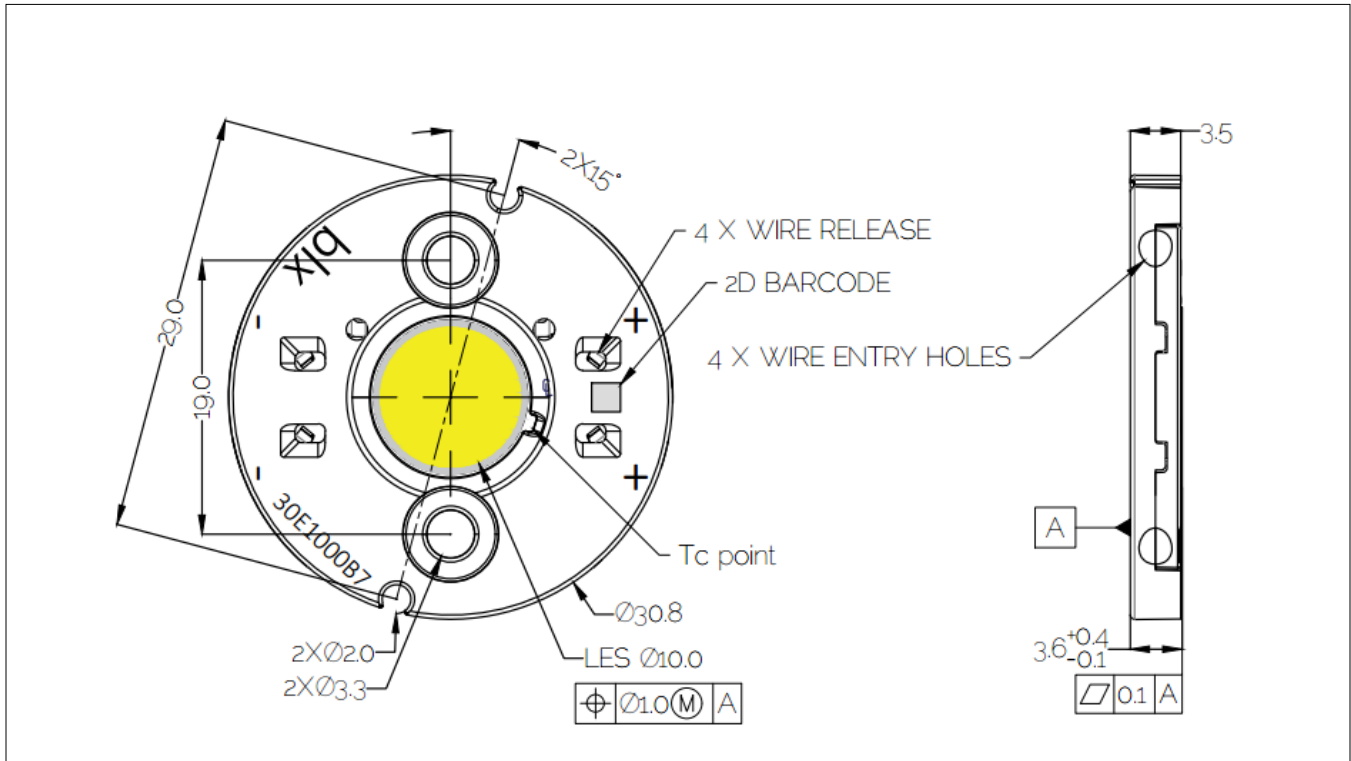

Notes for Figure 13:

1. Drawings are not to scale.
2. Drawing dimensions are in millimeters.
3. Unless otherwise specified, tolerances are ± 0.1 mm.
4. Mounting holes (2X) are for M3 screws.
5. Bridgelux recommends two tapped holes for mounting screws with 29 ± 0.10 mm center-to-center spacing.
6. Screws with flat shoulders (pan, dome, button, round, truss, mushroom) provide optimal torque control. Do NOT use flat, countersink, or raised head screws.
7. The optical center of the LED Array is nominally defined by the mechanical center of the array to a tolerance of ± 0.2 mm.
8. Bridgelux maintains a flatness of 0.10mm across the mounting surface of the array

Color Binning Information

Figure 14: Warm and Neutral White Test Bins in xy Color Space

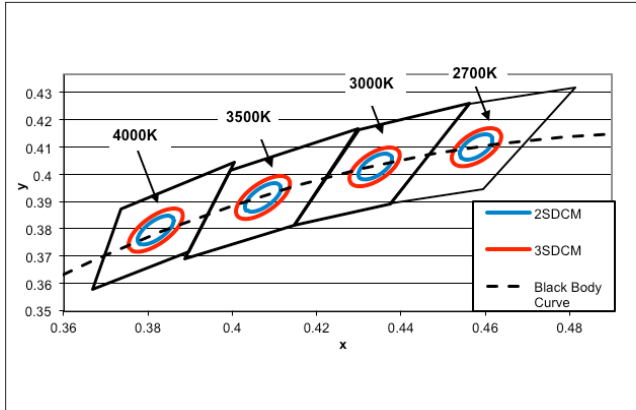

Note: Pulsed Test Conditions, $T_c = 25^\circ\text{C}$

Figure 15: Graph of Cool White Test Bins in xy Color Space

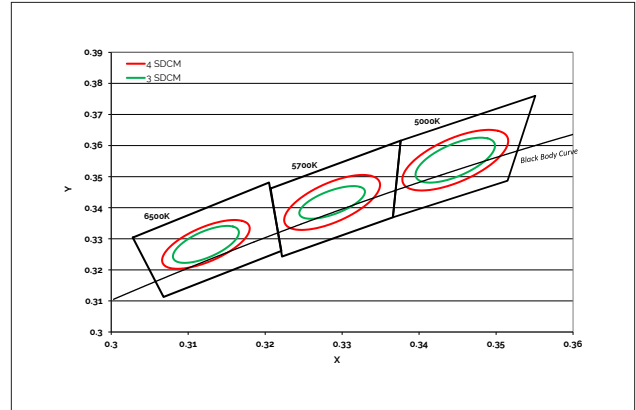

Note: Pulsed Test Conditions, $T_c = 25^\circ\text{C}$

Table 7: Warm and Neutral White xy Bin Coordinates and Associated Typical CCT

Bin Code	2700K	3000K	3500K	4000K
ANSI Bin (for reference only)	(2580K - 2870K)	(2870K - 3220K)	(3220K - 3710K)	(3710K - 4260K)
83 (3 SDCM)	(2651K - 2794K)	(2968K - 3136K)	(3369K - 3586K)	(3851K - 4130K)
82 (2 SDCM)	(2674K - 2769K)	(2995K - 3107K)	(3404K - 3548K)	(3895K - 4081K)
Center Point (x,y)	(0.4578, 0.4101)	(0.4338, 0.403)	(0.4073, 0.3917)	(0.3818, 0.3797)

Table 8: Cool White xy Bin Coordinates and Associated Typical CCT (product is hot targeted to $T_c = 85^\circ\text{C}$)

Bin Code	5000K	5700K	6500K
ANSI Bin (for reference only)	(4745K - 5311K)	(5312K - 6022K)	(6022K - 7042K)
84 (4 SDCM)	(4801K - 5282K)	(5395K - 5970K)	(6200K - 6910K)
83 (3 SDCM)	(4835K - 5215K)	(5460K - 5891K)	(6279K - 6811K)
Center Point (x,y)	(0.3447, 0.3553)	(0.3287, 0.3417)	(0.3123, 0.3282)

Note for Tables 7-8:

1. Bridgelux maintains a tolerance of +/- 0.007 on x and y color coordinates in the CIE 1931 color Space.

Packaging and Labeling

Figure 16: Drawing for Vero SE 10 Packaging Tray

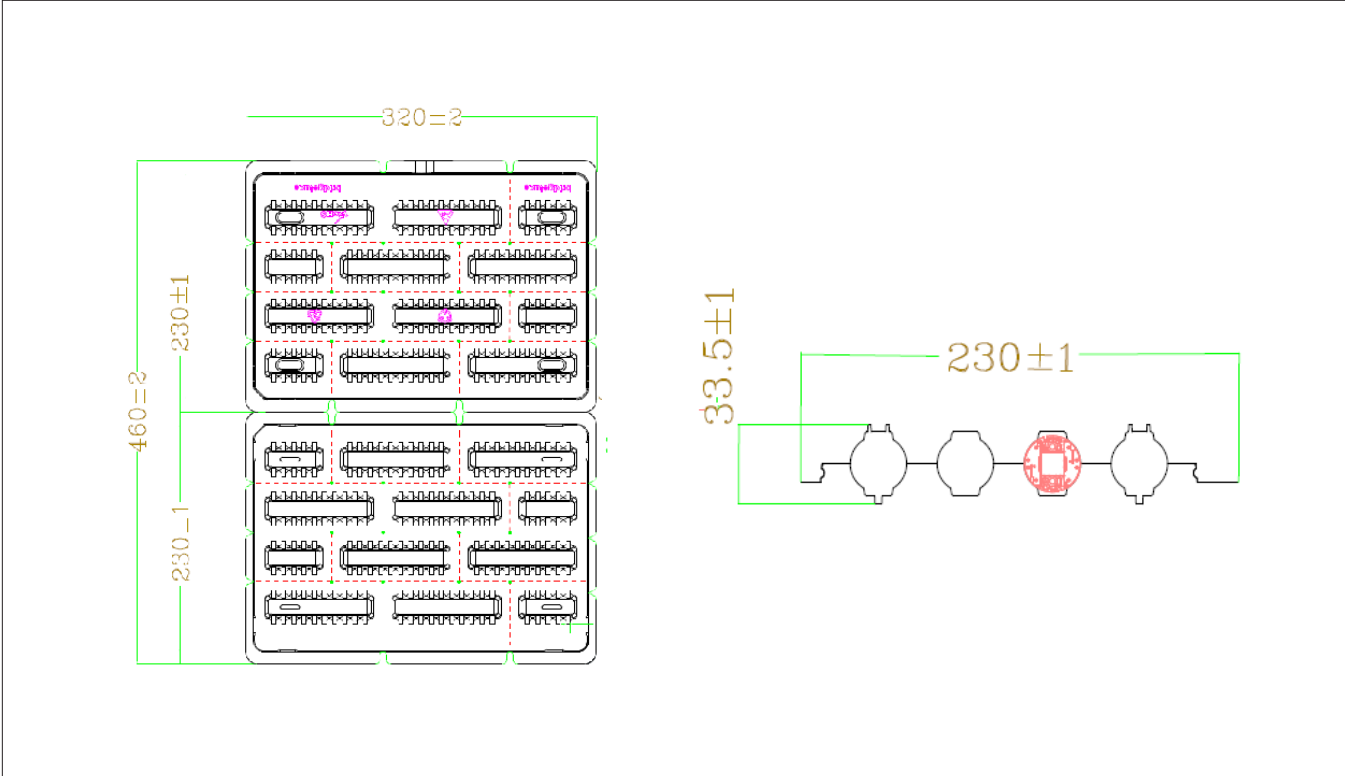

- Notes for Figure 16:
- 1. Dimensions are in millimeters.
 - 2. Drawings are not to scale.

Packaging and Labeling

Figure 17: Vero SE Series Packaging and Labeling

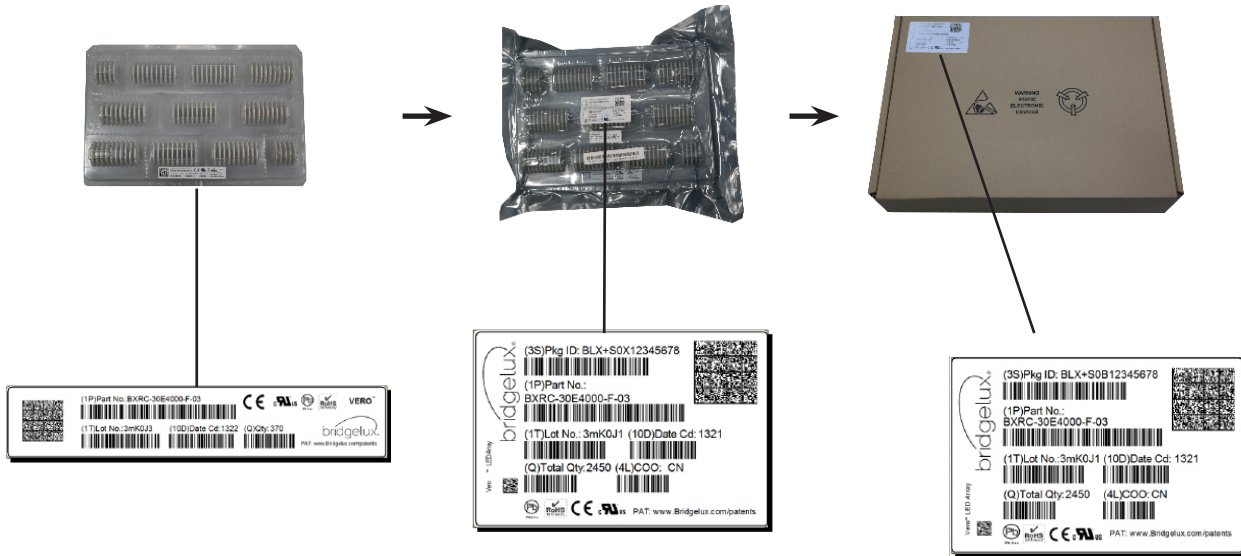

Notes for Figure 17:

1. Each tray holds 200 COBs.
2. Each tray is vacuum sealed in an anti-static bag and placed in its own box.
3. Each tray, bag and box is to be labeled as shown above.

Figure 18: Vero SE Product Labeling

Bridgelux COB arrays have laser markings on the back side of the substrate to help with product identification. In addition to the product identification markings, Bridgelux COB arrays also contain markings for internal Bridgelux manufacturing use only. The image below shows which markings are for customer use and which ones are for Bridgelux internal use only. The Bridgelux internal manufacturing markings are subject to change without notice, however these will not impact the form, function or performance of the COB array.



Customer Use- 2D Barcode
Scannable barcode provides product part number, V_i bin and other Bridgelux internal production information.

Customer Use- Product part number

30E1000C 82 2F

Customer Use- V_i Bin Code included to enable greater luminaire design flexibility. Refer to ANG2 for bin code definitions.

Design Resources

Application Notes

Bridgelux has developed a comprehensive set of application notes and design resources to assist customers in successfully designing with the Vero product family of LED array products. For all available application notes visit www.bridgelux.com.

Optical Source Models

Optical source models and ray set files are available for all Bridgelux products. For a list of available formats, visit www.bridgelux.com.

3D CAD Models

Three dimensional CAD models depicting the product outline of all Bridgelux Vero LED arrays are available in both IGS and STEP formats. Please contact your Bridgelux sales representative for assistance.

LM80

LM80 testing has been completed and the LM80 report is now available. Please contact your Bridgelux sales representative for LM-80 report.

Precautions

CAUTION: CHEMICAL EXPOSURE HAZARD

Exposure to some chemicals commonly used in luminaire manufacturing and assembly can cause damage to the LED array. Please consult Bridgelux Application Note AN120 for additional information.

CAUTION: RISK OF BURN

Do not touch the Vero LED array during operation. Allow the array to cool for a sufficient period of time before handling. The Vero LED array may reach elevated temperatures such that could burn skin when touched.

CAUTION

CONTACT WITH LIGHT EMITTING SURFACE (LES)

Avoid any contact with the LES. Do not touch the LES of the LED array or apply stress to the LES (yellow phosphor resin area). Contact may cause damage to the LED array.

Optics and reflectors must not be mounted in contact with the LES (yellow phosphor resin area). Optical devices may be mounted on the top surface of the plastic housing of the Vero LED array. Use the mechanical features of the LED array housing, edges and/or mounting holes to locate and secure optical devices as needed.

Disclaimers

MINOR PRODUCT CHANGE POLICY

The rigorous qualification testing on products offered by Bridgelux provides performance assurance. Slight cosmetic changes that do not affect form, fit, or function may occur as Bridgelux continues product optimization.

STANDARD TEST CONDITIONS

Unless otherwise stated, array testing is performed at the nominal drive current.

About Bridgelux: Bridging Light and Life™

At Bridgelux, we help companies, industries and people experience the power and possibility of light. Since 2002, we've designed LED solutions that are high performing, energy efficient, cost effective and easy to integrate. Our focus is on light's impact on human behavior, delivering products that create better environments, experiences and returns—both experiential and financial. And our patented technology drives new platforms for commercial and industrial luminaires.

For more information about the company, please visit
bridgelux.com
twitter.com/Bridgelux
facebook.com/Bridgelux
youtube.com/user/Bridgelux
linkedin.com/company/bridgelux-inc-_2
WeChat ID: BridgeluxInChina



46410 Fremont Boulevard
Fremont, CA 94538 U.S.A.
Tel (925) 583-8400
www.bridgelux.com

© 2021 Bridgelux, Inc. All rights reserved. Product specifications are subject to change without notice. Bridgelux, the Bridgelux stylized logo design, Vero, V Series and V Series HD are registered trademarks, and Decor Series is a trademark of Bridgelux, Inc. All other trademarks are the property of their respective owners.

Bridgelux Gen 8 Vero SE 10 Array Series Product Data Sheet DS430 Rev. B (07/2021)