



PRECISION MICROPPOWER CMOS OPERATIONAL AMPLIFIER

GENERAL DESCRIPTION

The ALD1731A/ALD1731 is a precision, low cost, monolithic CMOS micropower high slew rate operational amplifier intended for a broad range of analog applications using $\pm 1V$ to $\pm 5V$ dual power supply systems, as well as $+2V$ to $+10V$ battery operated systems. All device characteristics are specified for $+5V$ single supply or $\pm 2.5V$ dual supply systems. Supply current is $250\mu A$ maximum at $5V$ supply voltage. It is manufactured with Advanced Linear Devices' enhanced EPAD[®] silicon gate CMOS process.

The ALD1731A/ALD1731 features extremely low input power requirements, practically removing any loading effects on high source impedance signal sources such as capacitive sensors. These devices do not add any significant errors, regardless of what the source impedance variations may be, thereby improving overall system precision and accuracy. The device is designed to offer the benefits of CMOS technology by providing a wide range of desired specifications. The most important of these specifications is extremely low input bias/offset currents at extremely low input offset voltages. It has been developed specifically for the $+5V$ single supply or $\pm 1V$ to $\pm 5V$ dual supply user and offers the popular industry standard pin configuration of $\mu A741$ and ICL7611 types.

Several additional important characteristics of the device make application easier to implement at those voltages. First, the operational amplifier can operate with rail to rail input and output voltages. This means the signal input voltage and output voltage can be equal to the positive and negative supply voltages. This feature allows numerous analog serial stages and flexibility in input signal bias levels. Second, the device was designed to accommodate mixed applications where digital and analog circuits may operate off the same power supply or battery. Third, the output stage can typically drive up to $50pF$ capacitive and $10K\Omega$ resistive loads.

These features, combined with extremely low input currents, high open loop voltage gain of $100V/mV$, useful bandwidth of $700KHz$, a slew rate of $0.7V/\mu s$, low power dissipation of $0.5mW$, low offset voltage and temperature drift, make the ALD1731A/ALD1731 a versatile, micropower operational amplifier.

The ALD1731A/ALD1731, designed and fabricated with silicon gate CMOS technology, offers $0.01pA$ typical input bias current. On chip offset voltage trimming, using EPAD technology, allows the device to be used without nulling. Additionally, robust design and rigorous screening make this device especially suitable for operation in temperature-extreme environments and rugged conditions.

ORDERING INFORMATION ("L" suffix denotes lead-free (RoHS))

Operating Temperature Range		
$0^{\circ}C$ to $+70^{\circ}C$	$0^{\circ}C$ to $+70^{\circ}C$	$-55^{\circ}C$ to $+125^{\circ}C$
8-Pin Small Outline Package (SOIC)	8-Pin Plastic Dip Package	8-Pin CERDIP Package
ALD1731ASAL	ALD1731APAL	
ALD1731SAL	ALD1731PAL	
ALD1731ASA		ALD1731ADA
ALD1731SA		ALD1731DA

* Contact factory for leaded (non-RoHS) or high temperature versions.

FEATURES & BENEFITS

- Extremely low input offset voltages -- $35\mu V$ typical
- Extremely low input bias currents -- $0.01pA$ typical
- All parameters specified for $+5V$ single supply or $\pm 2.5V$ dual supply systems
- Rail to rail input and output voltage ranges
- No frequency compensation required -- unity gain stable
- Ideal for high source impedance applications
- Dual power supplies $\pm 1.0V$ to $\pm 5.0V$
- Single power supply $+2.0V$ to $+10.0V$
- High voltage gain -- typically $100V/mV$ @ $\pm 2.5V(100dB)$
- Drive as low as $10K\Omega$ load
- Output short circuit protected
- Unity gain bandwidth of $0.7MHz$
- Slew rate of $0.7V/\mu s$
- Micropower dissipation
- Suitable for rugged, temperature-extreme environments

APPLICATIONS

- Voltage amplifier
- Voltage follower/buffer
- Charge integrator
- Photodiode amplifier
- Data acquisition systems
- High performance portable instruments
- Signal conditioning circuits
- Sensor and transducer amplifiers
- Low leakage amplifiers
- Active filters
- Sample/Hold amplifier
- Picoammeter
- Current to voltage converter

PIN CONFIGURATION

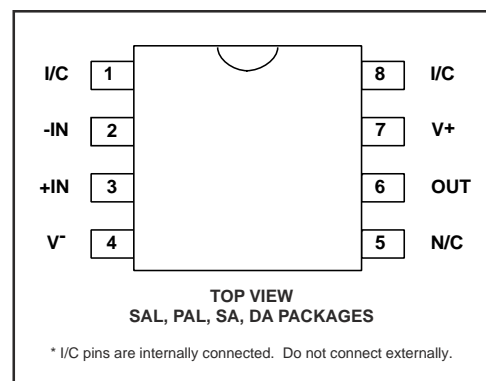

ABSOLUTE MAXIMUM RATINGS

Supply voltage, V+ _____ 10.6V
 Differential input voltage range _____ -0.3V to V+ +0.3V
 Power dissipation _____ 600mW
 Operating temperature range SAL, PAL, SA packages _____ 0°C to +70°C
 DA package _____ -55°C to +125°C
 Storage temperature range _____ -65°C to +150°C
 Lead temperature, 10 seconds _____ +260°C

CAUTION: ESD Sensitive Device. Use static control procedures in ESD controlled environment.

OPERATING ELECTRICAL CHARACTERISTICS

T_A = 25°C V_S = ±2.5V unless otherwise specified

Parameter	Symbol	ALD1731A			ALD1731			Unit	Test Conditions
		Min	Typ	Max	Min	Typ	Max		
Supply Voltage	V _S	±1.0		±5.0	±1.0		±5.0	V	Dual Supply Single Supply
	V+	2.0		10.0	2.0		10.0	V	
Input Offset Voltage	V _{OS}			0.15			0.4	mV	R _S ≤ 100KΩ 0°C ≤ T _A ≤ +70°C
				0.8			1.5	mV	
Input Offset Current	I _{OS}		0.01	10		0.01	10	pA	T _A = 25°C 0°C ≤ T _A ≤ +70°C
				240			240	pA	
Input Bias Current	I _B		0.01	10		0.01	10	pA	T _A = 25°C 0°C ≤ T _A ≤ +70°C
				300			300	pA	
Input Voltage Range	V _{IR}	-0.3		+5.3	-0.3		+5.3	V	V+ = +5V V _S = ±2.5V
		-2.8		+2.8	-2.8		+2.8	V	
Input Resistance	R _{IN}		10 ¹⁴			10 ¹⁴		Ω	
Input Offset Voltage Drift	TCV _{OS}		5			5		μV/°C	R _S ≤ 100KΩ
Power Supply Rejection Ratio	PSRR		90			90		dB	R _S ≤ 100KΩ 0°C ≤ T _A ≤ +70°C
			90			90		dB	
Common Mode Rejection Ratio	CMRR		90			90		dB	R _S ≤ 100KΩ 0°C ≤ T _A ≤ +70°C
			90			90		dB	
Large Signal Voltage Gain	A _V	40	100		32	100		V/mV	R _L = 100KΩ R _L = 1MΩ R _L = 100KΩ, 0°C ≤ T _A ≤ +70°C
			1000			1000		V/mV	
		20			20			V/mV	
Output Voltage Range	V _O low		0.001	0.01		0.001	0.01	V	R _L = 1MΩ, V+ = +5V 0°C ≤ T _A ≤ +70°C
	V _O high	4.99	4.999		4.99	4.999		V	
	V _O low		-2.48	-2.40		-2.48	-2.40	V	
	V _O high	2.40	2.48		2.40	2.48		V	R _L = 100KΩ 0°C ≤ T _A ≤ +70°C
Output Short Circuit Current	I _{SC}		1			1		mA	
Supply Current	I _S		120	180		120	180	μA	V _{IN} = 0V, No Load
Power Dissipation	P _D			0.9			0.9	mW	V _S = ±2.5V
Input Capacitance	C _{IN}		1			1		pF	
Bandwidth	BW		700			700		KHz	
Slew Rate	S _R		0.7			0.7		V/μs	A _V = +1, R _L = 100KΩ

OPERATING ELECTRICAL CHARACTERISTICS (cont'd)

$T_A = 25^\circ\text{C}$ $V_S = \pm 2.5\text{V}$ unless otherwise specified (cont'd)

Parameter	Symbol	ALD1731A			ALD1731			Unit	Test Conditions
		Min	Typ	Max	Min	Typ	Max		
Rise time	t_r		0.2			0.2		μs	$R_L = 100\text{K}\Omega$
Overshoot Factor			20			20		%	$R_L = 100\text{K}\Omega$, $C_L = 50\text{pF}$
Settling Time	t_s		10.0			10.0		μs	0.1%, $A_V = -1$, $R_L = 100\text{K}\Omega, 2$ $C_L = 25\text{pF}$

$T_A = 25^\circ\text{C}$ $V_S = \pm 5.0\text{V}$ unless otherwise specified

Parameter	Symbol	ALD1731A			ALD1731			Unit	Test Conditions
		Min	Typ	Max	Min	Typ	Max		
Power Supply Rejection Ratio	PSRR		90			90		dB	$R_S \leq 100\text{K}\Omega$
Common Mode Rejection Ratio	CMRR		90			90		dB	$R_S \leq 100\text{K}\Omega$
Large Signal Voltage Gain	A_V		250			250		V/mV	$R_L = 100\text{K}\Omega$
Output Voltage Range	$V_{O\text{ low}}$ $V_{O\text{ high}}$	4.90	-4.98 4.98	-4.90	4.90	-4.98 4.98	-4.90	V	$R_L = 100\text{K}\Omega$
Bandwidth	BW		1.0			1.0		MHz	
Slew Rate	SR		1.0			1.0		V/ μs	$A_V = +1$, $C_L = 50\text{pF}$

$V_S = \pm 2.5\text{V}$ $-55^\circ\text{C} \leq T_A \leq +125^\circ\text{C}$ unless otherwise specified

Parameter	Symbol	ALD1731A			ALD1731			Unit	Test Conditions
		Min	Typ	Max	Min	Typ	Max		
Input Offset Voltage	V_{OS}			2.0			3.0	mV	$R_S \leq 100\text{K}\Omega$
Input Offset Current	I_{OS}			2.0			2.0	nA	
Input Bias Current	I_B			2.0			2.0	nA	
Power Supply Rejection Ratio	PSRR		75			75		dB	$R_S \leq 100\text{K}\Omega$
Common Mode Rejection Ratio	CMRR		83			83		dB	$R_S \leq 100\text{K}\Omega$
Large Signal Voltage Gain	A_V		50			50		V/mV	$R_L = 100\text{K}\Omega$
Output Voltage Range	$V_{O\text{ low}}$ $V_{O\text{ high}}$	2.35	-2.47 2.45	-2.40	2.35	-2.47 2.45	-2.40	V V	$R_L = 100\text{K}\Omega$

Design & Operating Notes:

1. The ALD1731A/ALD1731 CMOS operational amplifier uses a 3 gain stage architecture and an improved frequency compensation scheme to achieve large voltage gain, high output driving capability, and better frequency stability. In a conventional CMOS operational amplifier design, compensation is achieved with a pole splitting capacitor together with a nulling resistor. This method is, however, very bias dependent and thus cannot accommodate the large range of supply voltage operation as is required from a stand alone CMOS operational amplifier. The ALD1731A/ALD1731 is internally compensated for unity gain stability using a novel scheme that does not use a nulling resistor. This scheme produces a clean single pole roll off in the gain characteristics while providing for more than 70 degrees of phase margin at the unity gain frequency.
2. The ALD1731A/ALD1731 has complementary p-channel and n-channel input differential stages connected in parallel to accomplish rail to rail common mode input voltage ranges. This means that with the ranges of common mode input voltage close to the power supplies, one of the two differential stages is switched off internally. To maintain compatibility with other operational amplifiers, this switching point has been selected to be about 1.5V below the positive supply voltage. Since offset voltage trimming on the ALD1731A/ALD1731 is made when the input voltage is symmetrical to the supply voltages, this internal switching does not affect a large variety of applications such as an inverting amplifier or non-inverting amplifier with a gain larger than 2.5 (5V operation), where the common mode voltage does not make excursions below this switching point. The user should, however, be aware that this switching does take place if the operational amplifier is connected as a unity gain buffer and should make provisions in the design to allow for input offset voltage variations.
3. The input bias and offset currents are essentially input protection diode reverse bias leakage currents, and are typically 0.01 pA at room temperature. This low input bias current assures that the analog signal from the source will not be distorted by input bias currents.

Normally, this extremely high input impedance of greater than $10^{14}\Omega$ would not be a problem as the source impedance would limit the node impedance. However, for applications where source impedance is very high, it may be necessary to limit noise and hum pickup through proper shielding.

4. The output stage consists of class AB complementary output drivers, capable of driving a low resistance load. The output voltage swing is limited by the drain to source on-resistance of the output transistors as determined by the bias circuitry, and the value of the load resistor. When connected in the voltage follower configuration, the oscillation resistant feature, combined with the rail to rail input and output feature, makes an effective analog signal buffer for medium to high source impedance sensors, transducers, and other circuit networks.
5. The ALD1731A/ALD1731 operational amplifier has been designed to provide full static discharge protection. Internally, the design has been carefully implemented to minimize latch up. However, care must be exercised when handling the device to avoid strong static fields that may degrade a diode junction, causing increased input leakage currents. In using the operational amplifier, the user is advised to power up the circuit before, or simultaneously with, any input voltages applied and to limit input voltages not to exceed 0.3V of the power supply and voltage levels.
6. The ALD1731A/ALD1731, with its micropower operation, offers numerous benefits in reduced power supply requirements, less noise coupling and current spikes, less thermally induced drift, better overall reliability due to lower self heating, and lower input bias current. It requires practically no warm up time as the chip junction heats up to only 0.1°C above ambient temperature under most operating conditions.
7. The ALD1731A/ALD1731 has an internal design architecture that provides robust high temperature operation. Contact factory for custom screening versions.

TYPICAL PERFORMANCE CHARACTERISTICS

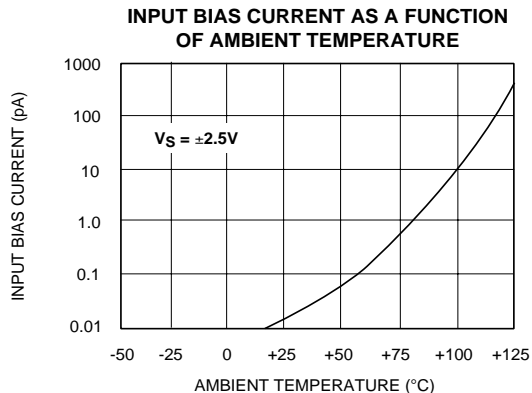
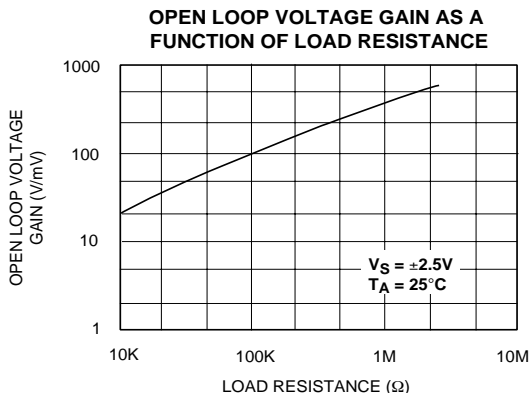
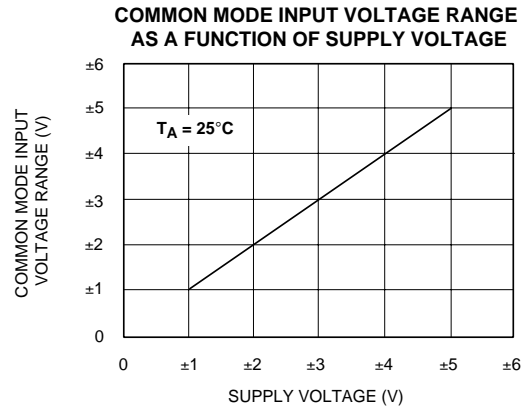
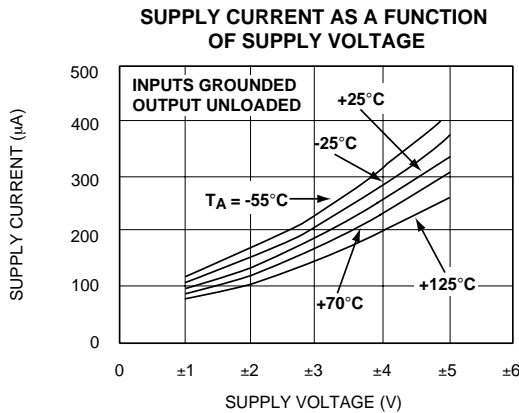

TYPICAL PERFORMANCE CHARACTERISTICS (cont'd)

OPEN LOOP VOLTAGE GAIN AS A FUNCTION OF SUPPLY VOLTAGE AND TEMPERATURE

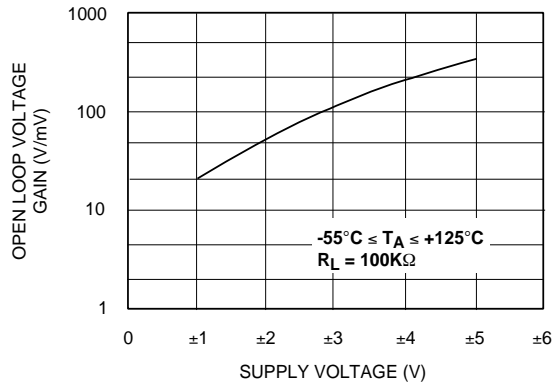

OUTPUT VOLTAGE SWING AS A FUNCTION OF SUPPLY VOLTAGE

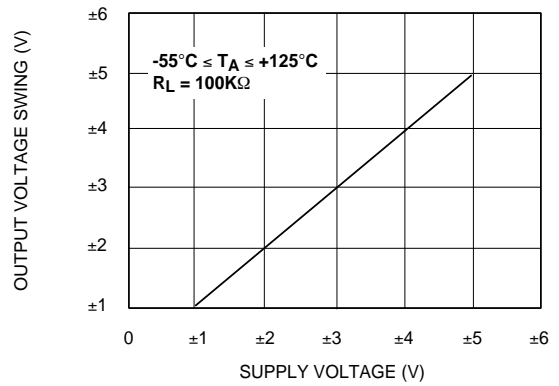

OPEN LOOP VOLTAGE GAIN AS A FUNCTION OF FREQUENCY

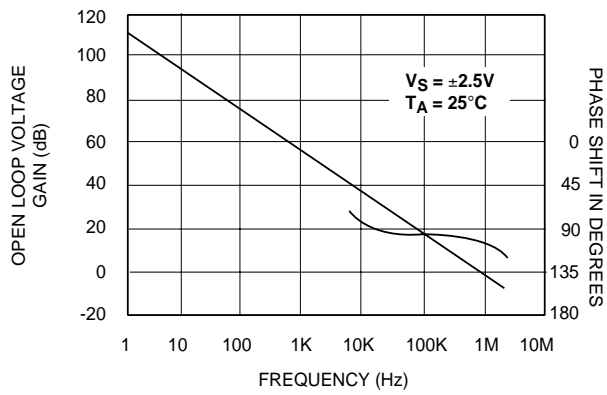

LARGE-SIGNAL TRANSIENT RESPONSE

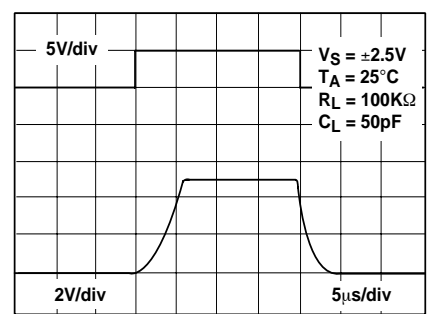

LARGE-SIGNAL TRANSIENT RESPONSE

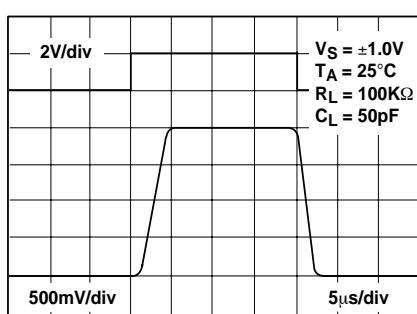

SMALL-SIGNAL TRANSIENT RESPONSE

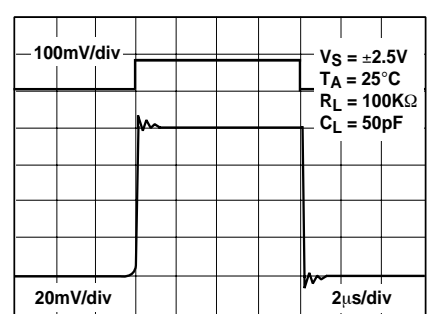

TYPICAL APPLICATIONS

RAIL-TO-RAIL VOLTAGE FOLLOWER/BUFFER

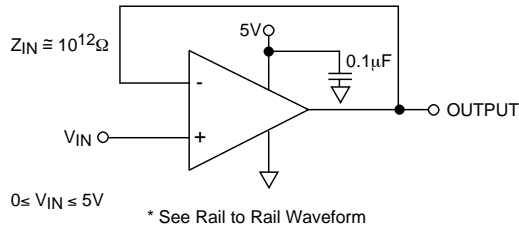

RAIL-TO-RAIL VOLTAGE COMPARATOR

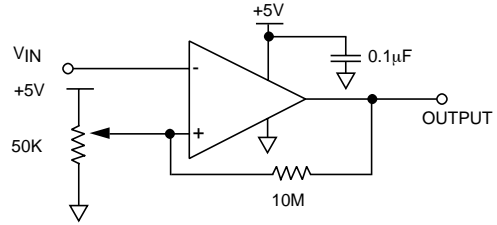

HIGH INPUT IMPEDANCE RAIL-TO-RAIL PRECISION DC SUMMING AMPLIFIER

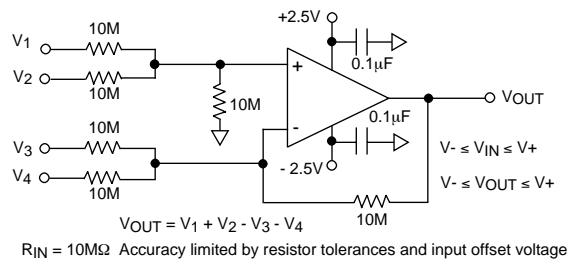

RAIL-TO-RAIL WAVEFORM

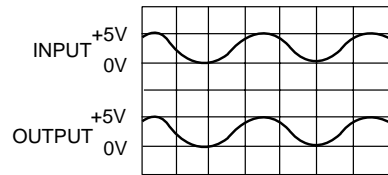

Performance waveforms.
Upper trace is the output of a Wien Bridge Oscillator. Lower trace is the output of Rail-to-rail voltage follower.

WIEN BRIDGE OSCILLATOR (RAIL-TO-RAIL) SINE WAVE GENERATOR

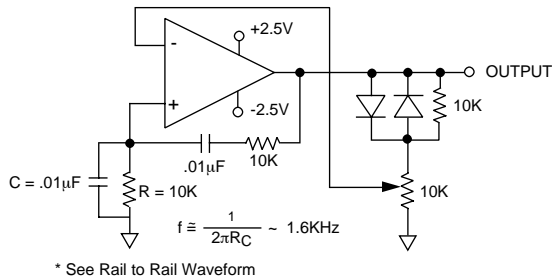
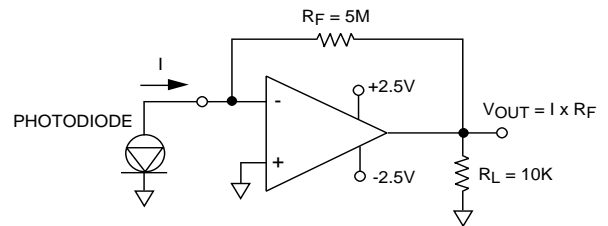
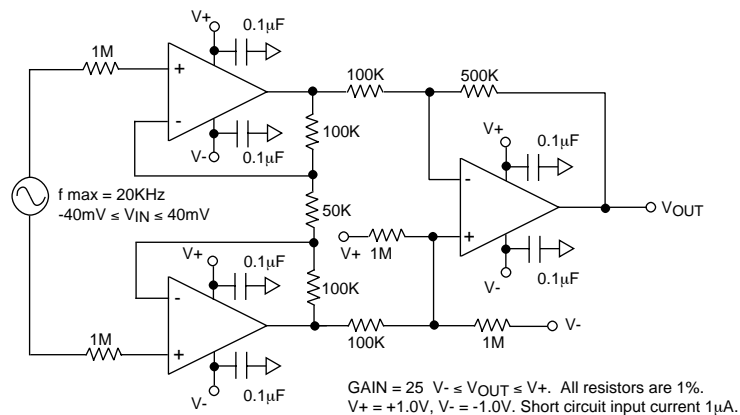

PHOTO DETECTOR CURRENT TO VOLTAGE CONVERTER



LOW VOLTAGE INSTRUMENTATION AMPLIFIER



SOIC-8 PACKAGE DRAWING

8 Pin Plastic SOIC Package

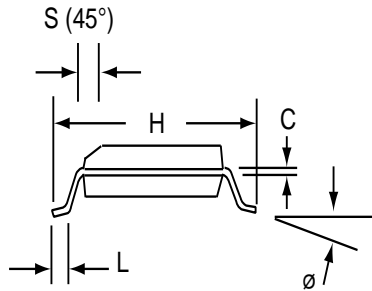
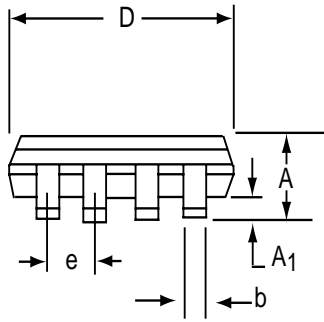
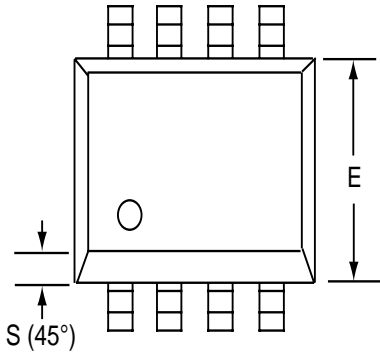

Dim	Millimeters		Inches	
	Min	Max	Min	Max
A	1.35	1.75	0.053	0.069
A ₁	0.10	0.25	0.004	0.010
b	0.35	0.45	0.014	0.018
C	0.18	0.25	0.007	0.010
D-8	4.69	5.00	0.185	0.196
E	3.50	4.05	0.140	0.160
e	1.27 BSC		0.050 BSC	
H	5.70	6.30	0.224	0.248
L	0.60	0.937	0.024	0.037
∅	0°	8°	0°	8°
S	0.25	0.50	0.010	0.020

PDIP-8 PACKAGE DRAWING

8 Pin Plastic DIP Package

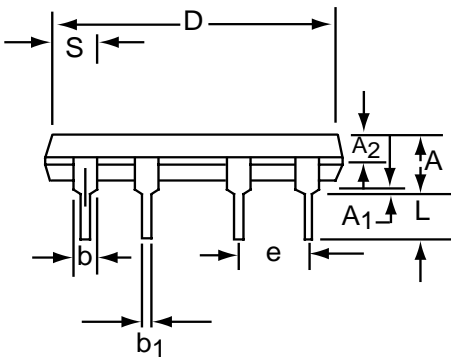
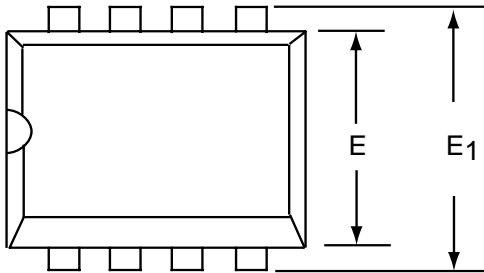

Dim	Millimeters		Inches	
	Min	Max	Min	Max
A	3.81	5.08	0.105	0.200
A ₁	0.38	1.27	0.015	0.050
A ₂	1.27	2.03	0.050	0.080
b	0.89	1.65	0.035	0.065
b ₁	0.38	0.51	0.015	0.020
c	0.20	0.30	0.008	0.012
D-8	9.40	11.68	0.370	0.460
E	5.59	7.11	0.220	0.280
E ₁	7.62	8.26	0.300	0.325
e	2.29	2.79	0.090	0.110
e ₁	7.37	7.87	0.290	0.310
L	2.79	3.81	0.110	0.150
S-8	1.02	2.03	0.040	0.080
∅	0°	15°	0°	15°

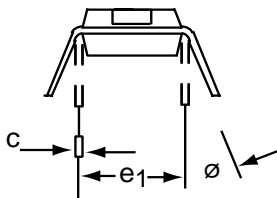

CERDIP-8 PACKAGE DRAWING

8 Pin CERDIP Package

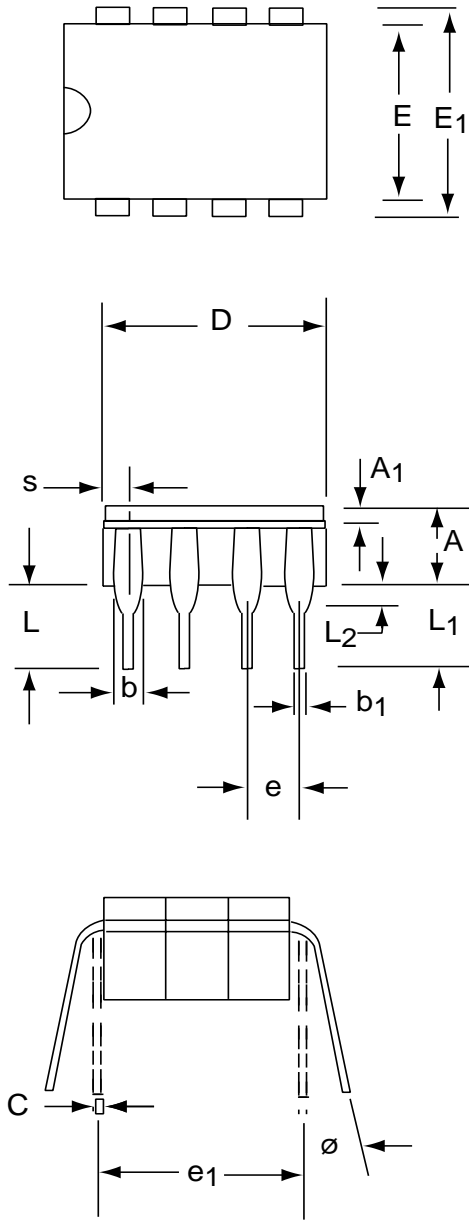

Dim	Millimeters		Inches	
	Min	Max	Min	Max
A	3.55	5.08	0.140	0.200
A ₁	1.27	2.16	0.050	0.085
b	0.97	1.65	0.038	0.065
b ₁	0.36	0.58	0.014	0.023
C	0.20	0.38	0.008	0.015
D-8	--	10.29	--	0.405
E	5.59	7.87	0.220	0.310
E ₁	7.73	8.26	0.290	0.325
e	2.54 BSC		0.100 BSC	
e ₁	7.62 BSC		0.300 BSC	
L	3.81	5.08	0.150	0.200
L ₁	3.18	--	0.125	--
L ₂	0.38	1.78	0.015	0.070
S	--	2.49	--	0.098
∅	0°	15°	0°	15°