



PRECISION ULTRA MICROPPOWER CMOS OPERATIONAL AMPLIFIER

GENERAL DESCRIPTION

The ALD1736A/ALD1736 is a precision low-cost ultra micropower high slew-rate high performance monolithic CMOS operational amplifier intended for a broad range of analog applications using $\pm 1V$ to $\pm 5V$ dual power supply systems, as well as $+2V$ to $+10V$ battery operated systems. All device characteristics are specified for $+5V$ single supply or $\pm 2.5V$ dual supply systems. Typical supply current is $20\mu A$ at $5V$ supply voltage. It is manufactured with Advanced Linear Devices' enhanced EPAD[®] silicon gate CMOS process.

The ALD1736A/ALD1736 is designed to offer high performance for a wide range of applications requiring very low power dissipation. It has been developed specifically for the $+5V$ single battery or $\pm 1V$ to $\pm 5V$ dual battery user and offers the popular industry standard single operational amplifier pin configuration.

Several important characteristics of the device make application easier to implement at those voltages. First, the operational amplifier can operate with rail to rail input and output voltages. This means the signal input voltage and output voltage can be close to or equal to the positive and negative supply voltages. This feature allows numerous analog serial stages and flexibility in input signal bias levels. Second, the device was designed to accommodate mixed applications where digital and analog circuits may operate off the same power supply or battery. Third, the output stage can typically drive up to $25pF$ capacitive and $20K\Omega$ resistive loads.

These features, combined with extremely low input currents, high open loop voltage gain of $100V/mV$, useful bandwidth of $400KHz$, a slew rate of $0.17V/\mu s$, low offset voltage and temperature drift, make the ALD1736A/ALD1736 a versatile, ultra micropower operational amplifier.

The ALD1736A/ALD1736, designed and fabricated with silicon gate CMOS technology, offers on-chip offset voltage trimming, allowing the device to be used without nulling in most applications. It is also designed to offer tolerance to over-voltage input spikes of $300mV$ beyond supply rails, high open loop voltage gain, and robust operation at temperature extremes. Additionally, robust design and rigorous screening make this device especially suitable for operation in temperature-extreme environments and rugged conditions.

ORDERING INFORMATION ("L" suffix denotes lead-free (RoHS))

| Operating Temperature Range | | |
|--|---------------------------------|-----------------------------------|
| $0^{\circ}C$ to $+70^{\circ}C$ | $0^{\circ}C$ to $+70^{\circ}C$ | $-55^{\circ}C$ to $+125^{\circ}C$ |
| 8-Pin Small Outline Package (SOIC) | 8-Pin Plastic Dip Package | 8-Pin CERDIP Package |
| ALD1736ASAL | ALD1736APAL | |
| ALD1736SAL | ALD1736PAL | |
| ALD1736ASA | | ALD1736ADA |
| ALD1736SA | | ALD1736DA |

* Contact factory for leaded (non-RoHS) or high temperature versions.

FEATURES & BENEFITS

- $20\mu A$ supply current
- All parameters specified for $+5V$ single supply or $\pm 2.5V$ dual supply systems
- Rail to rail input and output voltage ranges
- No frequency compensation required -- unity gain stable
- Extremely low input bias currents -- $0.01pA$ typical
- Ideal for high source impedance applications
- Dual power supplies $\pm 1.0V$ to $\pm 5.0V$
- Single power supply $+2.0V$ to $+10.0V$
- High voltage gain -- typically $100V/mV$ @ $\pm 2.5V$ ($100dB$)
- Drive as low as a $20K\Omega$ load
- Output short circuit protected
- Unity gain bandwidth of $0.4MHz$
- Slew rate of $0.17V/\mu s$
- Ultra Micropower dissipation
- Suitable for rugged, temperature-extreme environments

APPLICATIONS

- Voltage amplifier
- Voltage follower/buffer
- Charge integrator
- Photodiode amplifier
- Data acquisition systems
- High performance portable instruments
- Biochemical probe interface
- Signal conditioning circuits
- Sensor and transducer amplifiers
- Low leakage amplifiers
- Precision Sample and Hold amplifiers
- Active filters
- Picoammeter
- Current to voltage converter

PIN CONFIGURATION

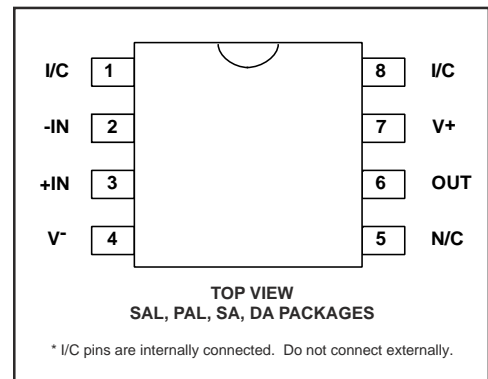

ABSOLUTE MAXIMUM RATINGS

Supply voltage, V+ _____ 10.6V
 Differential input voltage range _____ -0.3V to V+ +0.3V
 Power dissipation _____ 600mW
 Operating temperature range SAL, PAL, SA packages _____ 0°C to +70°C
 DA package _____ -55°C to +125°C
 Storage temperature range _____ -65°C to +150°C
 Lead temperature, 10 seconds _____ +260°C

CAUTION: ESD Sensitive Device. Use static control procedures in ESD controlled environment.

OPERATING ELECTRICAL CHARACTERISTICS

T_A = 25°C V_S = ±2.5V unless otherwise specified

| Parameter | Symbol | ALD1736A | | | ALD1736 | | | Unit | Test Conditions |
|------------------------------|---------------------|----------|------------------|-----------|---------|------------------|-----------|----------|--|
| | | Min | Typ | Max | Min | Typ | Max | | |
| Supply Voltage | V _S | ±1.0 | | ±5.0 | ±1.0 | | ±5.0 | V | Dual Supply Single Supply |
| | V+ | 2.0 | | 10.0 | 2.0 | | 10.0 | V | |
| Input Offset Voltage | V _{OS} | | | 0.15 | | | 0.4 | mV | R _S ≤ 100KΩ 0°C ≤ T _A ≤ +70°C |
| | | | | 0.8 | | | 1.5 | mV | |
| Input Offset Current | I _{OS} | | 0.01 | 10 240 | | 0.01 | 10 240 | pA pA | T _A = 25°C 0°C ≤ T _A ≤ +70°C |
| Input Bias Current | I _B | | 0.01 | 10 300 | | 0.01 | 10 300 | pA pA | T _A = 25°C 0°C ≤ T _A ≤ +70°C |
| Input Voltage Range | V _{IR} | -0.3 | | +5.3 | -0.3 | | +5.3 | V | V+ = +5V V _S = ±2.5V |
| | | -2.8 | | +2.8 | -2.8 | | +2.8 | V | |
| Input Resistance | R _{IN} | | 10 ¹⁴ | | | 10 ¹⁴ | | Ω | |
| Input Offset Voltage Drift | TCV _{OS} | | 5 | | | 5 | | μV/°C | R _S ≤ 100KΩ |
| Power Supply Rejection Ratio | PSRR | | 80 | | | 80 | | dB | R _S ≤ 100KΩ 0°C ≤ T _A ≤ +70°C |
| | | | 80 | | | 80 | | dB | |
| Common Mode Rejection Ratio | CMRR | | 83 | | | 83 | | dB | R _S ≤ 100KΩ 0°C ≤ T _A ≤ +70°C |
| | | | 83 | | | 83 | | dB | |
| Large Signal Voltage Gain | A _V | | 100 | | | 100 | | V/mV | R _L = 1MΩ |
| Output Voltage Range | V _O low | | 0.001 | 0.01 | | 0.001 | 0.01 | V | R _L = 1MΩ 0°C ≤ T _A ≤ +70°C |
| | V _O high | 4.99 | 4.999 | | 4.99 | 4.999 | | V | |
| | V _O low | | -2.48 | -2.40 | | -2.48 | -2.40 | V | |
| | V _O high | 2.40 | 2.48 | | 2.40 | 2.40 | | V | |
| Output Short Circuit Current | I _{SC} | | 200 | | | 200 | | μA | |
| Supply Current | I _S | | 20 | 40 | | 20 | 50 | μA | V _{IN} = 0V, No Load |
| Power Dissipation | P _D | | | 200 | | | 250 | μW | V _S = ±2.5V |
| Input Capacitance | C _{IN} | | 1 | | | 1 | | pF | |
| Bandwidth | BW | | 400 | | | 400 | | KHz | |
| Slew Rate | SR | | .17 | | | .17 | | V/μs | A _V = +1, R _L = 1MΩ |

OPERATING ELECTRICAL CHARACTERISTICS (cont'd)

$T_A = 25^\circ\text{C}$ $V_S = \pm 2.5\text{V}$ unless otherwise specified (cont'd)

| Parameter | Symbol | ALD1736A | | | ALD1736 | | | Unit | Test Conditions |
|------------------|--------|----------|------|-----|---------|------|-----|---------------|--|
| | | Min | Typ | Max | Min | Typ | Max | | |
| Rise time | t_r | | 1.0 | | | 1.0 | | μs | $R_L = 1\text{M}\Omega$ |
| Overshoot Factor | | | 20 | | | 20 | | % | $R_L = 1\text{M}\Omega$, $C_L = 25\text{pF}$ |
| Settling Time | t_s | | 10.0 | | | 10.0 | | μs | 0.1%, $A_V = -1$, $R_L = 1\text{M}\Omega$ $C_L = 25\text{pF}$ |

$T_A = 25^\circ\text{C}$ $V_S = \pm 1.0\text{V}$ unless otherwise specified

| Parameter | Symbol | ALD1736A | | | ALD1736 | | | Unit | Test Conditions |
|------------------------------|---|----------|---------------|------|---------|---------------|------|------------------|----------------------------------|
| | | Min | Typ | Max | Min | Typ | Max | | |
| Power Supply Rejection Ratio | PSRR | | 70 | | | 70 | | dB | $R_S \leq 1\text{M}\Omega$ |
| Common Mode Rejection Ratio | CMRR | | 70 | | | 70 | | dB | $R_S \leq 1\text{M}\Omega$ |
| Large Signal Voltage Gain | A_V | | 50 | | | 50 | | V/mV | $R_L = 1\text{M}\Omega$ |
| Output Voltage Range | $V_{O\text{ low}}$ $V_{O\text{ high}}$ | 0.9 | -0.95 0.95 | -0.9 | 0.9 | -0.95 0.95 | -0.9 | V | $R_L = 1\text{M}\Omega$ |
| Bandwidth | B_W | | 0.3 | | | 0.3 | | MHz | |
| Slew Rate | S_R | | 0.17 | | | 0.17 | | V/ μs | $A_V = +1$, $C_L = 50\text{pF}$ |

$V_S = \pm 2.5\text{V}$ $-55^\circ\text{C} \leq T_A \leq +125^\circ\text{C}$ unless otherwise specified

| Parameter | Symbol | ALD1736A | | | ALD1736 | | | Unit | Test Conditions |
|------------------------------|---|----------|---------------|-------|---------|---------------|-------|--------|------------------------------|
| | | Min | Typ | Max | Min | Typ | Max | | |
| Input Offset Voltage | VOS | | | 2.0 | | | 3.0 | mV | $R_S \leq 100\text{K}\Omega$ |
| Input Offset Current | I _{OS} | | | 2.0 | | | 2.0 | nA | |
| Input Bias Current | I _B | | | 2.0 | | | 2.0 | nA | |
| Power Supply Rejection Ratio | PSRR | | 75 | | | 75 | | dB | $R_S \leq 1\text{M}\Omega$ |
| Common Mode Rejection Ratio | CMRR | | 83 | | | 83 | | dB | $R_S \leq 1\text{M}\Omega$ |
| Large Signal Voltage Gain | A_V | | 50 | | | 50 | | V/mV | $R_L = 1\text{M}\Omega$ |
| Output Voltage Range | $V_{O\text{ low}}$ $V_{O\text{ high}}$ | 2.30 | -2.40 2.40 | -2.30 | 2.30 | -2.40 2.40 | -2.30 | V V | $R_L = 1\text{M}\Omega$ |

Design & Operating Notes:

1. The ALD1736A/ALD1736 CMOS operational amplifier uses a 3 gain stage architecture and an improved frequency compensation scheme to achieve large voltage gain, high output driving capability, and better frequency stability. In a conventional CMOS operational amplifier design, compensation is achieved with a pole splitting capacitor together with a nulling resistor. This method is, however, very bias dependent and thus cannot accommodate the large range of supply voltage operation as is required from a stand alone CMOS operational amplifier. The ALD1736A/ALD1736 is internally compensated for unity gain stability using a novel scheme that does not use a nulling resistor. This scheme produces a clean single pole roll off in the gain characteristics while providing for more than 70 degrees of phase margin at the unity gain frequency.
2. The ALD1736A/ALD1736 has complementary p-channel and n-channel input differential stages connected in parallel to accomplish rail to rail common mode input voltage ranges. This means that with the ranges of common mode input voltage close to the power supplies, one of the two differential stages is switched off internally. To maintain compatibility with other operational amplifiers, this switching point has been selected to be about 1.5V below the positive supply voltage. Since offset voltage trimming on the ALD1736A/ALD1736 is made when the input voltage is symmetrical to the supply voltages, this internal switching does not affect a large variety of applications such as an inverting amplifier or non-inverting amplifier with a gain larger than 2.5 (5V operation), where the common mode voltage does not make excursions below this switching point. The user should, however, be aware that this switching does take place if the operational amplifier is connected as a unity gain buffer and should make provisions in the design to allow for input offset voltage variations.
3. The input bias and offset currents are essentially input protection diode reverse bias leakage currents, and are typically 0.01 pA at room temperature. This low input bias current assures that the analog signal from the source will not be distorted by input bias currents.

Normally, this extremely high input impedance of greater than $10^{14}\Omega$ would not be a problem as the source impedance would limit the node impedance. However, for applications where source impedance is very high, it may be necessary to limit noise and hum pickup through proper shielding.

4. The output stage consists of class AB complementary output drivers, capable of driving a low resistance load. The output voltage swing is limited by the drain to source on-resistance of the output transistors as determined by the bias circuitry, and the value of the load resistor. When connected in the voltage follower configuration, the oscillation resistant feature, combined with the rail to rail input and output feature, makes an effective analog signal buffer for medium to high source impedance sensors, transducers, and other circuit networks.
5. The ALD1736A/ALD1736 operational amplifier has been designed to provide full static discharge protection. Internally, the design has been carefully implemented to minimize latch up. However, care must be exercised when handling the device to avoid strong static fields that may degrade a diode junction, causing increased input leakage currents. In using the operational amplifier, the user is advised to power up the circuit before, or simultaneously with, any input voltages applied and to limit input voltages to not exceed 0.3V of the power supply voltage levels.
6. The ALD1736A/ALD1736, with its ultra micropower operation, offers numerous benefits in reduced power supply requirements, less noise coupling and current spikes, less thermally induced drift, better overall reliability due to lower self heating, and lower input bias current. It requires practically no warm up time as the chip junction heats up to less than 0.1°C above ambient temperature under most operating conditions.
7. The ALD1736A/ALD1736 has an internal design architecture that provides robust high temperature operation. Contact factory for custom screening versions.

TYPICAL PERFORMANCE CHARACTERISTICS

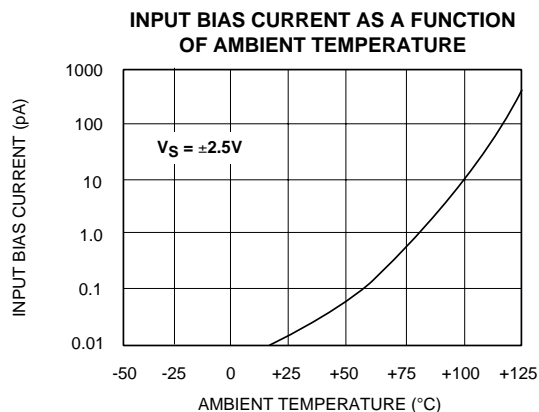
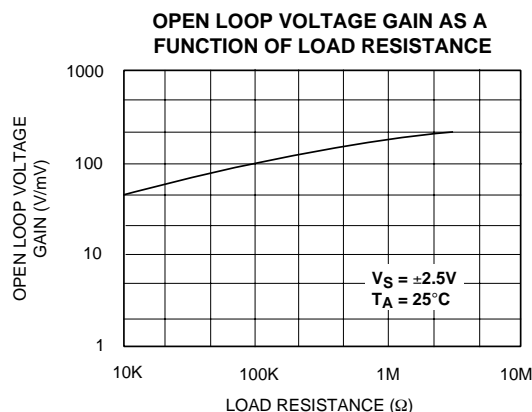
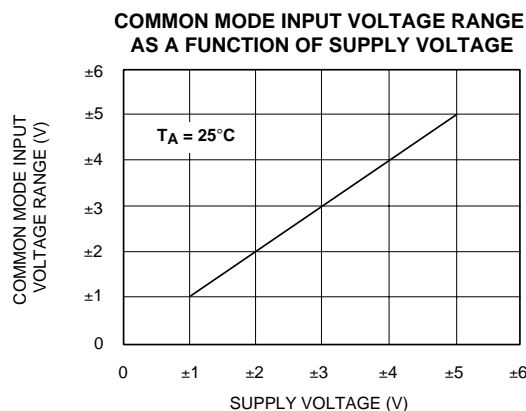
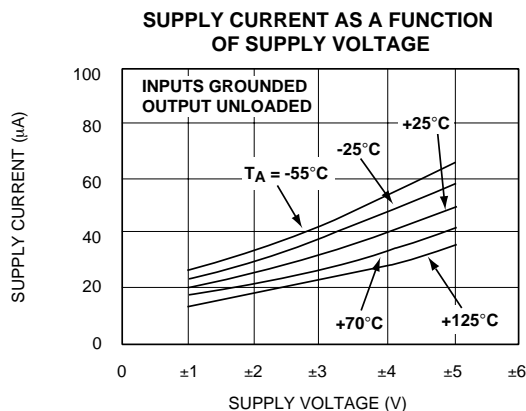

TYPICAL PERFORMANCE CHARACTERISTICS (cont'd)

OPEN LOOP VOLTAGE GAIN AS A FUNCTION OF SUPPLY VOLTAGE AND TEMPERATURE

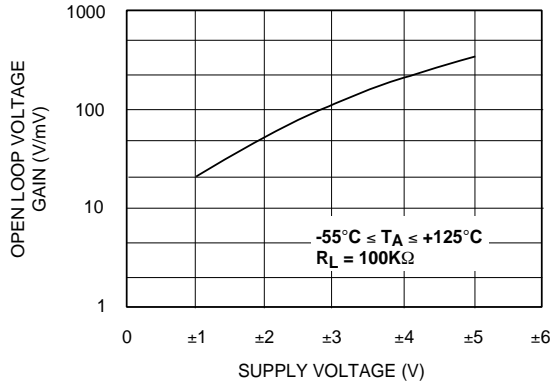

OUTPUT VOLTAGE SWING AS A FUNCTION OF SUPPLY VOLTAGE

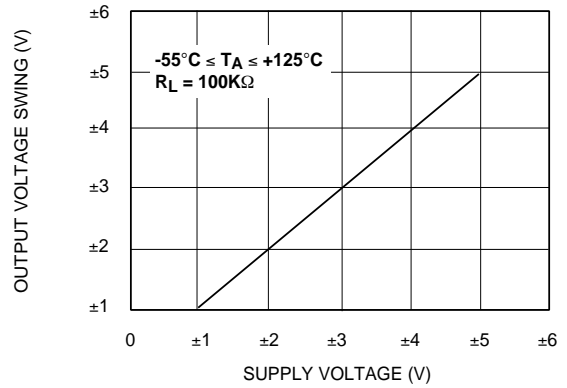

OPEN LOOP VOLTAGE GAIN AS A FUNCTION OF FREQUENCY

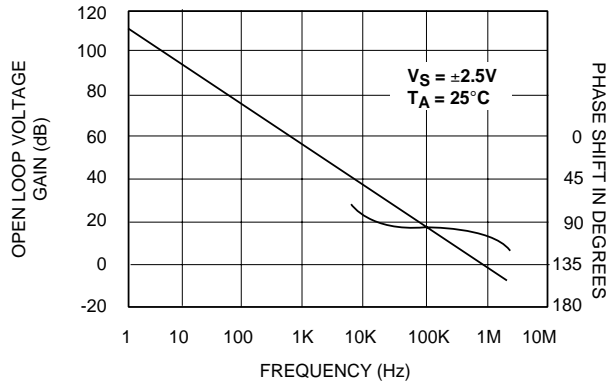

LARGE-SIGNAL TRANSIENT RESPONSE

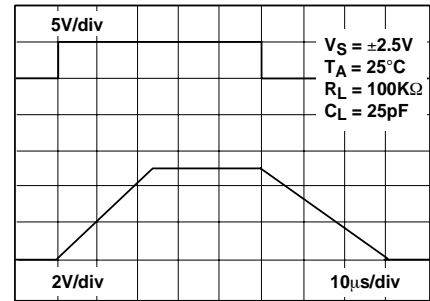

LARGE-SIGNAL TRANSIENT RESPONSE

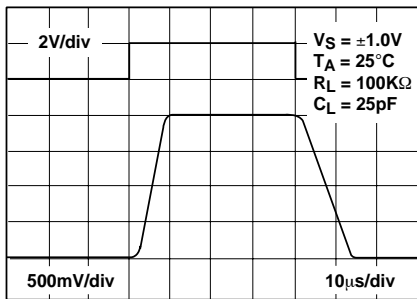

SMALL-SIGNAL TRANSIENT RESPONSE

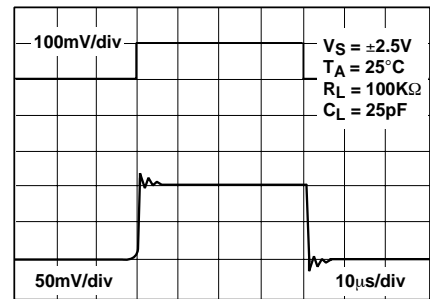

TYPICAL APPLICATIONS

RAIL-TO-RAIL VOLTAGE FOLLOWER/BUFFER

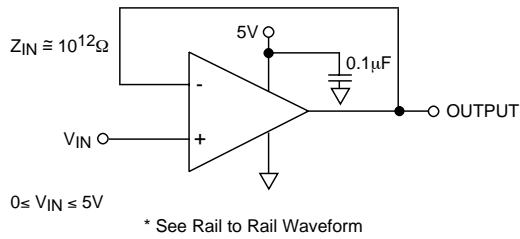

CHARGE INTEGRATOR

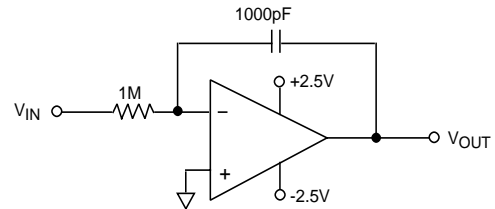

HIGH INPUT IMPEDANCE RAIL-TO-RAIL PRECISION DC SUMMING AMPLIFIER

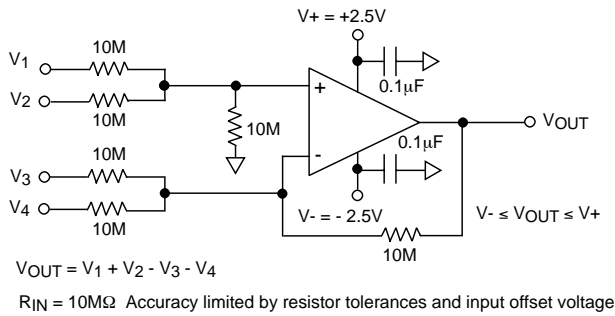

RAIL-TO-RAIL VOLTAGE COMPARATOR

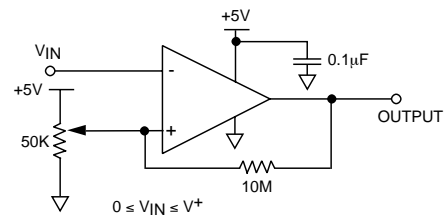

HIGH IMPEDANCE NON-INVERTING AMPLIFIER

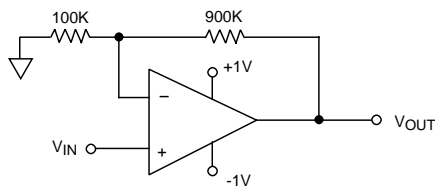
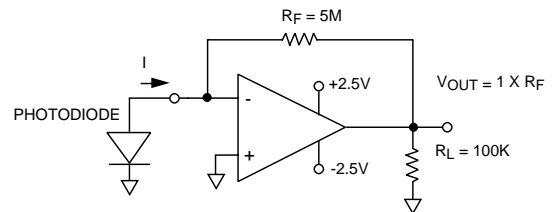
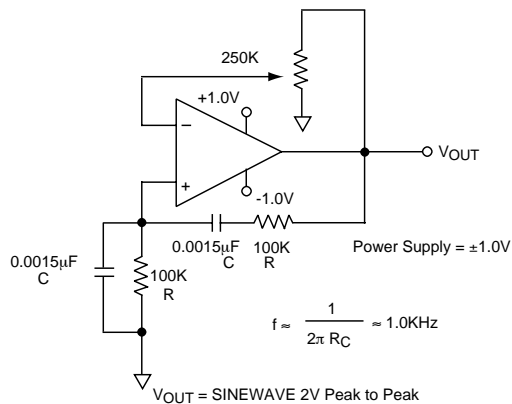

PHOTO DETECTOR CURRENT TO VOLTAGE CONVERTER



WIEN BRIDGE OSCILLATOR



MICROPOWER BUFFERED VARIABLE VOLTAGE SOURCE

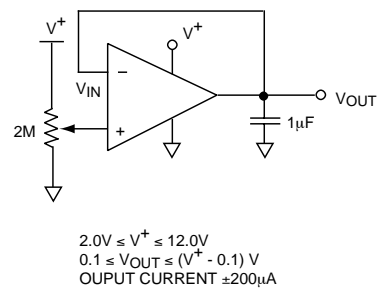

SOIC-8 PACKAGE DRAWING

8 Pin Plastic SOIC Package

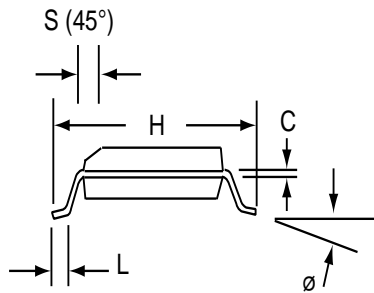
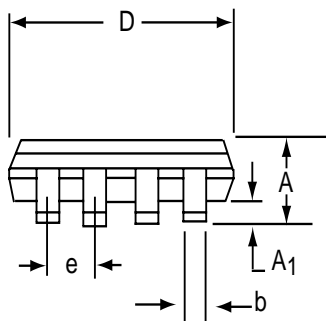
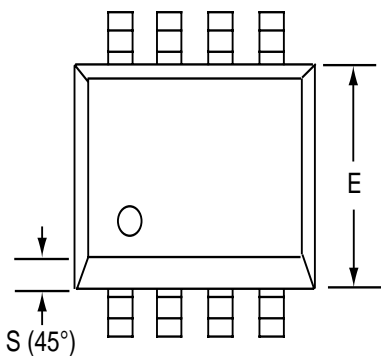

| Dim | Millimeters | | Inches | |
|----------------|-------------|-------|-----------|-------|
| | Min | Max | Min | Max |
| A | 1.35 | 1.75 | 0.053 | 0.069 |
| A ₁ | 0.10 | 0.25 | 0.004 | 0.010 |
| b | 0.35 | 0.45 | 0.014 | 0.018 |
| C | 0.18 | 0.25 | 0.007 | 0.010 |
| D-8 | 4.69 | 5.00 | 0.185 | 0.196 |
| E | 3.50 | 4.05 | 0.140 | 0.160 |
| e | 1.27 BSC | | 0.050 BSC | |
| H | 5.70 | 6.30 | 0.224 | 0.248 |
| L | 0.60 | 0.937 | 0.024 | 0.037 |
| ∅ | 0° | 8° | 0° | 8° |
| S | 0.25 | 0.50 | 0.010 | 0.020 |

PDIP-8 PACKAGE DRAWING

8 Pin Plastic DIP Package

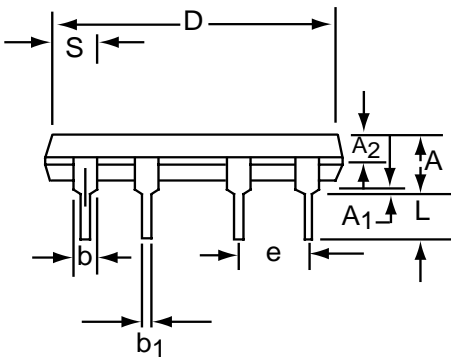
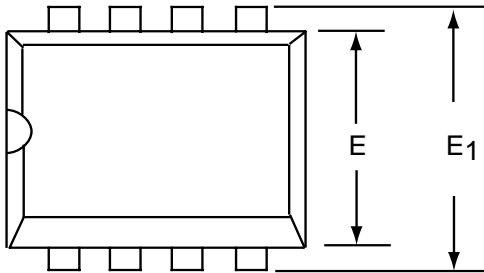

| Dim | Millimeters | | Inches | |
|----------------|-------------|-------|--------|-------|
| | Min | Max | Min | Max |
| A | 3.81 | 5.08 | 0.105 | 0.200 |
| A ₁ | 0.38 | 1.27 | 0.015 | 0.050 |
| A ₂ | 1.27 | 2.03 | 0.050 | 0.080 |
| b | 0.89 | 1.65 | 0.035 | 0.065 |
| b ₁ | 0.38 | 0.51 | 0.015 | 0.020 |
| c | 0.20 | 0.30 | 0.008 | 0.012 |
| D-8 | 9.40 | 11.68 | 0.370 | 0.460 |
| E | 5.59 | 7.11 | 0.220 | 0.280 |
| E ₁ | 7.62 | 8.26 | 0.300 | 0.325 |
| e | 2.29 | 2.79 | 0.090 | 0.110 |
| e ₁ | 7.37 | 7.87 | 0.290 | 0.310 |
| L | 2.79 | 3.81 | 0.110 | 0.150 |
| S-8 | 1.02 | 2.03 | 0.040 | 0.080 |
| ∅ | 0° | 15° | 0° | 15° |

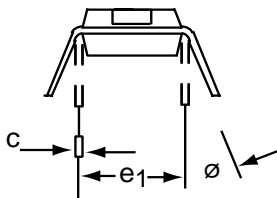

CERDIP-8 PACKAGE DRAWING

8 Pin CERDIP Package

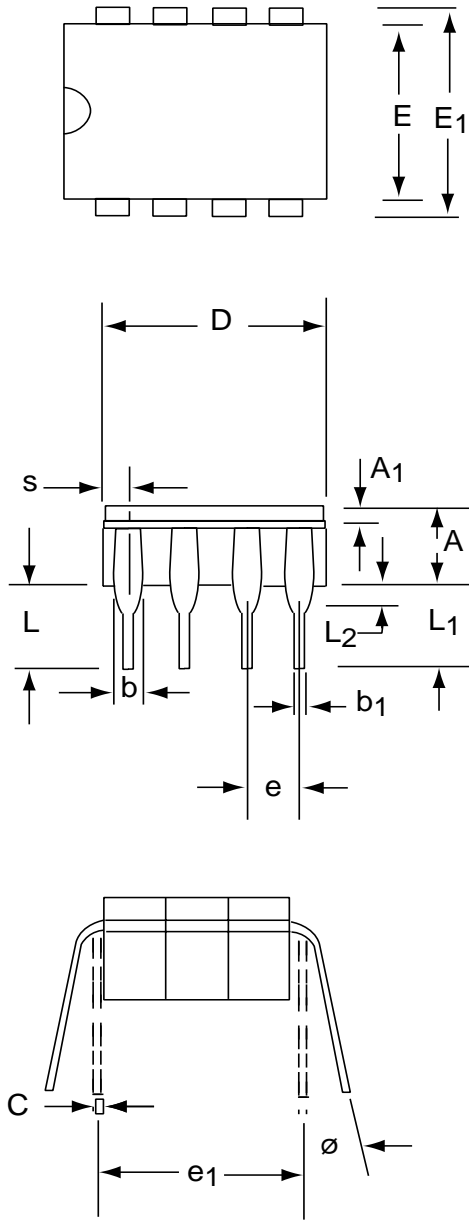

| Dim | Millimeters | | Inches | |
|----------------|-------------|-------|-----------|-------|
| | Min | Max | Min | Max |
| A | 3.55 | 5.08 | 0.140 | 0.200 |
| A ₁ | 1.27 | 2.16 | 0.050 | 0.085 |
| b | 0.97 | 1.65 | 0.038 | 0.065 |
| b ₁ | 0.36 | 0.58 | 0.014 | 0.023 |
| C | 0.20 | 0.38 | 0.008 | 0.015 |
| D-8 | -- | 10.29 | -- | 0.405 |
| E | 5.59 | 7.87 | 0.220 | 0.310 |
| E ₁ | 7.73 | 8.26 | 0.290 | 0.325 |
| e | 2.54 BSC | | 0.100 BSC | |
| e ₁ | 7.62 BSC | | 0.300 BSC | |
| L | 3.81 | 5.08 | 0.150 | 0.200 |
| L ₁ | 3.18 | -- | 0.125 | -- |
| L ₂ | 0.38 | 1.78 | 0.015 | 0.070 |
| S | -- | 2.49 | -- | 0.098 |
| ∅ | 0° | 15° | 0° | 15° |