

10 9 8 7 6 5 4 3 2 1

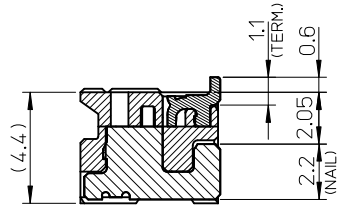

SECTION Z-Z

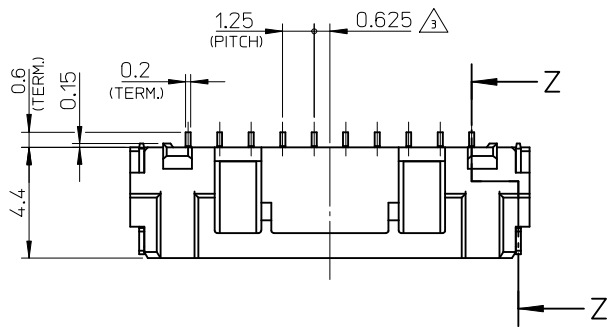
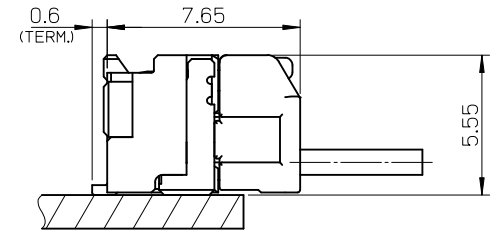
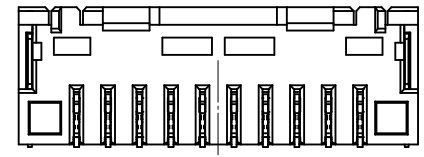
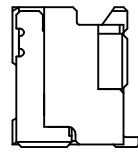
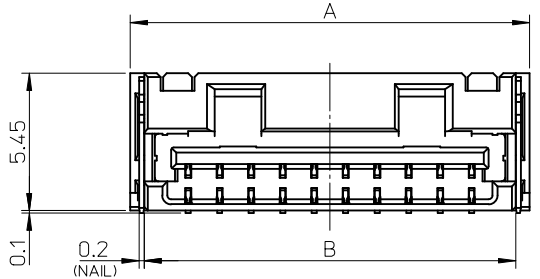
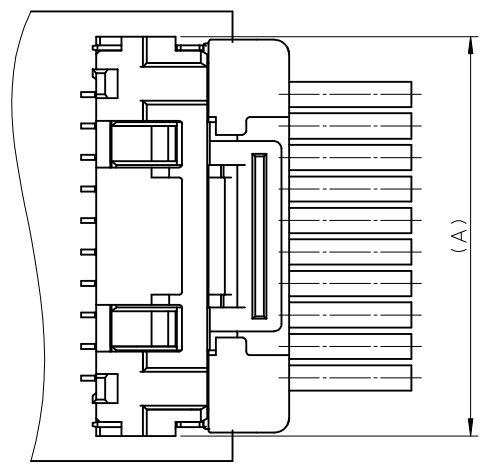

嵌合部
MATED CONNECTORS

NOTES

1. 嵌合相手: 502380-****
MATE WITH : 502380-****
2. 端子テール部 及び ネイルの平坦度: 0.1MAX.
TAIL AND NAIL COPLANARITY TO BE 0.1 MAX.
3. 極数/2=偶数に適用。
APPLY FOR CKT. SIZE / 2 = EVEN.
4. 端子テール部 及び ネイルに錫めっきを使用しているため、
外観に摺動痕が付く場合が御座います。
THE WOUND OF FRICTION MIGHT ADHERE TO EXTERNALS
BECAUSE THE TIN PLATING IS USED FOR THE TAIL AND NAIL.
5. 本製品のプラスチック部に黒点等が確認される場合や
色合いが異なる場合がありますが、製品性能に影響はありません。
THERE IS NO INFLUENCE IN THE PRODUCT PERFORMANCE THOUGH
THE BLACK SPOT ETC. MIGHT BE CONFIRMED TO THE PLASTIC PART
OF THIS PRODUCT AND THE SHADE MIGHT BE DIFFERENT.

| | | | | | | | |
|-----|------|-------|-------|-------|-------|---|----------------|
| 2 | 10.7 | 11.5 | 17.5 | 21 | 22.1 | 502386-15** | 15 |
| 2 | 9.45 | 10.25 | 16.25 | 19.75 | 20.85 | 502386-14** | 14 |
| 2 | 8.2 | 9 | 15 | 18.5 | 19.6 | 502386-13** | 13 |
| 2 | 6.95 | 7.75 | 13.75 | 17.25 | 18.35 | 502386-12** | 12 |
| 2 | 5.7 | 6.5 | 12.5 | 16 | 17.1 | 502386-11** | 11 |
| 2 | 4.45 | 5.25 | 11.25 | 14.75 | 15.85 | 502386-10** | 10 |
| 2 | 3.2 | 4 | 10 | 13.5 | 14.6 | 502386-09** | 9 |
| 2.6 | 1.95 | 2.75 | 8.75 | 12.25 | 13.35 | 502386-08** | 8 |
| F | E | D | C | B | A | EMBOSSED TAPE PACKAGE オーダー番号 ORDER No. | 極数 CKT. NO. |

| 番号 NO. | 部品 PART | 材質 MATERIAL |
|-----------|-------------------|--|
| ① | ハウジング HOUSING | 耐熱性樹脂 UL94V-0 色:SHEET 3 参照 HEATPROOF RESIN UL94V-0 COLOR : SEE SHEET 3 |
| ② | ターミナル TERMINAL | 銅合金 COPPER ALLOY 錫めっき : 1.0 micro-meter MIN. TIN (TAIL AREA) ニッケルめっき(下地): 1.0 micro-meter MIN. NICKEL (UNDER PLATING) |
| ③ | ネイル NAIL | 銅合金 COPPER ALLOY 錫めっき: 1.0 micro-meter MIN. TIN ニッケルめっき(下地): 1.0 micro-meter MIN. NICKEL (UNDER PLATING) |

| | | | | | | | | | |
|--|--------------|--|-------|----------------------------|-------------------------------|--|------------------------|---------------------------|--|
| REVISED EC NO.: J2013-0870 DRWN: KWASHIO 2013/02/07 CHKD: KASAKAWA 2013/02/13 APPR: Y01TO 2013/02/13 | DESCRIPTION | GENERAL TOLERANCES (UNLESS SPECIFIED) | | DIMENSION STYLE MM ONLY | | SCALE 5:1 | DESIGN UNITS METRIC | THIRD ANGLE PROJECTION | |
| | | 10 UNDER | ±0.2 | DRAWN BY T. MIYAZAKI | DATE 2006/08/28 | TITLE 1.25 W/B CONN. SINGLE R/A REC. ASS'Y 8-15CKT. -LEAD FREE- | | | |
| | | 10 OVER 30 UNDER | ±0.25 | CHECKED BY K. ASAKAWA | DATE 2006/08/28 | | | | |
| | | 30 OVER | ±0.3 | APPROVED BY Y0. ITO | DATE 2006/08/28 | | | | |
| REV | ANGULAR ±3 ° | DRAFT WHERE APPLICABLE MUST REMAIN WITHIN DIMENSIONS | | MATERIAL NO. SEE TABLE | DOCUMENT NO. SD-502386-002 | SHEET NO. 1 OF 3 | | | |
| SIZE A3 | | THIS DRAWING CONTAINS INFORMATION THAT IS PROPRIETARY TO MOLEX INCORPORATED AND SHOULD NOT BE USED WITHOUT WRITTEN PERMISSION | | | | | | | |

9 8 7 6 5 4 3 2

10 9 8 7 6 5 4 3 2 1

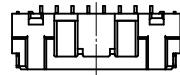

8 CKT.

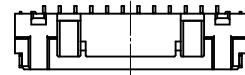

12 CKT.

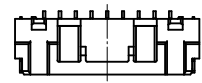

9 CKT.

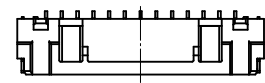

13 CKT.

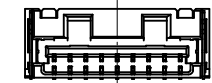

10 CKT.

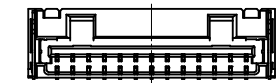

14 CKT.

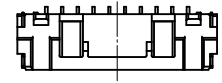

11 CKT.

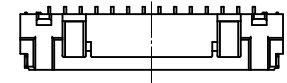

15 CKT.

極数の種類

KIND OF CKT. NO. (FRONT VIEW)

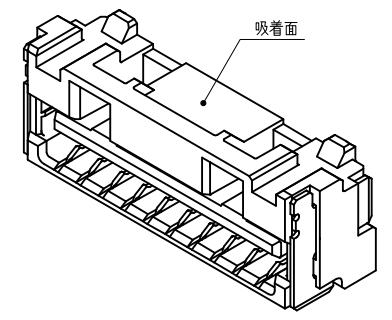
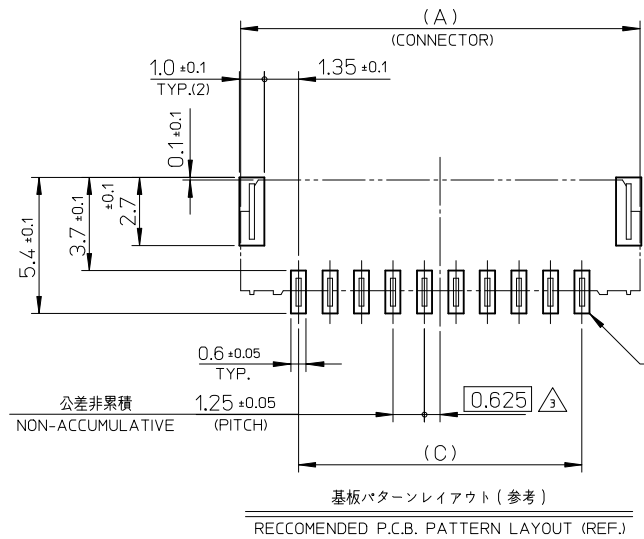
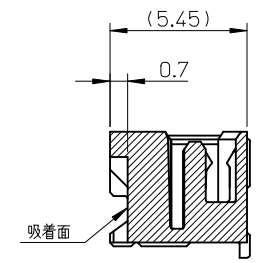
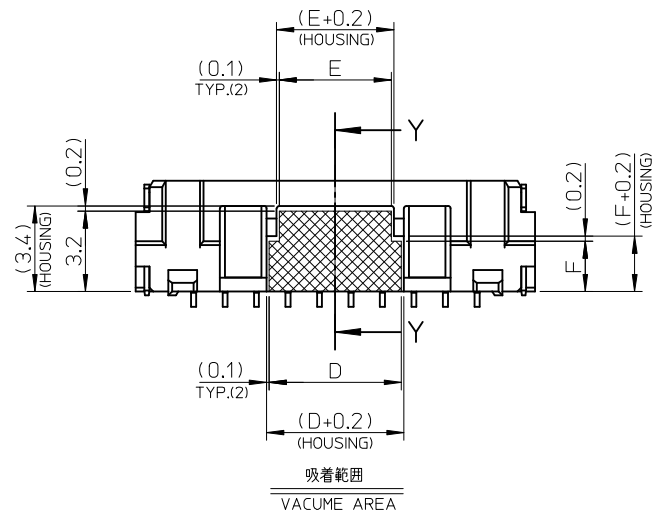

| | | | | | | |
|---|---------------------------------------|---------------------------|---|-------------------------------|--|------------------------|
| REVISED EC NO.: J2013-0870 DRWN:KASHIO 2013/02/07 CHKD:KASAKAWA 2013/02/13 APPR:Y0 ITO 2013/02/13 | GENERAL TOLERANCES (UNLESS SPECIFIED) | | DIMENSION STYLE MM ONLY | SCALE 5:1 | DESIGN UNITS METRIC | THIRD ANGLE PROJECTION |
| | 10 UNDER | ±0.2 | DRAWN BY T. MIYAZAKI | DATE 2006/08/28 | TITLE 1.25 W/B CONN. SINGLE R/A REC. ASS'Y 8-15CKT. -LEAD FREE- | |
| | 10 OVER 30 UNDER | ±0.25 | CHECKED BY K. ASAKAWA | DATE 2006/08/28 | | |
| | 30 OVER | ±0.3 | APPROVED BY Y0. ITO | DATE 2006/08/28 | | |
| ANGULAR | ±3 ° | MATERIAL NO. SEE TABLE | | DOCUMENT NO. SD-502386-002 | SHEET NO. 2 OF 3 | |
| DRAFT WHERE APPLICABLE MUST REMAIN WITHIN DIMENSIONS | | SIZE A3 | THIS DRAWING CONTAINS INFORMATION THAT IS PROPRIETARY TO MOLEX INCORPORATED AND SHOULD NOT BE USED WITHOUT WRITTEN PERMISSION | | | |

9 8 7 6 5 4 3 2

| | | |
|--|------------------------------|----------------|
| HSG COLOR : ORANGE | | |
| -- | 502386-**28 | 15 |
| -- | | 14 |
| -- | | 13 |
| -- | | 12 |
| -- | | 11 |
| -- | | 10 |
| 502386-0948 | | 9 |
| -- | | 8 |
| EMBOSSED TAPE PACKAGE オーダー番号ORDER No. | コネクタ シリズ CONNECTOR SERIES | 極数 Ckt. No. |

| HSG COLOR : GREEN | | HSG COLOR : BLUE | | HSG COLOR : YELLOW | | HSG COLOR : RED | | HSG COLOR : BLACK | | HSG COLOR : NATURAL | | |
|--|------------------------------|--|------------------------------|--|------------------------------|--|------------------------------|--|------------------------------|--|------------------------------|----------------|
| 502386-1546 | 502386-**26 | 502386-1544 | 502386-**24 | -- | 502386-**23 | 502386-1542 | 502386-**22 | 502386-1541 | 502386-**21 | 502386-1570 | 502386-**09 | |
| 502386-1446 | | 502386-1444 | | -- | | 502386-1442 | | 502386-1441 | | 502386-1470 | | |
| 502386-1346 | | 502386-1344 | | -- | | 502386-1342 | | 502386-1341 | | 502386-1370 | | |
| 502386-1246 | | 502386-1244 | | -- | | 502386-1242 | | 502386-1241 | | 502386-1270 | | |
| 502386-1146 | | 502386-1144 | | -- | | 502386-1142 | | 502386-1141 | | 502386-1170 | | |
| 502386-1046 | | 502386-1044 | | -- | | 502386-1042 | | 502386-1041 | | 502386-1070 | | |
| 502386-0946 | | 502386-0944 | | 502386-0943 | | 502386-0942 | | 502386-0941 | | 502386-0970 | | |
| 502386-0846 | | 502386-0844 | | -- | | 502386-0842 | | 502386-0841 | | 502386-0870 | | |
| EMBOSSED TAPE PACKAGE オーダー番号ORDER No. | コネクタ シリズ CONNECTOR SERIES | EMBOSSED TAPE PACKAGE オーダー番号ORDER No. | コネクタ シリズ CONNECTOR SERIES | EMBOSSED TAPE PACKAGE オーダー番号ORDER No. | コネクタ シリズ CONNECTOR SERIES | EMBOSSED TAPE PACKAGE オーダー番号ORDER No. | コネクタ シリズ CONNECTOR SERIES | EMBOSSED TAPE PACKAGE オーダー番号ORDER No. | コネクタ シリズ CONNECTOR SERIES | EMBOSSED TAPE PACKAGE オーダー番号ORDER No. | コネクタ シリズ CONNECTOR SERIES | 極数 Ckt. No. |

| | | | | | | |
|---|--------------|--|--|--|--|---------------------------|
| REVISED EC NO. J2013-0870 DRWN:KASHIO 2013/02/07 CHKD:KASAKAWA 2013/02/13 APPR:Y.ITO 2013/02/13 | DESCRIPTION | GENERAL TOLERANCES (UNLESS SPECIFIED) | DIMENSION STYLE MM ONLY | SCALE ---- | DESIGN UNITS METRIC | THIRD ANGLE PROJECTION |
| | REV | 10 UNDER ±0.2 | DRAWN BY DATE T. MIYAZAKI 2006/08/28 | TITLE 1.25 W/B CONN. SINGLE R/A REC. ASS'Y 8-15CKT. -LEAD FREE- | | |
| | | 10 OVER 30 UNDER ±0.25 | CHECKED BY DATE K. ASAKAWA 2006/08/28 | APPROVED BY DATE Y.O. ITO 2006/08/28 | molex DOCUMENT NO. SD-502386-002 SHEET NO. 3 OF 3 | |
| | | 30 OVER ±0.3 | MATERIAL NO. SEE TABLE | SIZE A3 | | |
| | ANGULAR ±3 ° | DRAFT WHERE APPLICABLE MUST REMAIN WITHIN DIMENSIONS | THIS DRAWING CONTAINS INFORMATION THAT IS PROPRIETARY TO MOLEX INCORPORATED AND SHOULD NOT BE USED WITHOUT WRITTEN PERMISSION | | | |

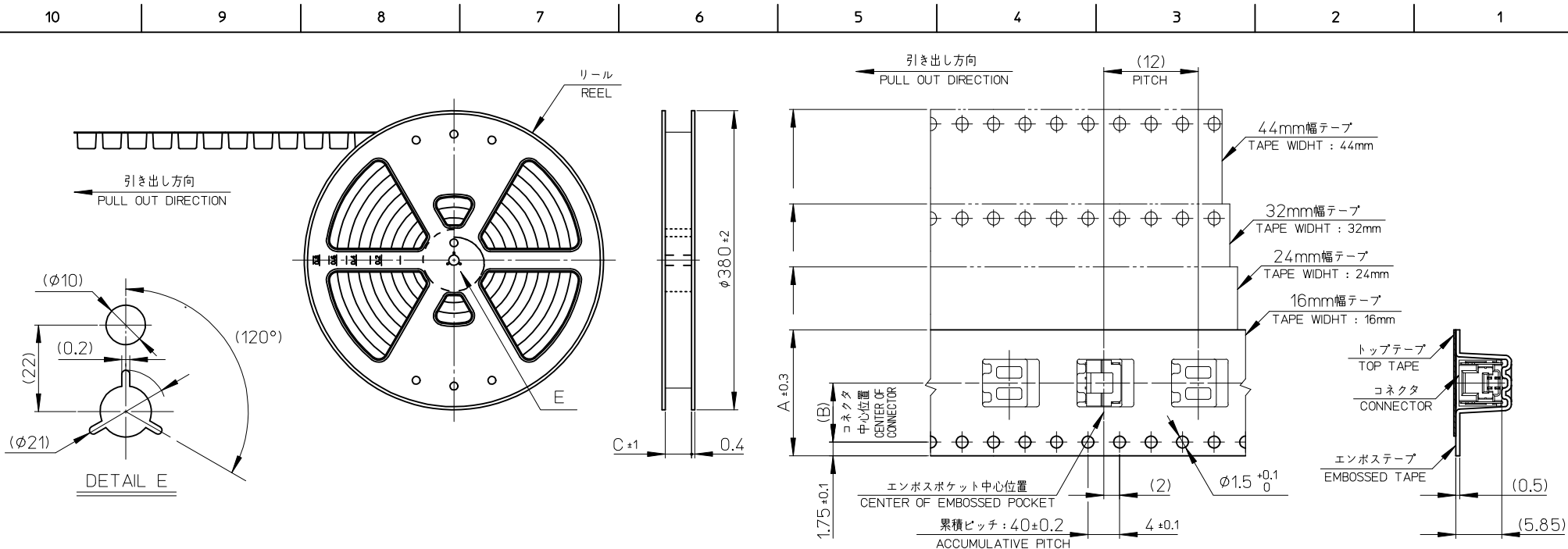

NOTES

- 製品詳細寸法については、SD-502386-001, -002 を参照下さい。
PLEASE REFER TO SD-502386-001, -002 FOR THE DETAILED DIMENSION OF THE CONNECTOR.
- 梱包数量 : 1200個
NUMBER OF CONNECTORS : 1200 PIECES/REEL.
- リードテープ長さ
LEAD TAPE LENGTH

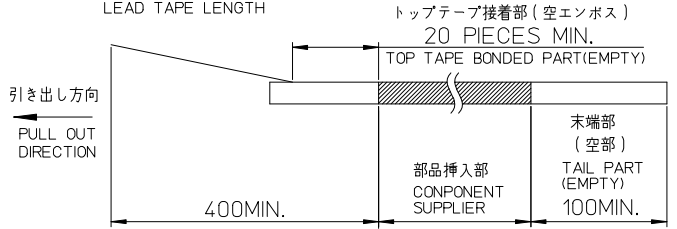

- 材料
MATERIAL
キャリアテープ : ポリスチレン
CARRIER TAPE : POLYSTYRENE
トップテープ : ポリエステル, ポリエチレン, ポリエチレンテレフタレート
TOP TAPE : POLYESTER, POLYETHYLENE, POLYETHYLENE TEREPHTHALATE
リール : ポリスチレン <リサイクル材を含む>
REEL : POLYSTYRENE <RECYCLE MATERIAL CONTAINED>
- ELV 及び RoHS 適合品
ELV AND RoHS COMPLIANT

| | | | | |
|------|------|----|-------------|----|
| 45.5 | 20.2 | 44 | 502386-15** | 15 |
| 45.5 | 20.2 | 44 | 502386-14** | 14 |
| 33.5 | 14.2 | 32 | 502386-13** | 13 |
| 33.5 | 14.2 | 32 | 502386-12** | 12 |
| 33.5 | 14.2 | 32 | 502386-11** | 11 |
| 33.5 | 14.2 | 32 | 502386-10** | 10 |
| 25.5 | 11.5 | 24 | 502386-09** | 9 |
| 25.5 | 11.5 | 24 | 502386-08** | 8 |
| 25.5 | 11.5 | 24 | 502386-07** | 7 |
| 25.5 | 11.5 | 24 | 502386-06** | 6 |
| 25.5 | 11.5 | 24 | 502386-05** | 5 |
| 25.5 | 11.5 | 24 | 502386-04** | 4 |
| 17.5 | 7.5 | 16 | 502386-03** | 3 |
| 17.5 | 7.5 | 16 | 502386-02** | 2 |

| | | | | | | | | | | | |
|--|--------------|--|-------|----------------------------|---|--|------------------------|--|------------------------|--|--|
| REVISED EC NO.: J2013-0870 DRAWN: KWASHIO 2013/02/07 CHKD: KASAKAWA 2013/02/13 APPR: YO ITO 2013/02/13 | DESCRIPTION | GENERAL TOLERANCES (UNLESS SPECIFIED) | | DIMENSION STYLE MM ONLY | | SCALE --- | DESIGN UNITS METRIC | | THIRD ANGLE PROJECTION | | |
| | | 10 UNDER | ±0.2 | DRAWN BY | DATE | TITLE | | | | | |
| | | 10 OVER 30 UNDER | ±0.25 | T. MIYAZAKI | 2006/10/16 | 1.25 W/B CONN. SINGLE R/A REC. EMBTP PKG | | | | | |
| | | 30 OVER | ±0.3 | K. ASAKAWA | 2006/10/16 | molex | | | | | |
| REV | ANGULAR ±3 ° | DRAFT WHERE APPLICABLE MUST REMAIN WITHIN DIMENSIONS | | MATERIAL NO. | DOCUMENT NO. | SHEET NO. | | | | | |
| | | | | SIZE A3 | THIS DRAWING CONTAINS INFORMATION THAT IS PROPRIETARY TO MOLEX INCORPORATED AND SHOULD NOT BE USED WITHOUT WRITTEN PERMISSION | | | | | | |

| WITHOUT CAPTON TAPE | | | WITH CAPTON TAPE | | | | | | | | | | |
|-------------------------------|----------------------|-----------------|-------------------------------|----------------------|-------------------------------|----------------------|-------------------------------|----------------------|-------------------------------|----------------------|-------------------------------|----------------------|-----------------|
| HSG COLOR : ORANGE | | | HSG COLOR : GREEN | | HSG COLOR : BLUE | | HSG COLOR : RED | | HSG COLOR : BLACK | | HSG COLOR : NATURAL | | |
| 502386-**28 | --// | 15 | --// | --// | --// | --// | --// | --// | --// | --// | --// | --// | 15 |
| | --// | 14 | --// | --// | --// | --// | --// | --// | --// | --// | --// | --// | 14 |
| | --// | 13 | --// | --// | --// | --// | --// | --// | --// | --// | --// | --// | 13 |
| | --// | 12 | --// | --// | --// | --// | --// | --// | --// | --// | --// | --// | 12 |
| | --// | 11 | --// | --// | --// | --// | --// | --// | --// | --// | --// | --// | 11 |
| | --// | 10 | --// | --// | --// | --// | --// | --// | --// | --// | --// | --// | 10 |
| | 502386-0948 | 9 | --// | --// | --// | --// | --// | --// | --// | --// | --// | --// | 9 |
| | --// | 8 | --// | --// | --// | --// | --// | --// | --// | --// | --// | --// | 8 |
| | --// | 7 | --// | --// | --// | --// | --// | --// | --// | --// | --// | --// | 7 |
| | --// | 6 | --// | --// | --// | --// | --// | --// | --// | --// | --// | --// | 6 |
| --// | 5 | 502386-0736 | 502386-0636 | 502386-0734 | 502386-0634 | 502386-0732 | 502386-0632 | 502386-0731 | 502386-0631 | 502386-0731 | 502386-0631 | 502386-0772 | 7 |
| --// | 4 | 502386-0536 | 502386-0436 | 502386-0534 | 502386-0434 | 502386-0532 | 502386-0432 | 502386-0531 | 502386-0431 | 502386-0531 | 502386-0431 | 502386-0572 | 5 |
| --// | 3 | 502386-0436 | 502386-0336 | 502386-0434 | 502386-0334 | 502386-0432 | 502386-0332 | 502386-0431 | 502386-0331 | 502386-0431 | 502386-0331 | 502386-0472 | 4 |
| --// | 2 | 502386-0336 | 502386-0236 | 502386-0334 | 502386-0234 | 502386-0332 | 502386-0232 | 502386-0331 | 502386-0231 | 502386-0331 | 502386-0231 | 502386-0372 | 3 |
| --// | 2 | 502386-0236 | 502386-0136 | 502386-0234 | 502386-0134 | 502386-0232 | 502386-0132 | 502386-0231 | 502386-0131 | 502386-0231 | 502386-0131 | 502386-0272 | 2 |
| コネクタ シリーズ CONNECTOR SERIES | 製品番号 MATERIAL NO. | 極数 (KT. NO.) | コネクタ シリーズ CONNECTOR SERIES | 製品番号 MATERIAL NO. | コネクタ シリーズ CONNECTOR SERIES | 製品番号 MATERIAL NO. | コネクタ シリーズ CONNECTOR SERIES | 製品番号 MATERIAL NO. | コネクタ シリーズ CONNECTOR SERIES | 製品番号 MATERIAL NO. | コネクタ シリーズ CONNECTOR SERIES | 製品番号 MATERIAL NO. | 極数 (KT. NO.) |

| WITHOUT CAPTON TAPE | | | | | | | | | | | | | | | | | |
|---------------------|-------------------------------|----------------------|-------------------------------|----------------------|-------------------------------|----------------------|-------------------------------|----------------------|-------------------------------|----------------------|-------------------------------|----------------------|-----------------|--|---------------------|--|--|
| HSG COLOR : GREEN | | | HSG COLOR : BLUE | | | HSG COLOR : YELLOW | | | HSG COLOR : RED | | | HSG COLOR : BLACK | | | HSG COLOR : NATURAL | | |
| 502386-**26 | 502386-1546 | 502386-1544 | --// | 502386-1542 | 502386-1541 | 502386-1570 | 15 | | | | | | | | | | |
| | 502386-1446 | 502386-1444 | --// | 502386-1442 | 502386-1441 | 502386-1470 | 14 | | | | | | | | | | |
| | 502386-1346 | 502386-1344 | --// | 502386-1342 | 502386-1341 | 502386-1370 | 13 | | | | | | | | | | |
| | 502386-1246 | 502386-1244 | --// | 502386-1242 | 502386-1241 | 502386-1270 | 12 | | | | | | | | | | |
| | 502386-1146 | 502386-1144 | --// | 502386-1142 | 502386-1141 | 502386-1170 | 11 | | | | | | | | | | |
| | 502386-1046 | 502386-1044 | --// | 502386-1042 | 502386-1041 | 502386-1070 | 10 | | | | | | | | | | |
| | 502386-0946 | 502386-0944 | 502386-0943 | 502386-0942 | 502386-0941 | 502386-0970 | 9 | | | | | | | | | | |
| | 502386-0846 | 502386-0844 | --// | 502386-0842 | 502386-0841 | 502386-0870 | 8 | | | | | | | | | | |
| | 502386-0746 | 502386-0744 | --// | 502386-0742 | 502386-0741 | 502386-0770 | 7 | | | | | | | | | | |
| | 502386-0646 | 502386-0644 | --// | 502386-0642 | 502386-0641 | 502386-0670 | 6 | | | | | | | | | | |
| | 502386-0546 | 502386-0544 | --// | 502386-0542 | 502386-0541 | 502386-0570 | 5 | | | | | | | | | | |
| | 502386-0446 | 502386-0444 | --// | 502386-0442 | 502386-0441 | 502386-0470 | 4 | | | | | | | | | | |
| | 502386-0346 | 502386-0344 | --// | 502386-0342 | 502386-0341 | 502386-0370 | 3 | | | | | | | | | | |
| | 502386-0246 | 502386-0244 | --// | 502386-0242 | 502386-0241 | 502386-0270 | 2 | | | | | | | | | | |
| | コネクタ シリーズ CONNECTOR SERIES | 製品番号 MATERIAL NO. | コネクタ シリーズ CONNECTOR SERIES | 製品番号 MATERIAL NO. | コネクタ シリーズ CONNECTOR SERIES | 製品番号 MATERIAL NO. | コネクタ シリーズ CONNECTOR SERIES | 製品番号 MATERIAL NO. | コネクタ シリーズ CONNECTOR SERIES | 製品番号 MATERIAL NO. | コネクタ シリーズ CONNECTOR SERIES | 製品番号 MATERIAL NO. | 極数 (KT. NO.) | | | | |

| | | | | | | | |
|---|---------------------------------------|-----------|-----------------------------------|---------------|---|-------------------------------|------------------------|
| REVISED EC NO.: J2013-0870 DRWN: KWASHIO 2013/02/13 CHKD: KASAKAWA 2013/02/13 APPR: Y0 ITO 2013/02/13 | GENERAL TOLERANCES (UNLESS SPECIFIED) | | DIMENSION STYLE MM ONLY | | SCALE --- | DESIGN UNITS METRIC | THIRD ANGLE PROJECTION |
| | 10 UNDER | ±0.2 | DRAWN BY | DATE | TITLE | | |
| | 10 OVER 30 UNDER | ±0.25 | T. MIYAZAKI | 2006/10/16 | 1.25 W/B CONN. SINGLE R/A REC. EMBTP PKG | | |
| | 30 OVER | ±0.3 | K. ASAKAWA | 2006/10/16 |  | | |
| | ANGULAR ±3 ° | | APPROVED BY | DATE | MATERIAL NO. | DOCUMENT NO. | SHEET NO. |
| DRAFT WHERE APPLICABLE MUST REMAIN WITHIN DIMENSIONS | | SEE TABLE | | SD-502386-003 | | 2 OF 2 | |
| THIS DRAWING CONTAINS INFORMATION THAT IS PROPRIETARY TO MOLEX INCORPORATED AND SHOULD NOT BE USED WITHOUT WRITTEN PERMISSION | | | | | | | |