

PART NUMBER	ITEM ① BOLT	ITEM ② NUT	ITEM ③ FLAT-WASHER	ITEM ④ SPRING-WASHER
40-98440F-C	BRASS NICKEL PLATED	STEEL NICKEL PLATED	STEEL NICKEL PLATED	STEEL NICKEL PLATED

REV	ECO	DATE
002	ECO-11-0127	07/26/2011
003	ECO-12-0335	12/19/2012
004	ECO-18-0023	09/04/2018

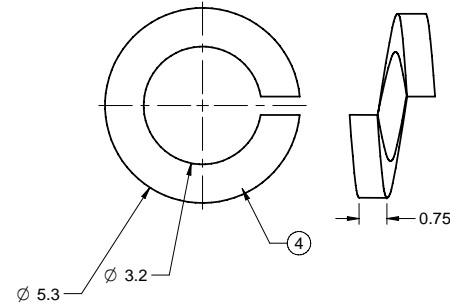
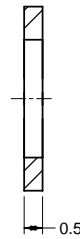
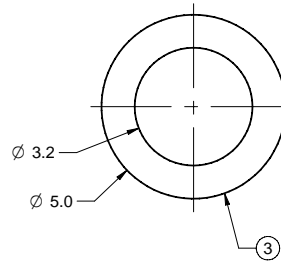
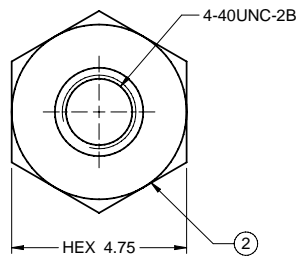
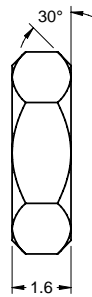
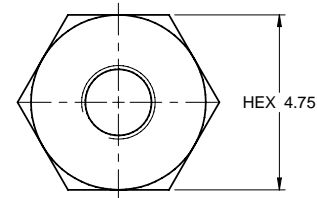
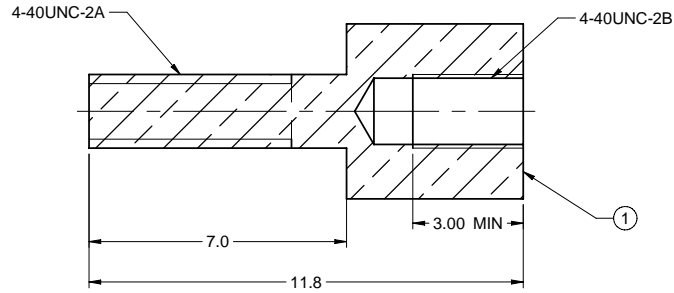

NOTES:

1. PRODUCT SHOULD BE RoHS COMPLIANCE.
2. PACKAGING REQUIREMENT FOLLOWS ENGINEER DOCUMENT P/N 836-40200001XX

40-98440F-C	F SCREW LOCKS,.30°(50 SET)
40-98440F	F SCREW LOCKS,.30°(1 SET)

	Model No. 40-98440F-C	Title: AIM-Cambridge F SCREW LOCKS, .30° (1 SET)	
	RoHS2 <input checked="" type="checkbox"/> 2011/65/EU	Cage Code N/A	
	UNLESS OTHERWISE SPECIFIED: X ±.5 X ±.2 XX ±.1 ANGLES 5°	Drawn By: Betty Yu	
	INTERPRET DRAWING IN ACCORDANCE WITH ASME Y14.2-2009	Date: 09/04/2018	Size B