

ESD7004, SZESD7004

SD Protection Diode

Low Capacitance ESD Protection Diode for High Speed Data Line

The ESD7004 surge protection is designed to protect high speed data lines from ESD. Ultra-low capacitance and low ESD clamping voltage make this device an ideal solution for protecting voltage sensitive high speed data lines. The flow-through style package allows for easy PCB layout and matched trace lengths necessary to maintain consistent impedance between high speed differential lines such as USB 3.0 and HDMI.

Features

- Low Capacitance (0.4 pF Typical, I/O to GND)
- Protection for the Following IEC Standards:
IEC 61000-4-2 (Level 4)
- Low ESD Clamping Voltage
- SZ Prefix for Automotive and Other Applications Requiring Unique Site and Control Change Requirements; AEC-Q101 Qualified and PPAP Capable
- This is a Pb-Free Device

Typical Applications

- USB 3.0
- HDMI
- Display Port
- eSATA

MAXIMUM RATINGS (T_J = 25°C unless otherwise noted)

| Rating | Symbol | Value | Unit |
|--|------------------|-------------|------|
| Operating Junction Temperature Range | T _J | -55 to +125 | °C |
| Storage Temperature Range | T _{stg} | -55 to +150 | °C |
| Lead Solder Temperature - Maximum (10 Seconds) | T _L | 260 | °C |
| IEC 61000-4-2 Contact (ESD) | ESD | ±15 | kV |
| IEC 61000-4-2 Air (ESD) | ESD | ±15 | kV |

Stresses exceeding those listed in the Maximum Ratings table may damage the device. If any of these limits are exceeded, device functionality should not be assumed, damage may occur and reliability may be affected.

See Application Note AND8308/D for further description of survivability specs.



ON Semiconductor®

www.onsemi.com

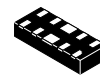

UDFN10
CASE 517BB

MARKING DIAGRAM

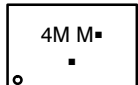

4M = Specific Device Code (tbd)
M = Date Code
▪ = Pb-Free Package

(Note: Microdot may be in either location)

PIN CONFIGURATION AND SCHEMATIC

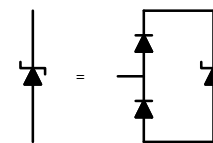
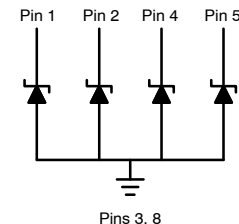
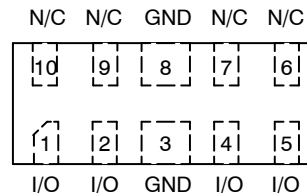

ORDERING INFORMATION

| Device | Package | Shipping |
|----------------|------------------|--------------------|
| ESD7004MUTAG | UDFN10 (Pb-Free) | 3000 / Tape & Reel |
| SZESD7004MUTAG | UDFN10 (Pb-Free) | 3000 / Tape & Reel |

†For information on tape and reel specifications, including part orientation and tape sizes, please refer to our Tape and Reel Packaging Specification Brochure, BRD8011/D.

ESD7004, SZESD7004

ELECTRICAL CHARACTERISTICS ($T_A = 25^\circ\text{C}$ unless otherwise specified)

| Parameter | Symbol | Conditions | Min | Typ | Max | Unit |
|--|-----------|--|---------------------|------------------------------|-----|---------------|
| Reverse Working Voltage | V_{RWM} | I/O Pin to GND | | | 5.0 | V |
| Breakdown Voltage | V_{BR} | $I_T = 1\text{ mA}$, I/O Pin to GND | 5.5 | | | V |
| Reverse Leakage Current | I_R | $V_{RWM} = 5\text{ V}$, I/O Pin to GND | | | 1.0 | μA |
| Clamping Voltage (Note 1) | V_C | $I_{PP} = 1\text{ A}$, I/O Pin to GND (8 x 20 μs pulse) | | | 10 | V |
| Clamping Voltage (Note 2) | V_C | IEC61000-4-2, $\pm 8\text{ KV}$ Contact | See Figures 1 and 2 | | | V |
| Clamping Voltage TLP (Note 3) See Figures 6 through 9 | V_C | $I_{PP} = 8\text{ A}$ $I_{PP} = 16\text{ A}$ $I_{PP} = -8\text{ A}$ $I_{PP} = -16\text{ A}$ | | 11.4 15.6 -4.5 -8.1 | | |
| Junction Capacitance | C_J | $V_R = 0\text{ V}$, $f = 1\text{ MHz}$ between I/O Pins | | 0.2 | 0.3 | pF |
| Junction Capacitance | C_J | $V_R = 0\text{ V}$, $f = 1\text{ MHz}$ between I/O Pins and GND | | 0.4 | 0.5 | pF |

- Surge current waveform per Figure 5.
- For test procedure see Figures 3 and 4 and application note AND8307/D.
- ANSI/ESD STM5.5.1 – Electrostatic Discharge Sensitivity Testing using Transmission Line Pulse (TLP) Model.
TLP conditions: $Z_0 = 50\ \Omega$, $t_p = 100\text{ ns}$, $t_r = 4\text{ ns}$, averaging window; $t_1 = 30\text{ ns}$ to $t_2 = 60\text{ ns}$.

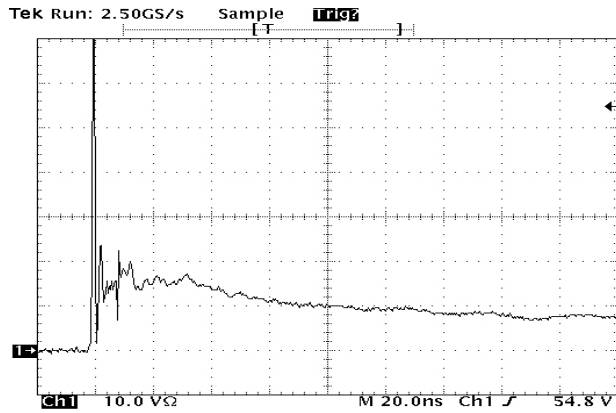

Figure 1. IEC61000-4-2 +8 KV Contact ESD Clamping Voltage

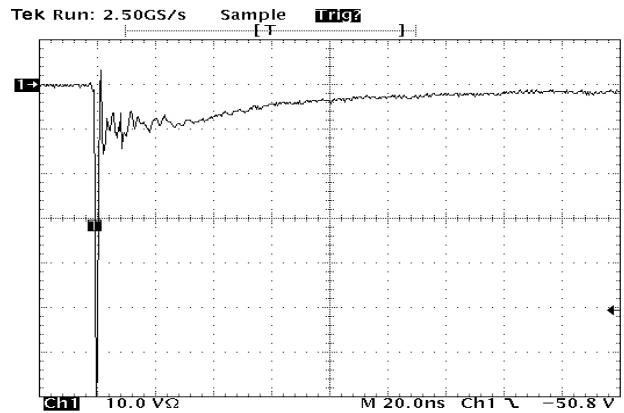

Figure 2. IEC61000-4-2 -8 KV Contact ESD Clamping Voltage

ESD7004, SZESD7004

IEC 61000-4-2 Spec.

| Level | Test Voltage (kV) | First Peak Current (A) | Current at 30 ns (A) | Current at 60 ns (A) |
|-------|-------------------|------------------------|----------------------|----------------------|
| 1 | 2 | 7.5 | 4 | 2 |
| 2 | 4 | 15 | 8 | 4 |
| 3 | 6 | 22.5 | 12 | 6 |
| 4 | 8 | 30 | 16 | 8 |



Figure 3. IEC61000-4-2 Spec

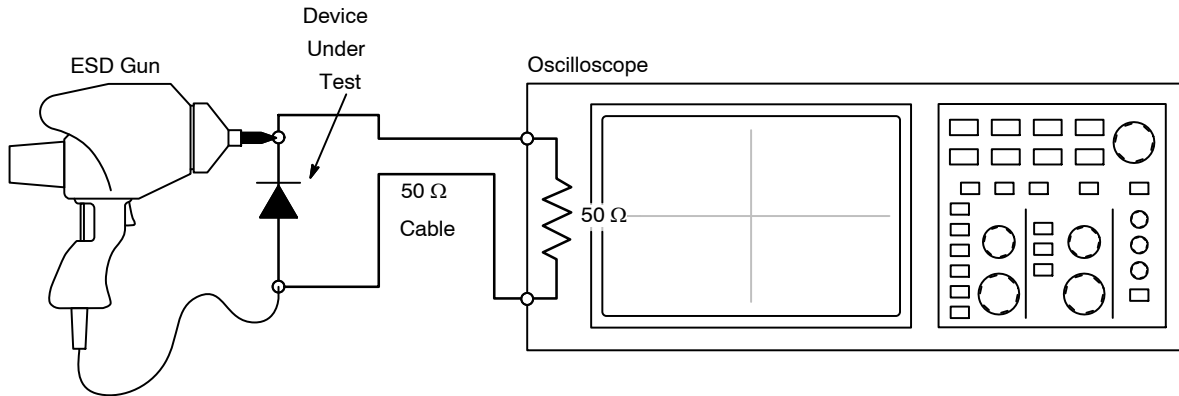

Figure 4. Diagram of ESD Clamping Voltage Test Setup

The following is taken from Application Note AND8308/D – Interpretation of Datasheet Parameters for ESD Devices.

ESD Voltage Clamping

For sensitive circuit elements it is important to limit the voltage that an IC will be exposed to during an ESD event to as low a voltage as possible. The ESD clamping voltage is the voltage drop across the ESD protection diode during an ESD event per the IEC61000-4-2 waveform. Since the IEC61000-4-2 was written as a pass/fail spec for larger

systems such as cell phones or laptop computers it is not clearly defined in the spec how to specify a clamping voltage at the device level. ON Semiconductor has developed a way to examine the entire voltage waveform across the ESD protection diode over the time domain of an ESD pulse in the form of an oscilloscope screenshot, which can be found on the datasheets for all ESD protection diodes. For more information on how ON Semiconductor creates these screenshots and how to interpret them please refer to AND8307/D.

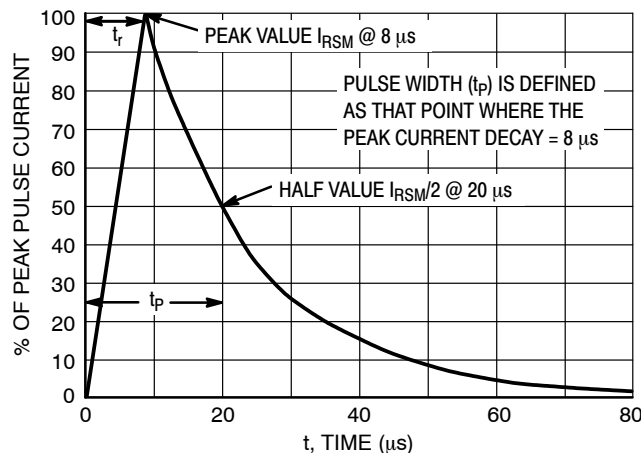

Figure 5. 8 x 20 μs Pulse Waveform

ESD7004, SZESD7004

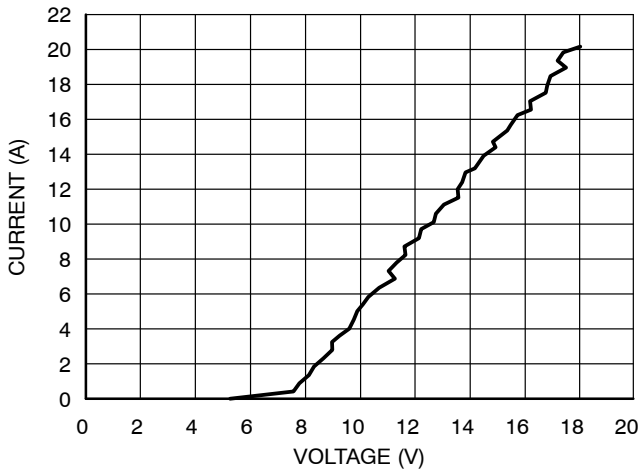

Figure 6. Positive TLP I-V Curve

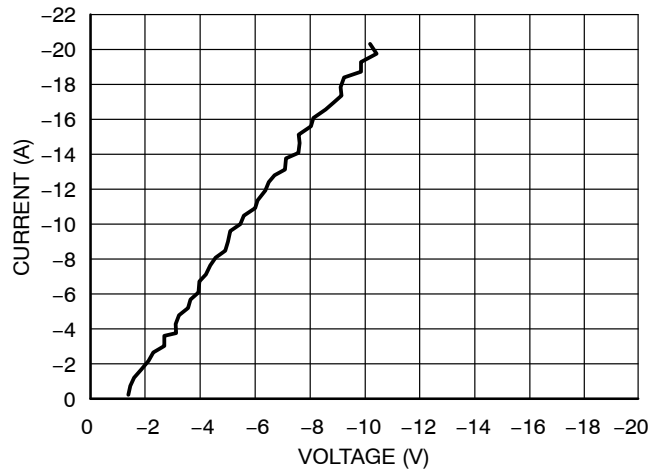

Figure 7. Negative TLP I-V Curve

Transmission Line Pulse (TLP) Measurement

Transmission Line Pulse (TLP) provides current versus voltage (I-V) curves in which each data point is obtained from a 100 ns long rectangular pulse from a charged transmission line. A simplified schematic of a typical TLP system is shown in Figure 8. TLP I-V curves of ESD protection devices accurately demonstrate the product's ESD capability because the 10s of amps current levels and

under 100 ns time scale match those of an ESD event. This is illustrated in Figure 9 where an 8 kV IEC 61000-4-2 current waveform is compared with TLP current pulses at 8 A and 16 A. A TLP I-V curve shows the voltage at which the device turns on as well as how well the device clamps voltage over a range of current levels. A typical TLP I-V curve for the ESD7004 is shown in Figures 6 and 7.

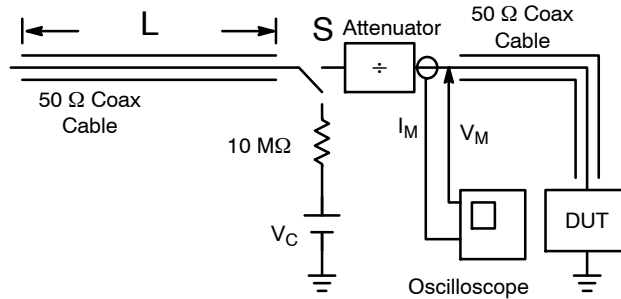

Figure 8. Simplified Schematic of a Typical TLP System

ESD7004, SZESD7004

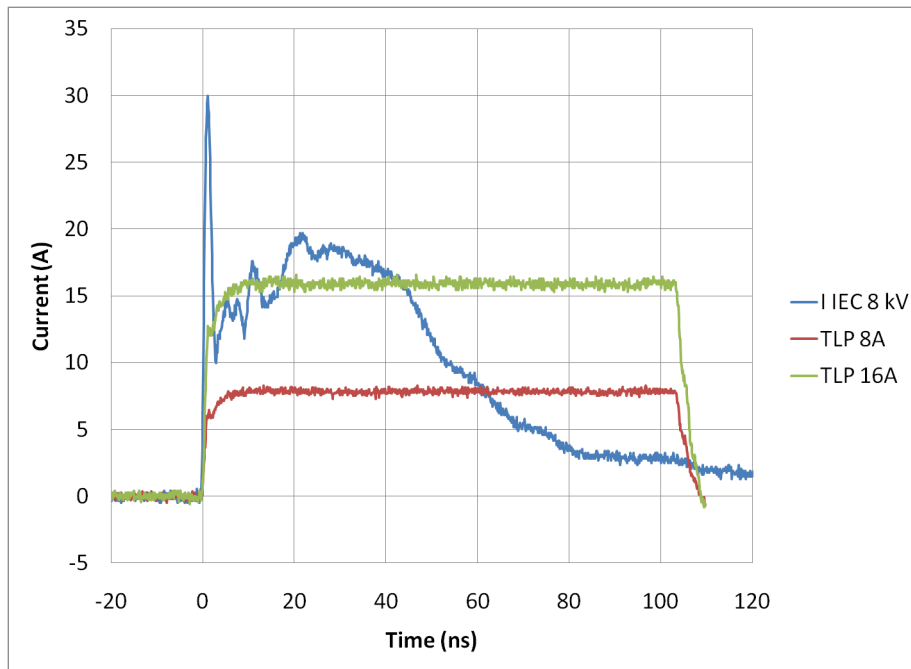
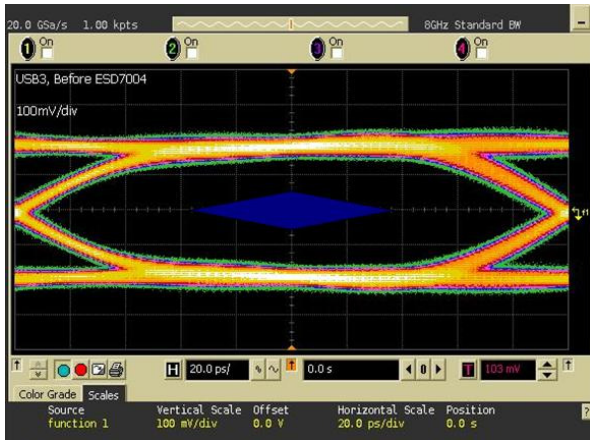
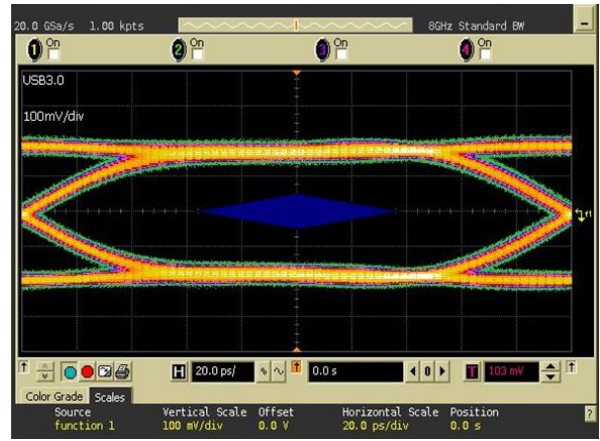

Figure 9. Comparison Between 8 kV IEC 61000-4-2 and 8 A and 16 A TLP Waveforms

ESD7004, SZESD7004



Without ESD



With ESD7004

Figure 10. USB3.0 Eye Diagram with and without ESD7004. 5.0 Gb/s, 400 mV_{pp}

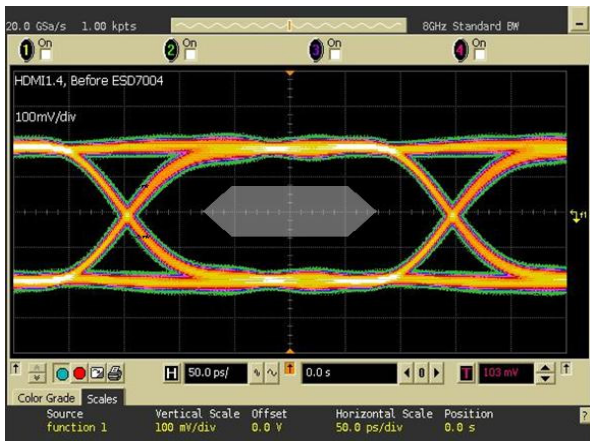

Without ESD

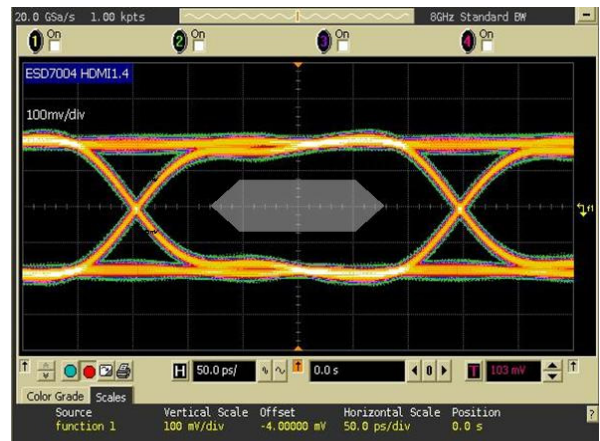

With ESD7004

Figure 11. HDMI1.4 Eye Diagram with and without ESD7004. 3.4 Gb/s, 400 mV_{pp}

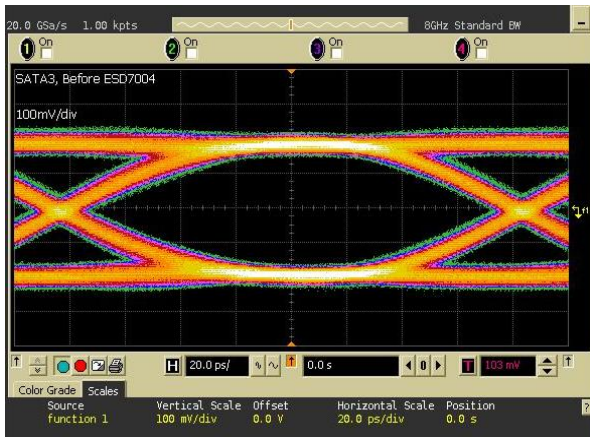

Without ESD

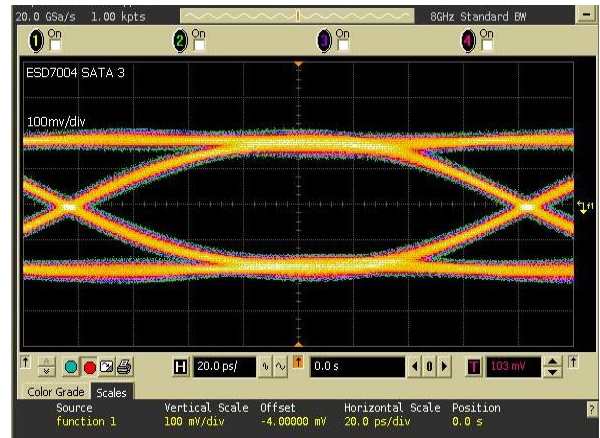

With ESD7004

Figure 12. ESATA3.0 Eye Diagram with and without ESD7004. 6 Gb/s, 400 mV_{pp}

ESD7004, SZESD7004

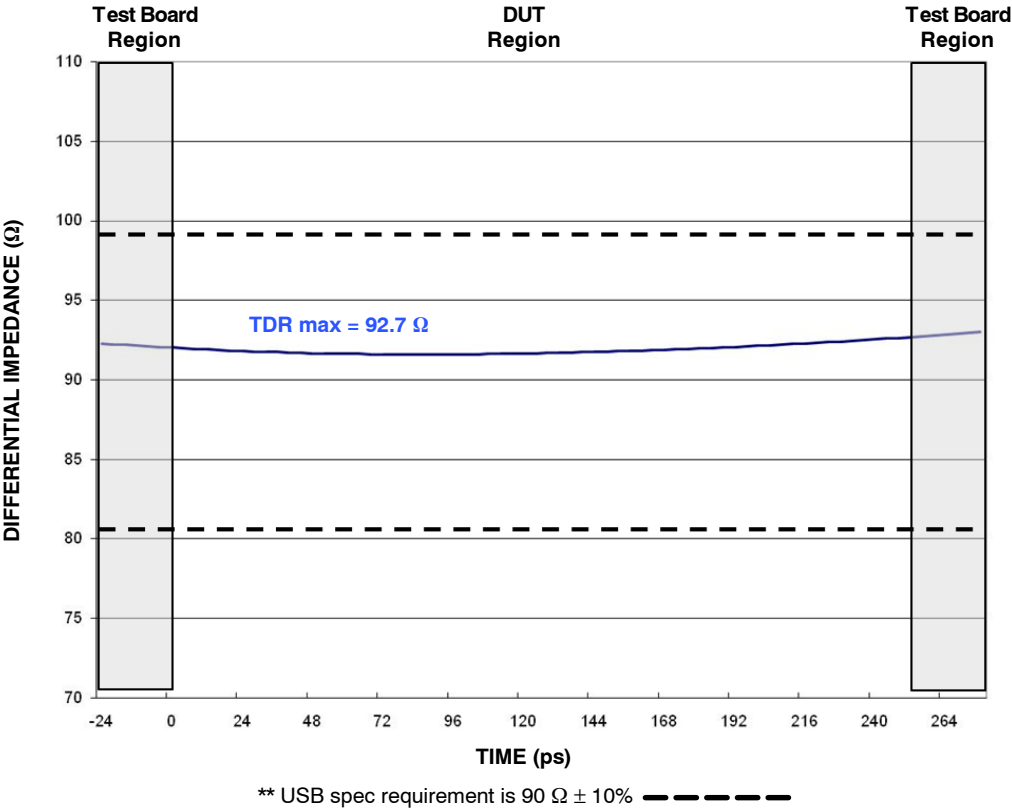

Figure 13. USB TDR Measurement. 90 Ω Differential Impedance Target, 200 ps Rise Time

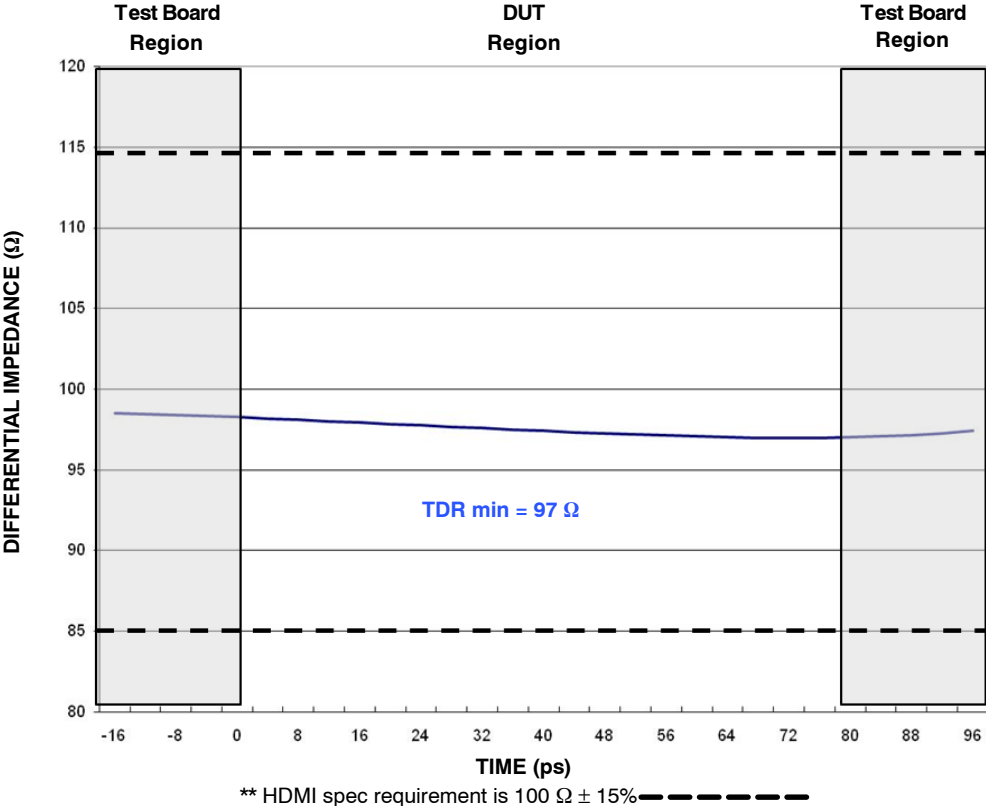

Figure 14. HDMI TDR Measurement. 100 Ω Differential Impedance Target, 200 ps Rise Time

ESD7004, SZESD7004

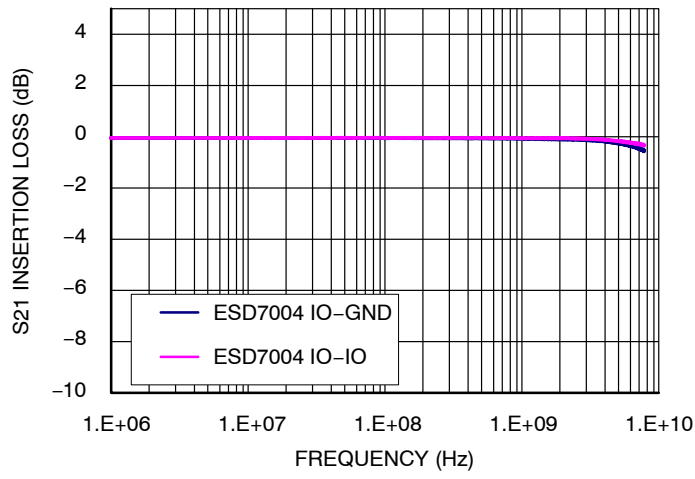

Figure 15. ESD7004 Insertion Loss

ESD7004, SZESD7004

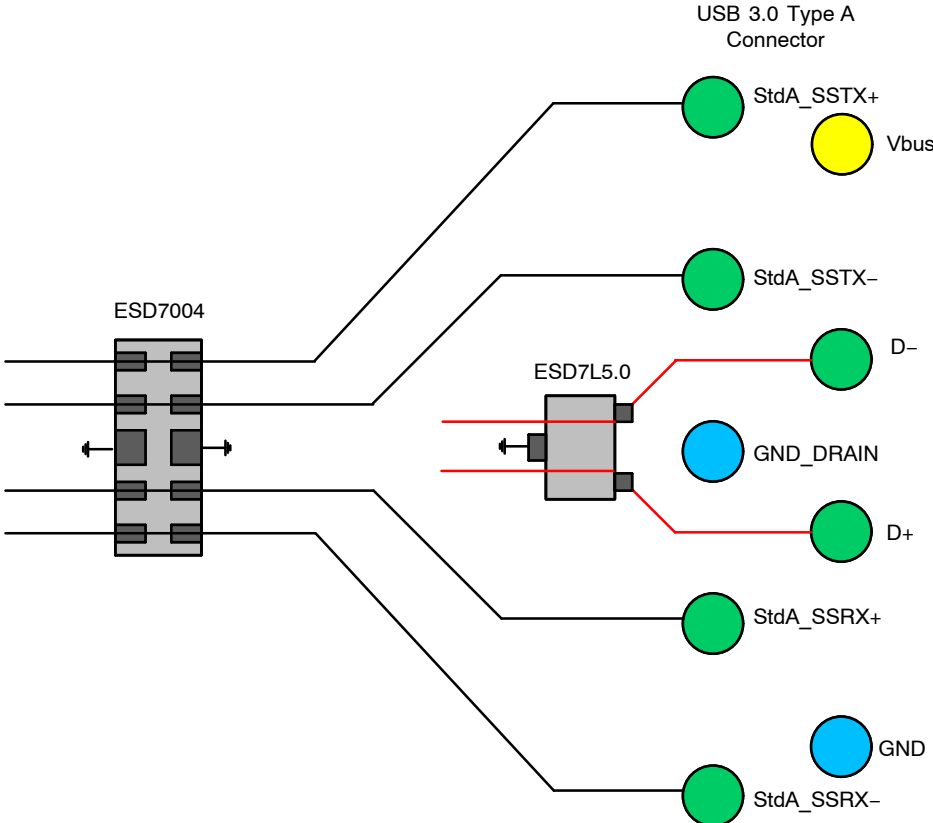

Figure 16. USB3.0 Standard A Connector Layout Diagram

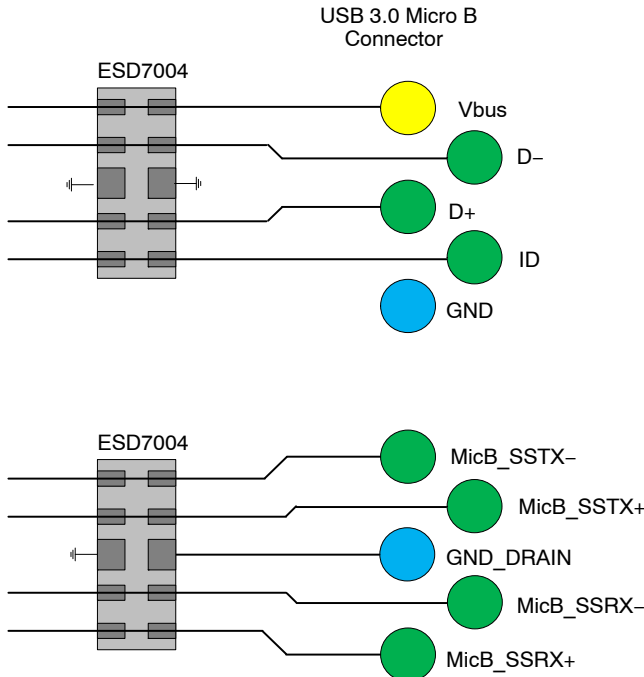

Figure 17. USB3.0 Micro B Connector Layout Diagram

ESD7004, SZESD7004

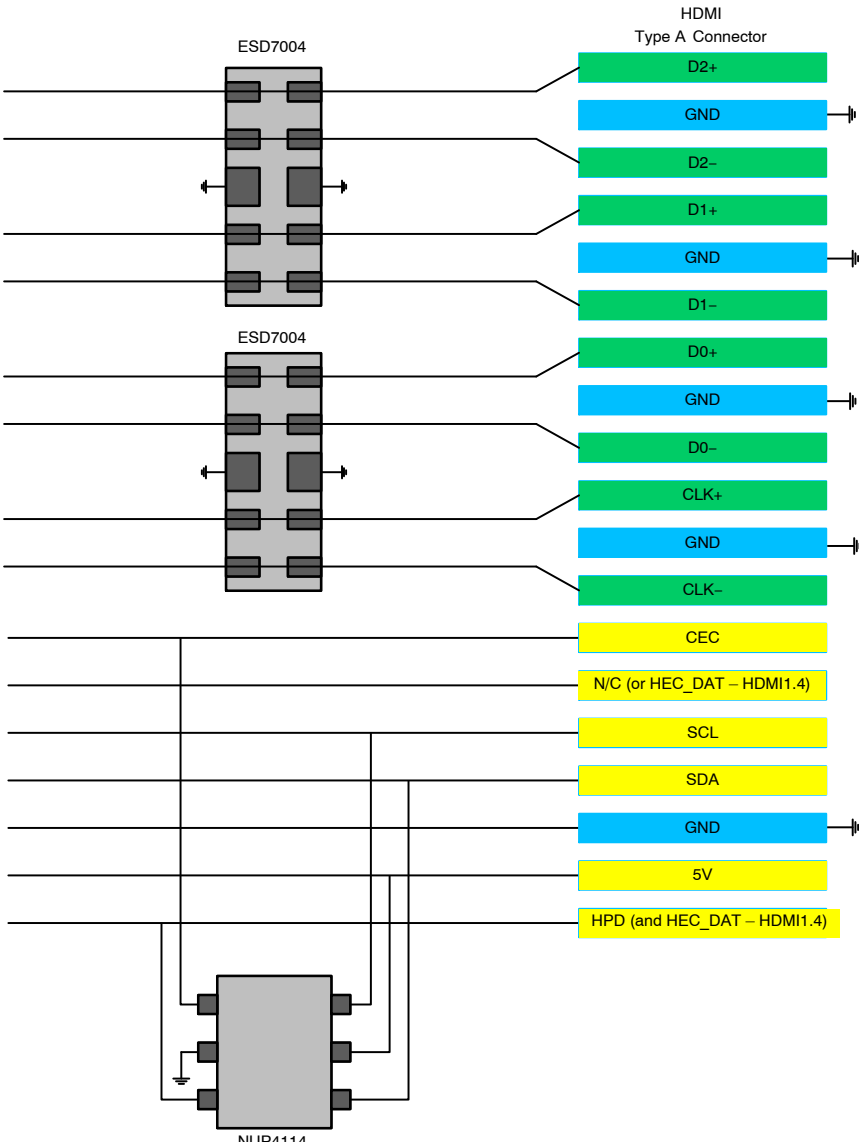

Figure 18. HDMI Layout Diagram

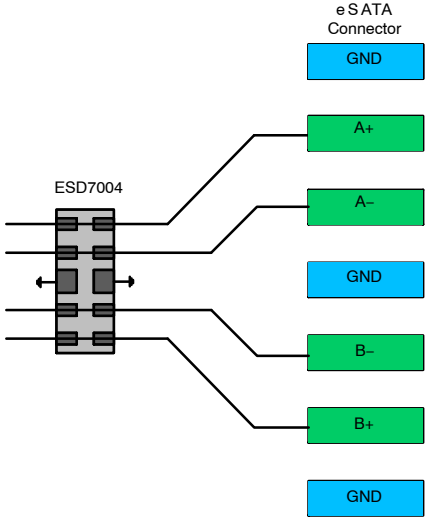

Figure 19. eSATA Layout Diagram

MECHANICAL CASE OUTLINE

PACKAGE DIMENSIONS

ON Semiconductor®



UDFN10 2.5x1, 0.5P
CASE 517BB-01
ISSUE O

DATE 17 NOV 2009

SCALE 4:1

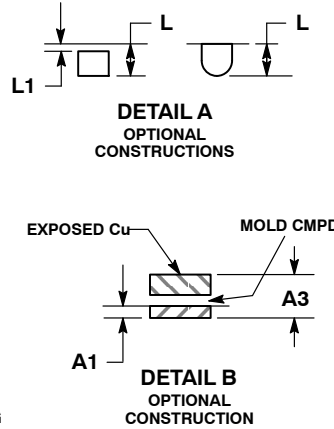

- NOTES:
1. DIMENSIONING AND TOLERANCING PER ASME Y14.5M, 1994.
 2. CONTROLLING DIMENSION: MILLIMETERS.
 3. DIMENSION b APPLIES TO PLATED TERMINAL AND IS MEASURED BETWEEN 0.15 AND 0.30mm FROM TERMINAL.

| DIM | MILLIMETERS | |
|-----|-------------|------|
| | MIN | MAX |
| A | 0.45 | 0.55 |
| A1 | 0.00 | 0.05 |
| A3 | 0.13 REF | |
| b | 0.15 | 0.25 |
| b2 | 0.35 | 0.45 |
| D | 2.50 BSC | |
| E | 1.00 BSC | |
| e | 0.50 BSC | |
| L | 0.30 | 0.40 |
| L1 | --- | 0.05 |

GENERIC MARKING DIAGRAM*

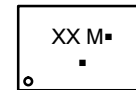

- XXX = Specific Device Code
- M = Date Code
- = Pb-Free Package

(Note: Microdot may be in either location)

*This information is generic. Please refer to device data sheet for actual part marking. Pb-Free indicator, "G" or microdot "▪", may or may not be present.

RECOMMENDED SOLDERING FOOTPRINT*

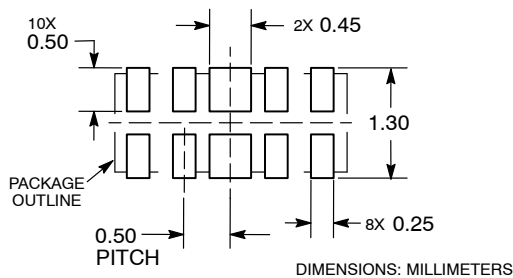

*For additional information on our Pb-Free strategy and soldering details, please download the ON Semiconductor Soldering and Mounting Techniques Reference Manual, SOLDERRM/D.

| | | |
|-------------------------|---------------------------|--|
| DOCUMENT NUMBER: | 98AON47059E | Electronic versions are uncontrolled except when accessed directly from the Document Repository. Printed versions are uncontrolled except when stamped "CONTROLLED COPY" in red. |
| DESCRIPTION: | UDFN10 2.5X1, 0.5P | PAGE 1 OF 1 |

ON Semiconductor and are trademarks of Semiconductor Components Industries, LLC dba ON Semiconductor or its subsidiaries in the United States and/or other countries. ON Semiconductor reserves the right to make changes without further notice to any products herein. ON Semiconductor makes no warranty, representation or guarantee regarding the suitability of its products for any particular purpose, nor does ON Semiconductor assume any liability arising out of the application or use of any product or circuit, and specifically disclaims any and all liability, including without limitation special, consequential or incidental damages. ON Semiconductor does not convey any license under its patent rights nor the rights of others.

onsemi, **Onsemi**, and other names, marks, and brands are registered and/or common law trademarks of Semiconductor Components Industries, LLC dba "**onsemi**" or its affiliates and/or subsidiaries in the United States and/or other countries. **onsemi** owns the rights to a number of patents, trademarks, copyrights, trade secrets, and other intellectual property. A listing of **onsemi**'s product/patent coverage may be accessed at www.onsemi.com/site/pdf/Patent-Marking.pdf. **onsemi** reserves the right to make changes at any time to any products or information herein, without notice. The information herein is provided "as-is" and **onsemi** makes no warranty, representation or guarantee regarding the accuracy of the information, product features, availability, functionality, or suitability of its products for any particular purpose, nor does **onsemi** assume any liability arising out of the application or use of any product or circuit, and specifically disclaims any and all liability, including without limitation special, consequential or incidental damages. Buyer is responsible for its products and applications using **onsemi** products, including compliance with all laws, regulations and safety requirements or standards, regardless of any support or applications information provided by **onsemi**. "Typical" parameters which may be provided in **onsemi** data sheets and/or specifications can and do vary in different applications and actual performance may vary over time. All operating parameters, including "Typicals" must be validated for each customer application by customer's technical experts. **onsemi** does not convey any license under any of its intellectual property rights nor the rights of others. **onsemi** products are not designed, intended, or authorized for use as a critical component in life support systems or any FDA Class 3 medical devices or medical devices with a same or similar classification in a foreign jurisdiction or any devices intended for implantation in the human body. Should Buyer purchase or use **onsemi** products for any such unintended or unauthorized application, Buyer shall indemnify and hold **onsemi** and its officers, employees, subsidiaries, affiliates, and distributors harmless against all claims, costs, damages, and expenses, and reasonable attorney fees arising out of, directly or indirectly, any claim of personal injury or death associated with such unintended or unauthorized use, even if such claim alleges that **onsemi** was negligent regarding the design or manufacture of the part. **onsemi** is an Equal Opportunity/Affirmative Action Employer. This literature is subject to all applicable copyright laws and is not for resale in any manner.

PUBLICATION ORDERING INFORMATION

LITERATURE FULFILLMENT:

Email Requests to: orderlit@onsemi.com

onsemi Website: www.onsemi.com

TECHNICAL SUPPORT

North American Technical Support:
Voice Mail: 1 800-282-9855 Toll Free USA/Canada
Phone: 011 421 33 790 2910

Europe, Middle East and Africa Technical Support:

Phone: 00421 33 790 2910

For additional information, please contact your local Sales Representative