

MMBT6428LT1G, MMBT6429LT1G, NSVMMBT6429LT1G

Amplifier Transistors

NPN Silicon



ON Semiconductor®

www.onsemi.com

Features

- NSV Prefix for Automotive and Other Applications Requiring Unique Site and Control Change Requirements; AEC-Q101 Qualified and PPAP Capable
- These Devices are Pb-Free, Halogen Free/BFR Free and are RoHS Compliant

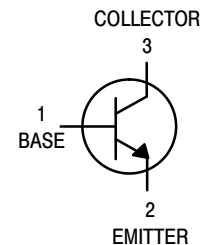

MAXIMUM RATINGS

Rating	Symbol	6428LT1	6429LT1	Unit
Collector–Emitter Voltage	V_{CEO}	50	45	Vdc
Collector–Base Voltage	V_{CBO}	60	55	Vdc
Emitter–Base Voltage	V_{EBO}	6.0		Vdc
Collector Current – Continuous	I_C	200		mAdc

Stresses exceeding those listed in the Maximum Ratings table may damage the device. If any of these limits are exceeded, device functionality should not be assumed, damage may occur and reliability may be affected.

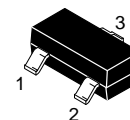

SOT-23 (TO-236)
CASE 318
STYLE 6

THERMAL CHARACTERISTICS

Rating	Symbol	Value	Unit
Total Device Dissipation FR-5 Board (Note 1) $T_A = 25^\circ\text{C}$ Derate above 25°C	P_D	225	mW
		1.8	mW/ $^\circ\text{C}$
Thermal Resistance, Junction–to–Ambient	$R_{\theta JA}$	556	$^\circ\text{C}/\text{W}$
Total Device Dissipation Alumina Substrate, (Note 2) $T_A = 25^\circ\text{C}$ Derate above 25°C	P_D	300	mW
		2.4	mW/ $^\circ\text{C}$
Thermal Resistance, Junction–to–Ambient	$R_{\theta JA}$	417	$^\circ\text{C}/\text{W}$
Junction and Storage Temperature	T_J, T_{stg}	-55 to +150	$^\circ\text{C}$

1. FR-5 = $1.0 \times 0.75 \times 0.062$ in.
2. Alumina = $0.4 \times 0.3 \times 0.024$ in. 99.5% alumina.

MARKING DIAGRAM

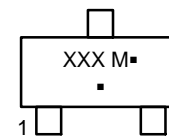

XXX = Specific Device Code
MMBT6428LT1 – 1KM
NSV/MMBT6429LT1 – M1L
M = Date Code*
■ = Pb-Free Package

(Note: Microdot may be in either location)

*Date Code orientation and/or overbar may vary depending upon manufacturing location.

ORDERING INFORMATION

Device	Package	Shipping†
MMBT6428LT1G	SOT-23 (Pb-Free)	3000 Tape & Reel
MMBT6429LT1G	SOT-23 (Pb-Free)	3000 Tape & Reel
NSVMMBT6429LT1G	SOT-23 (Pb-Free)	3000 Tape & Reel

†For information on tape and reel specifications, including part orientation and tape sizes, please refer to our Tape and Reel Packaging Specifications Brochure, BRD8011/D.

MMBT6428LT1G, MMBT6429LT1G, NSVMMBT6429LT1G

ELECTRICAL CHARACTERISTICS (T_A = 25°C unless otherwise noted)

Characteristic	Symbol	Min	Max	Unit	
OFF CHARACTERISTICS					
Collector–Emitter Breakdown Voltage (I _C = 1.0 mA _{dc} , I _B = 0) (I _C = 1.0 mA _{dc} , I _B = 0)	MMBT6428 MMBT6429 / NSVMMBT6429	V _{(BR)CEO}	50 45	– –	V _{dc}
Collector–Base Breakdown Voltage (I _C = 0.1 mA _{dc} , I _E = 0) (I _C = 0.1 mA _{dc} , I _E = 0)	MMBT6428 MMBT6429 / NSVMMBT6429	V _{(BR)CBO}	60 55	– –	V _{dc}
Collector Cutoff Current (V _{CE} = 30 V _{dc})		I _{CES}	–	0.1	μA _{dc}
Collector Cutoff Current (V _{CB} = 30 V _{dc} , I _E = 0)		I _{CBO}	–	0.01	μA _{dc}
Emitter Cutoff Current (V _{EB} = 5.0 V _{dc} , I _C = 0)		I _{EBO}	–	0.01	μA _{dc}

ON CHARACTERISTICS

DC Current Gain (I _C = 0.01 mA _{dc} , V _{CE} = 5.0 V _{dc}) (I _C = 0.1 mA _{dc} , V _{CE} = 5.0 V _{dc}) (I _C = 1.0 mA _{dc} , V _{CE} = 5.0 V _{dc}) (I _C = 10 mA _{dc} , V _{CE} = 5.0 V _{dc})	MMBT6428 MMBT6429 / NSVMMBT6429 MMBT6428 MMBT6429 / NSVMMBT6429 MMBT6428 MMBT6429 / NSVMMBT6429 MMBT6428 MMBT6429 / NSVMMBT6429	h _{FE}	250 500 250 500 250 500 250 500	– – 650 1250 – – – –	–
Collector–Emitter Saturation Voltage (I _C = 10 mA _{dc} , I _B = 0.5 mA _{dc}) (I _C = 100 mA _{dc} , I _B = 5.0 mA _{dc})		V _{CE(sat)}	– –	0.2 0.6	V _{dc}
Base–Emitter On Voltage (I _C = 1.0 mA _{dc} , V _{CE} = 5.0 V _{dc})		V _{BE(on)}	0.56	0.66	V _{dc}

SMALL–SIGNAL CHARACTERISTICS

Current–Gain – Bandwidth Product (I _C = 1.0 mA _{dc} , V _{CE} = 5.0 V _{dc} , f = 100 MHz)		f _T	100	700	MHz
Output Capacitance (V _{CB} = 10 V _{dc} , I _E = 0, f = 1.0 MHz)		C _{obo}	–	3.0	pF
Input Capacitance (V _{EB} = 0.5 V _{dc} , I _C = 0, f = 1.0 MHz)		C _{ibo}	–	8.0	pF

Product parametric performance is indicated in the Electrical Characteristics for the listed test conditions, unless otherwise noted. Product performance may not be indicated by the Electrical Characteristics if operated under different conditions.

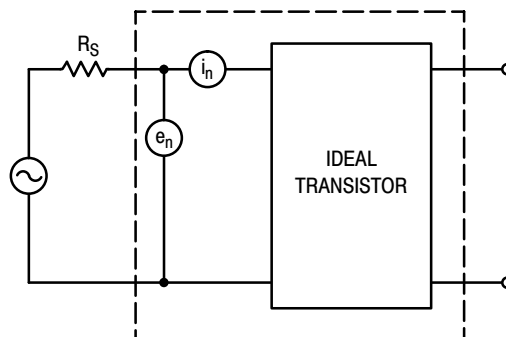

Figure 1. Transistor Noise Model

MMBT6428LT1G, MMBT6429LT1G, NSVMMBT6429LT1G

NOISE CHARACTERISTICS

($V_{CE} = 5.0 \text{ Vdc}$, $T_A = 25^\circ\text{C}$)

NOISE VOLTAGE

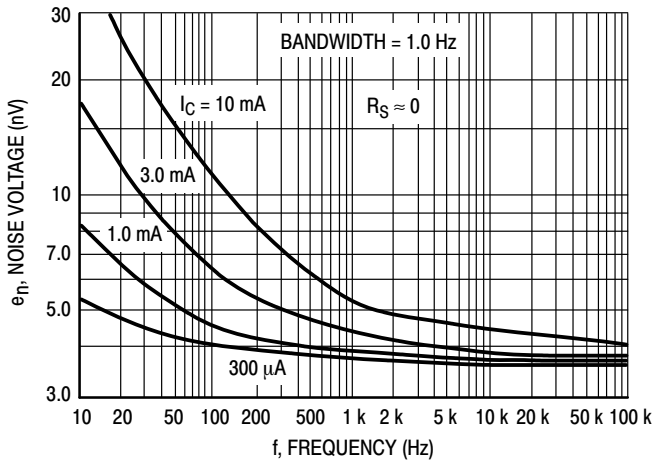

Figure 2. Effects of Frequency

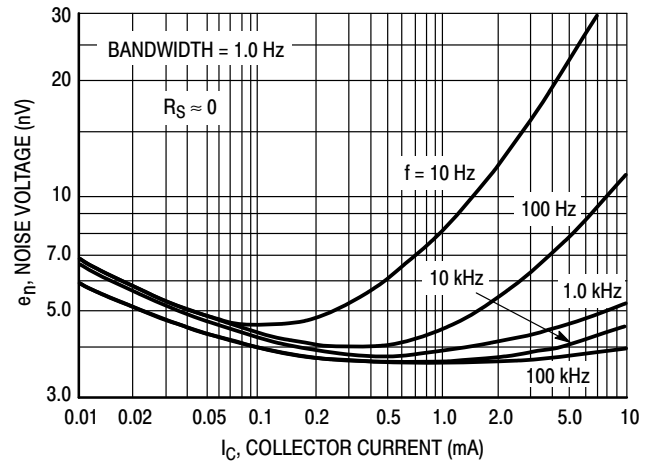

Figure 3. Effects of Collector Current

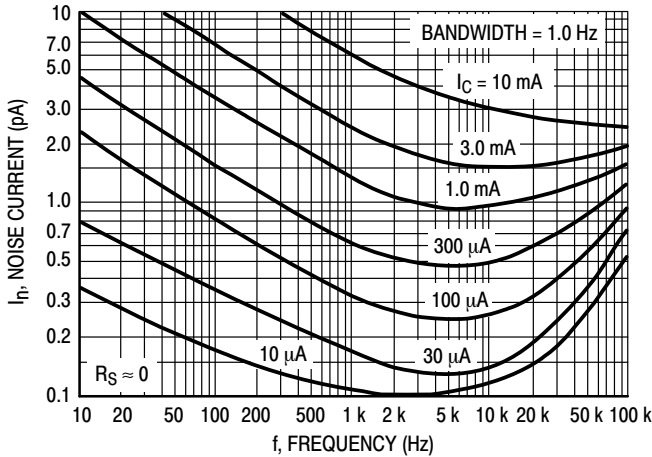

Figure 4. Noise Current

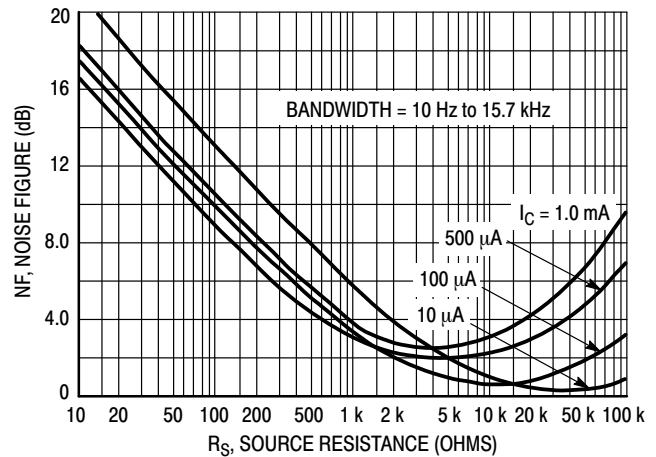

Figure 5. Wideband Noise Figure

100 Hz NOISE DATA

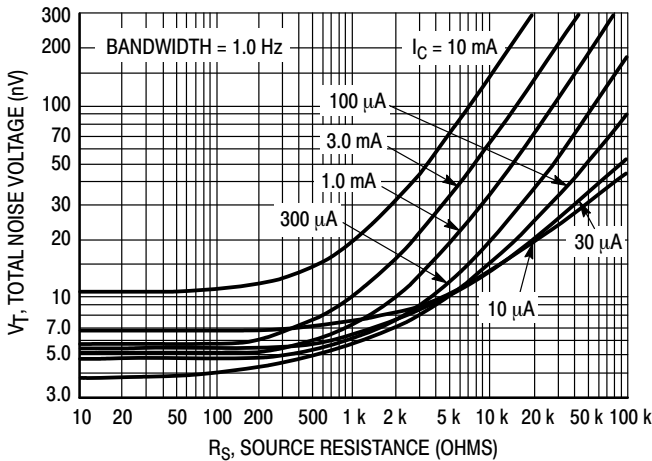

Figure 6. Total Noise Voltage

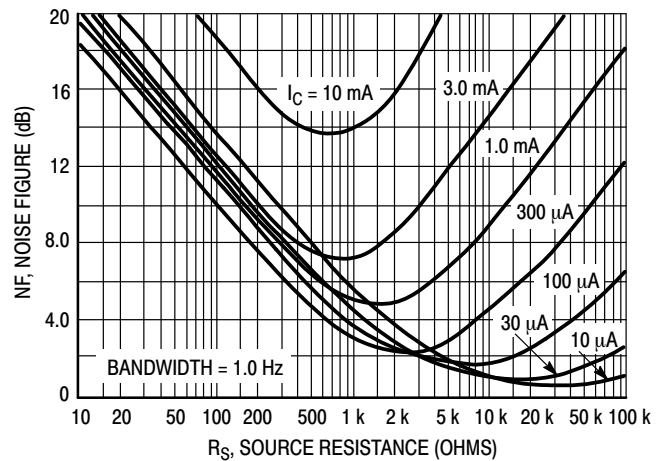

Figure 7. Noise Figure

MMBT6428LT1G, MMBT6429LT1G, NSVMMBT6429LT1G

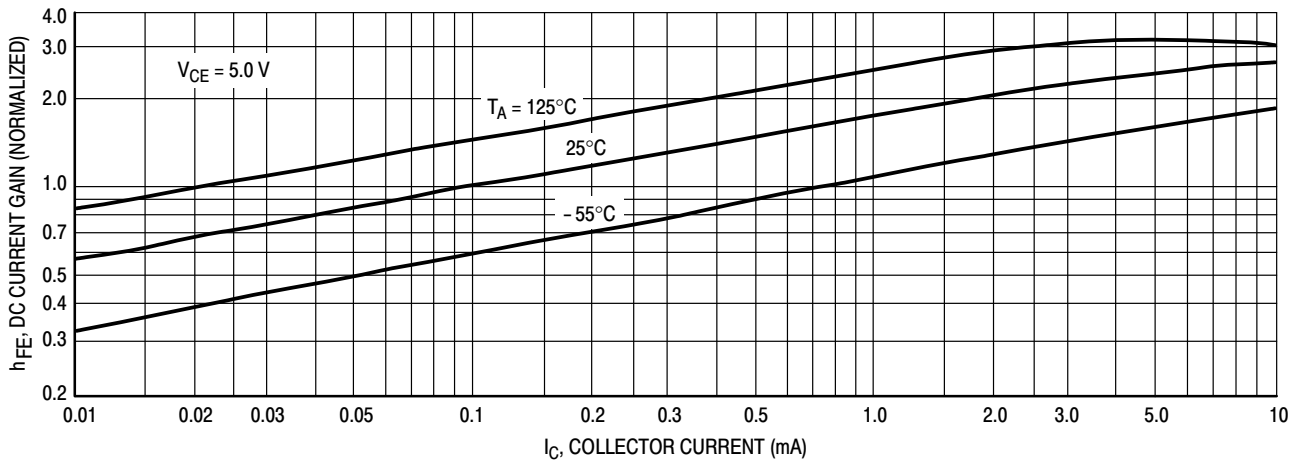

Figure 8. DC Current Gain

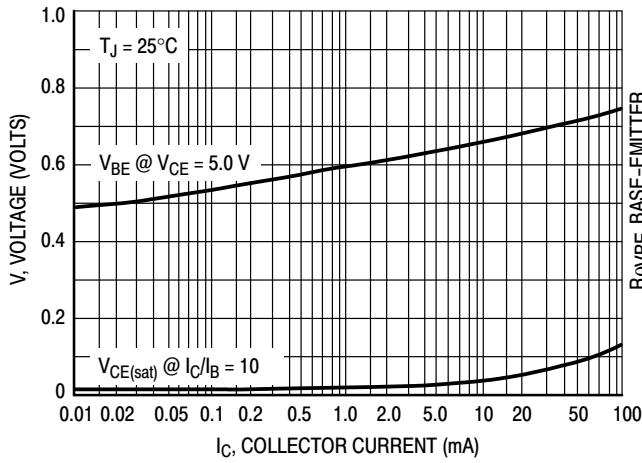

Figure 9. "On" Voltages

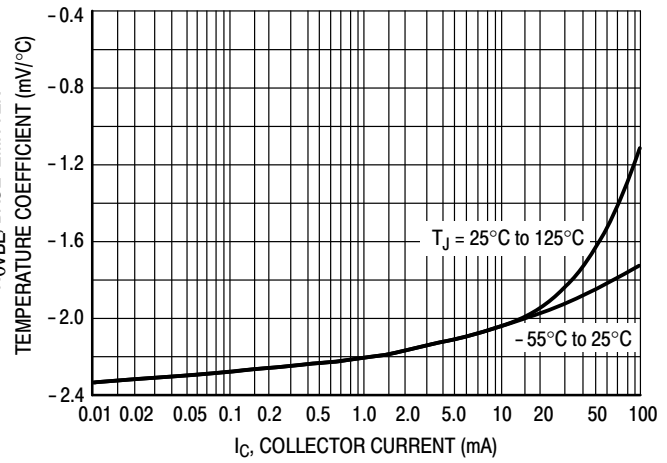

Figure 10. Temperature Coefficients

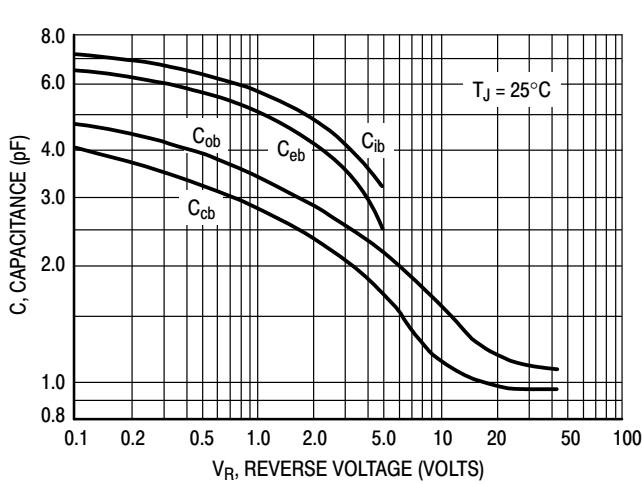

Figure 11. Capacitance

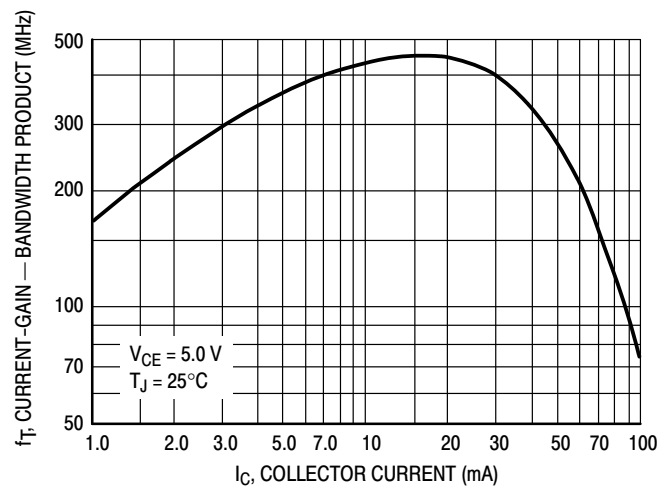

Figure 12. Current-Gain — Bandwidth Product

MECHANICAL CASE OUTLINE

PACKAGE DIMENSIONS

ON Semiconductor®



SOT-23 (TO-236) CASE 318-08 ISSUE AS

DATE 30 JAN 2018

SCALE 4:1



NOTES:

1. DIMENSIONING AND TOLERANCING PER ASME Y14.5M, 1994.
2. CONTROLLING DIMENSION: MILLIMETERS.
3. MAXIMUM LEAD THICKNESS INCLUDES LEAD FINISH. MINIMUM LEAD THICKNESS IS THE MINIMUM THICKNESS OF THE BASE MATERIAL.
4. DIMENSIONS D AND E DO NOT INCLUDE MOLD FLASH, PROTRUSIONS, OR GATE BURRS.

DIM	MILLIMETERS			INCHES		
	MIN	NOM	MAX	MIN	NOM	MAX
A	0.89	1.00	1.11	0.035	0.039	0.044
A1	0.01	0.06	0.10	0.000	0.002	0.004
b	0.37	0.44	0.50	0.015	0.017	0.020
c	0.08	0.14	0.20	0.003	0.006	0.008
D	2.80	2.90	3.04	0.110	0.114	0.120
E	1.20	1.30	1.40	0.047	0.051	0.055
e	1.78	1.90	2.04	0.070	0.075	0.080
L	0.30	0.43	0.55	0.012	0.017	0.022
L1	0.35	0.54	0.69	0.014	0.021	0.027
HE	2.10	2.40	2.64	0.083	0.094	0.104
T	0°	---	10°	0°	---	10°

RECOMMENDED SOLDERING FOOTPRINT



GENERIC MARKING DIAGRAM*

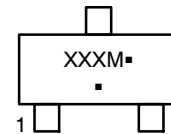

XXX = Specific Device Code
M = Date Code
▪ = Pb-Free Package

*This information is generic. Please refer to device data sheet for actual part marking. Pb-Free indicator, "G" or microdot "▪", may or may not be present.

STYLE 1 THRU 5:
CANCELLED

STYLE 6:
PIN 1. BASE
2. EMITTER
3. COLLECTOR

STYLE 7:
PIN 1. EMITTER
2. BASE
3. COLLECTOR

STYLE 8:
PIN 1. ANODE
2. NO CONNECTION
3. CATHODE

STYLE 9:
PIN 1. ANODE
2. ANODE
3. CATHODE

STYLE 10:
PIN 1. DRAIN
2. SOURCE
3. GATE

STYLE 11:
PIN 1. ANODE
2. CATHODE
3. CATHODE-ANODE

STYLE 12:
PIN 1. CATHODE
2. CATHODE
3. ANODE

STYLE 13:
PIN 1. SOURCE
2. DRAIN
3. GATE

STYLE 14:
PIN 1. CATHODE
2. GATE
3. ANODE

STYLE 15:
PIN 1. GATE
2. CATHODE
3. ANODE

STYLE 16:
PIN 1. ANODE
2. CATHODE
3. CATHODE

STYLE 17:
PIN 1. NO CONNECTION
2. ANODE
3. CATHODE

STYLE 18:
PIN 1. NO CONNECTION
2. CATHODE
3. ANODE

STYLE 19:
PIN 1. CATHODE
2. ANODE
3. CATHODE-ANODE

STYLE 20:
PIN 1. CATHODE
2. ANODE
3. GATE

STYLE 21:
PIN 1. GATE
2. SOURCE
3. DRAIN

STYLE 22:
PIN 1. RETURN
2. OUTPUT
3. INPUT

STYLE 23:
PIN 1. ANODE
2. ANODE
3. CATHODE

STYLE 24:
PIN 1. GATE
2. DRAIN
3. SOURCE

STYLE 25:
PIN 1. ANODE
2. CATHODE
3. GATE

STYLE 26:
PIN 1. CATHODE
2. ANODE
3. NO CONNECTION

STYLE 27:
PIN 1. CATHODE
2. CATHODE
3. CATHODE

STYLE 28:
PIN 1. ANODE
2. ANODE
3. ANODE

DOCUMENT NUMBER:	98ASB42226B	Electronic versions are uncontrolled except when accessed directly from the Document Repository. Printed versions are uncontrolled except when stamped "CONTROLLED COPY" in red.
DESCRIPTION:	SOT-23 (TO-236)	PAGE 1 OF 1

ON Semiconductor and are trademarks of Semiconductor Components Industries, LLC dba ON Semiconductor or its subsidiaries in the United States and/or other countries. ON Semiconductor reserves the right to make changes without further notice to any products herein. ON Semiconductor makes no warranty, representation or guarantee regarding the suitability of its products for any particular purpose, nor does ON Semiconductor assume any liability arising out of the application or use of any product or circuit, and specifically disclaims any and all liability, including without limitation special, consequential or incidental damages. ON Semiconductor does not convey any license under its patent rights nor the rights of others.

onsemi, **Onsemi**, and other names, marks, and brands are registered and/or common law trademarks of Semiconductor Components Industries, LLC dba "**onsemi**" or its affiliates and/or subsidiaries in the United States and/or other countries. **onsemi** owns the rights to a number of patents, trademarks, copyrights, trade secrets, and other intellectual property. A listing of **onsemi**'s product/patent coverage may be accessed at www.onsemi.com/site/pdf/Patent-Marking.pdf. **onsemi** reserves the right to make changes at any time to any products or information herein, without notice. The information herein is provided "as-is" and **onsemi** makes no warranty, representation or guarantee regarding the accuracy of the information, product features, availability, functionality, or suitability of its products for any particular purpose, nor does **onsemi** assume any liability arising out of the application or use of any product or circuit, and specifically disclaims any and all liability, including without limitation special, consequential or incidental damages. Buyer is responsible for its products and applications using **onsemi** products, including compliance with all laws, regulations and safety requirements or standards, regardless of any support or applications information provided by **onsemi**. "Typical" parameters which may be provided in **onsemi** data sheets and/or specifications can and do vary in different applications and actual performance may vary over time. All operating parameters, including "Typicals" must be validated for each customer application by customer's technical experts. **onsemi** does not convey any license under any of its intellectual property rights nor the rights of others. **onsemi** products are not designed, intended, or authorized for use as a critical component in life support systems or any FDA Class 3 medical devices or medical devices with a same or similar classification in a foreign jurisdiction or any devices intended for implantation in the human body. Should Buyer purchase or use **onsemi** products for any such unintended or unauthorized application, Buyer shall indemnify and hold **onsemi** and its officers, employees, subsidiaries, affiliates, and distributors harmless against all claims, costs, damages, and expenses, and reasonable attorney fees arising out of, directly or indirectly, any claim of personal injury or death associated with such unintended or unauthorized use, even if such claim alleges that **onsemi** was negligent regarding the design or manufacture of the part. **onsemi** is an Equal Opportunity/Affirmative Action Employer. This literature is subject to all applicable copyright laws and is not for resale in any manner.

PUBLICATION ORDERING INFORMATION

LITERATURE FULFILLMENT:

Email Requests to: orderlit@onsemi.com

onsemi Website: www.onsemi.com

TECHNICAL SUPPORT

North American Technical Support:

Voice Mail: 1 800-282-9855 Toll Free USA/Canada

Phone: 011 421 33 790 2910

Europe, Middle East and Africa Technical Support:

Phone: 00421 33 790 2910

For additional information, please contact your local Sales Representative