



Inductors for Decoupling Circuits

Wound Ferrite

NLC Series

NLC565050 Type

NLC565050 5650 [2220 inch]*

* Dimensions Code JIS[EIA]

Caution

**The products in this catalog will be or have been
stopped production**

Discontinue Issue Date	May.21, 2015
Last Purchase Order Date	Dec.22, 2016
Last Shipment Date	Jan.30, 2017

Please refer to our Web site about replacement information.

REMINDERS FOR USING THESE PRODUCTS

Before using these products, be sure to request the delivery specifications.

SAFETY REMINDERS

Please pay sufficient attention to the warnings for safe designing when using these products.

REMINDERS

- The storage period is less than 6 months. Be sure to follow the storage conditions (Temperature: 5 to 40°C, Humidity: 10 to 75% RH or less).
If the storage period elapses, the soldering of the terminal electrodes may deteriorate.
- Do not use or store in locations where there are conditions such as gas corrosion (salt, acid, alkali, etc.).
- Before soldering, be sure to preheat components.
The preheating temperature should be set so that the temperature difference between the solder temperature and chip temperature does not exceed 150°C.
- Soldering corrections after mounting should be within the range of the conditions determined in the specifications.
If overheated, a short circuit, performance deterioration, or lifespan shortening may occur.
- When embedding a printed circuit board where a chip is mounted to a set, be sure that residual stress is not given to the chip due to the overall distortion of the printed circuit board and partial distortion such as at screw tightening portions.
- Self heating (temperature increase) occurs when the power is turned ON, so the tolerance should be sufficient for the set thermal design.
- Carefully lay out the coil for the circuit board design of the non-magnetic shield type.
A malfunction may occur due to magnetic interference.
- Use a wrist band to discharge static electricity in your body through the grounding wire.
- Do not expose the products to magnets or magnetic fields.
- Do not use for a purpose outside of the contents regulated in the delivery specifications.
- The products listed on this catalog are intended for use in general electronic equipment (AV equipment, telecommunications equipment, home appliances, amusement equipment, computer equipment, personal equipment, office equipment, measurement equipment, industrial robots) under a normal operation and use condition.
The products are not designed or warranted to meet the requirements of the applications listed below, whose performance and/or quality require a more stringent level of safety or reliability, or whose failure, malfunction or trouble could cause serious damage to society, person or property.
If you intend to use the products in the applications listed below or if you have special requirements exceeding the range or conditions set forth in the each catalog, please contact us.

- (1) Aerospace/Aviation equipment
- (2) Transportation equipment (cars, electric trains, ships, etc.)
- (3) Medical equipment
- (4) Power-generation control equipment
- (5) Atomic energy-related equipment
- (6) Seabed equipment
- (7) Transportation control equipment

- (8) Public information-processing equipment
- (9) Military equipment
- (10) Electric heating apparatus, burning equipment
- (11) Disaster prevention/crime prevention equipment
- (12) Safety equipment
- (13) Other applications that are not considered general-purpose applications

When designing your equipment even for general-purpose applications, you are kindly requested to take into consideration securing protection circuit/device or providing backup circuits in your equipment.

Inductors for Decoupling Circuits

Product compatible with RoHS directive
Compatible with lead-free solders

Wound Ferrite

Overview of NLC565050 Type

FEATURES

- Resin mold type wound inductor for decoupling circuits.
- E-12 Series, wide lineup compatible with K ($\pm 10\%$) tolerance allows for various usages.

APPLICATION

Smart meters, AV equipment, xDSL, electronic devices for communications infrastructure such as mobile base stations, industrial equipment, other

PART NUMBER CONSTRUCTION

NLC	565050	T	-	1R0	K	-	PF	
Series name	LxWxH Dimensions (mm)	Packaging style		Inductance (μH)		Inductance tolerance		Lead-free compatible
565050	5.6x5.0x5.0	T	Taping	1R0	1	K	$\pm 10\%$	
				100	10			
				101	100			
				102	1000			

OPERATING TEMPERATURE RANGE, PACKAGE QUANTITY, PRODUCT WEIGHT

Type	Temperature range		Package quantity (pieces/reel)	Individual weight (mg)
	Operating temperature* (°C)	Storage temperature** (°C)		
NLC565050	-40 to +105	-40 to +105	400	380

* Operating temperature range includes self-temperature rise.

** The Storage temperature range is for after the circuit board is mounted.

○ RoHS Directive Compliant Product: See the following for more details related to RoHS Directive compliant products. <http://product.tdk.com/en/environment/rohs/>

⚠ Please be sure to request delivery specifications that provide further details on the features and specifications of the products for proper and safe use. Please note that the contents may change without any prior notice due to reasons such as upgrading.

NLC565050 Type

RECOMMENDED REFLOW PROFILE

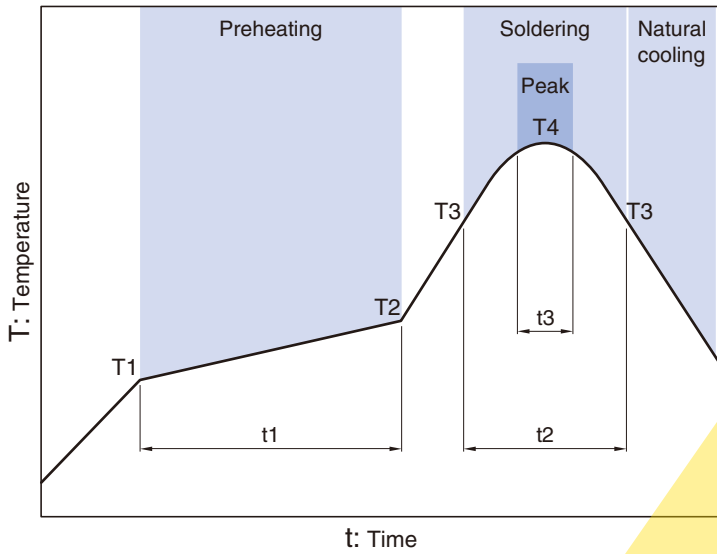

Preheating			Soldering		Peak	
Temp.	Temp.	Time	Temp.	Time	Temp.	Time
T1	T2	t1	T3	t2	T4	t3
150°C	180°C	90 to 120s	230°C	40s	255°C	10s max.

The products will be or have been stopped production

 Please be sure to request delivery specifications that provide further details on the features and specifications of the products for proper and safe use. Please note that the contents may change without any prior notice due to reasons such as upgrading.

NLC565050 Type

SHAPE & DIMENSIONS

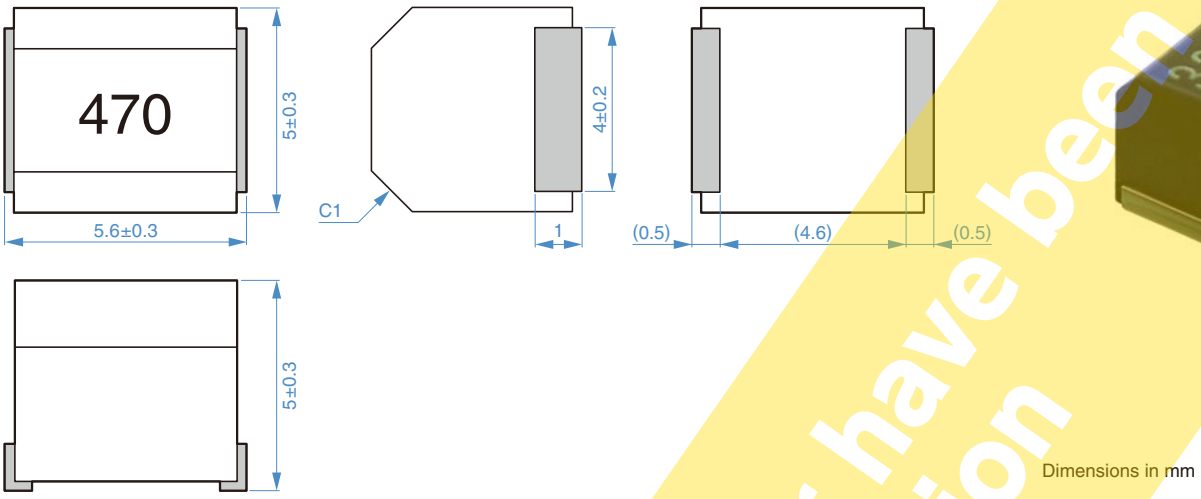

RECOMMENDED LAND PATTERN

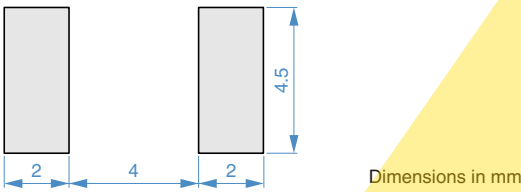

The products will be or have been stopped production

 Please be sure to request delivery specifications that provide further details on the features and specifications of the products for proper and safe use. Please note that the contents may change without any prior notice due to reasons such as upgrading.

NLC565050 Type

ELECTRICAL CHARACTERISTICS

CHARACTERISTICS SPECIFICATION TABLE

L	Q	L, Q measuring frequency	DC resistance	Rated current*	Part No.	
(μ H)	Tolerance	min.	(MHz)	(Ω)max.	(mA)max.	
1	$\pm 10\%$	10	7.96	0.03	1800	NLC565050T-1R0K-PF
1.2	$\pm 10\%$	10	7.96	0.035	1700	NLC565050T-1R2K-PF
1.5	$\pm 10\%$	10	7.96	0.04	1600	NLC565050T-1R5K-PF
1.8	$\pm 10\%$	10	7.96	0.05	1400	NLC565050T-1R8K-PF
2.2	$\pm 10\%$	10	7.96	0.06	1300	NLC565050T-2R2K-PF
2.7	$\pm 10\%$	10	7.96	0.07	1200	NLC565050T-2R7K-PF
3.3	$\pm 10\%$	10	7.96	0.08	1120	NLC565050T-3R3K-PF
3.9	$\pm 10\%$	10	7.96	0.09	1050	NLC565050T-3R9K-PF
4.7	$\pm 10\%$	10	7.96	0.11	950	NLC565050T-4R7K-PF
5.6	$\pm 10\%$	10	7.96	0.13	880	NLC565050T-5R6K-PF
6.8	$\pm 10\%$	10	7.96	0.15	810	NLC565050T-6R8K-PF
8.2	$\pm 10\%$	10	7.96	0.18	750	NLC565050T-8R2K-PF
10	$\pm 10\%$	10	2.52	0.21	690	NLC565050T-100K-PF
12	$\pm 10\%$	10	2.52	0.25	630	NLC565050T-120K-PF
15	$\pm 10\%$	10	2.52	0.3	580	NLC565050T-150K-PF
18	$\pm 10\%$	10	2.52	0.36	530	NLC565050T-180K-PF
22	$\pm 10\%$	10	2.52	0.43	480	NLC565050T-220K-PF
27	$\pm 10\%$	10	2.52	0.52	440	NLC565050T-270K-PF
33	$\pm 10\%$	10	2.52	0.62	400	NLC565050T-330K-PF
39	$\pm 10\%$	10	2.52	0.72	370	NLC565050T-390K-PF
47	$\pm 10\%$	10	2.52	0.85	340	NLC565050T-470K-PF
56	$\pm 10\%$	10	2.52	1	310	NLC565050T-560K-PF
68	$\pm 10\%$	10	2.52	1.2	290	NLC565050T-680K-PF
82	$\pm 10\%$	10	2.52	1.4	270	NLC565050T-820K-PF
100	$\pm 10\%$	20	0.796	1.6	250	NLC565050T-101K-PF
120	$\pm 10\%$	20	0.796	1.9	230	NLC565050T-121K-PF
150	$\pm 10\%$	20	0.796	2.2	210	NLC565050T-151K-PF
180	$\pm 10\%$	20	0.796	2.8	190	NLC565050T-181K-PF
220	$\pm 10\%$	20	0.796	3.4	170	NLC565050T-221K-PF
270	$\pm 10\%$	20	0.796	4.2	155	NLC565050T-271K-PF
330	$\pm 10\%$	20	0.796	4.9	140	NLC565050T-331K-PF
390	$\pm 10\%$	20	0.796	5.8	130	NLC565050T-391K-PF
470	$\pm 10\%$	20	0.796	7	120	NLC565050T-471K-PF
560	$\pm 10\%$	20	0.796	8.5	110	NLC565050T-561K-PF
680	$\pm 10\%$	20	0.796	10	100	NLC565050T-681K-PF
820	$\pm 10\%$	20	0.796	13	90	NLC565050T-821K-PF
1000	$\pm 10\%$	20	0.252	15	85	NLC565050T-102K-PF

* Rated current: smaller value of either I_{dc1} or I_{dc2} .

I_{dc1} : When based on the inductance change rate (10% below the initial L value)

I_{dc2} : When based on the temperature increase (Temperature increase of 20°C by self heating)

Measurement equipment

Measurement item	Product No.	Manufacturer
L, Q	4194A+16085A+16093B	Agilent Technologies
DC resistance	VP-2941A	Panasonic

* Equivalent measurement equipment may be used.

NLC565050 Type

ELECTRICAL CHARACTERISTICS

FREQUENCY CHARACTERISTICS GRAPH

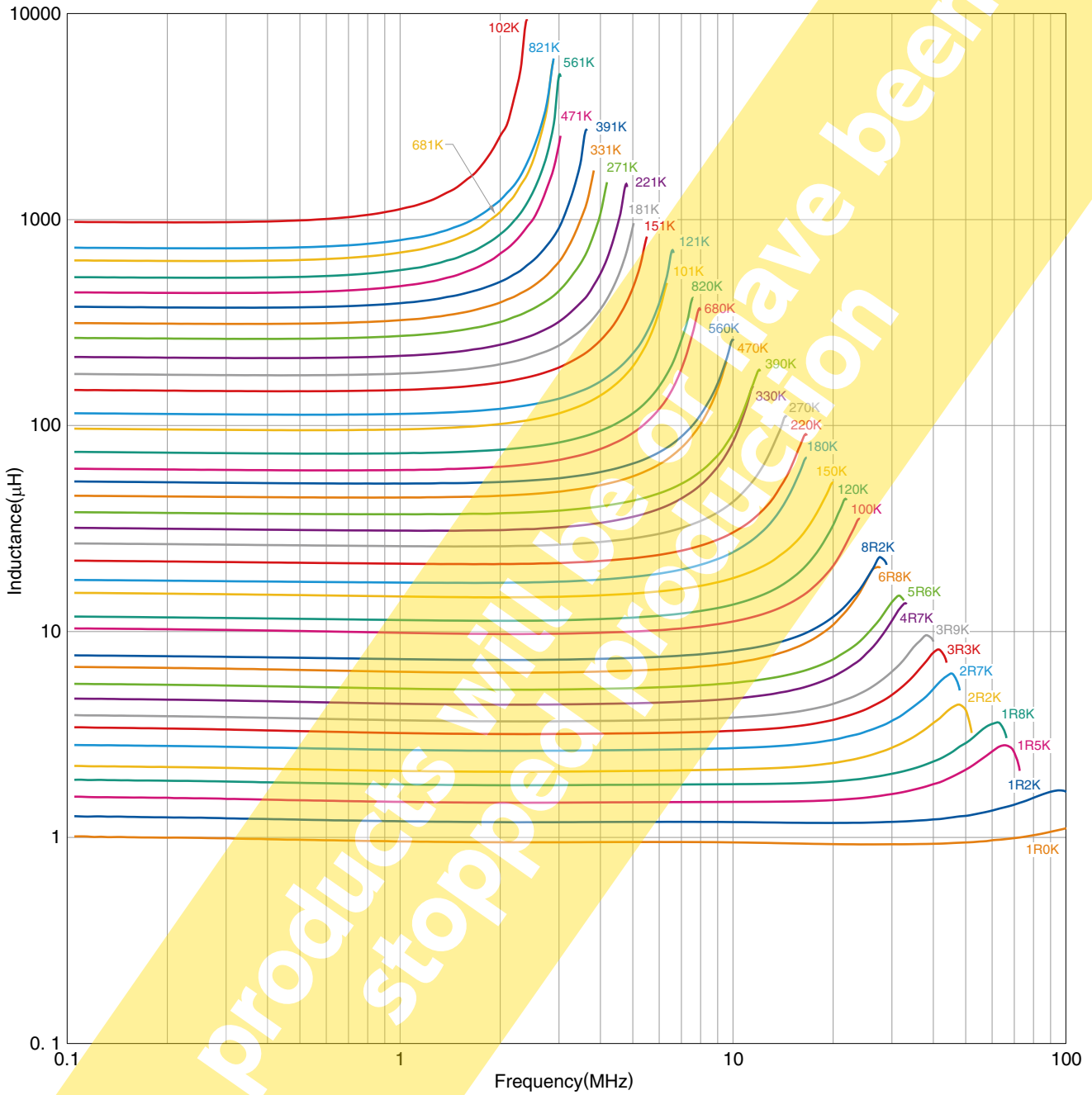

○ Measurement equipment

Product No.	Manufacturer
4294A	Agilent Technologies

* Equivalent measurement equipment may be used.

 Please be sure to request delivery specifications that provide further details on the features and specifications of the products for proper and safe use. Please note that the contents may change without any prior notice due to reasons such as upgrading.

NLC565050 Type

ELECTRICAL CHARACTERISTICS

INDUCTANCE VS. DC BIAS CHARACTERISTICS GRAPH

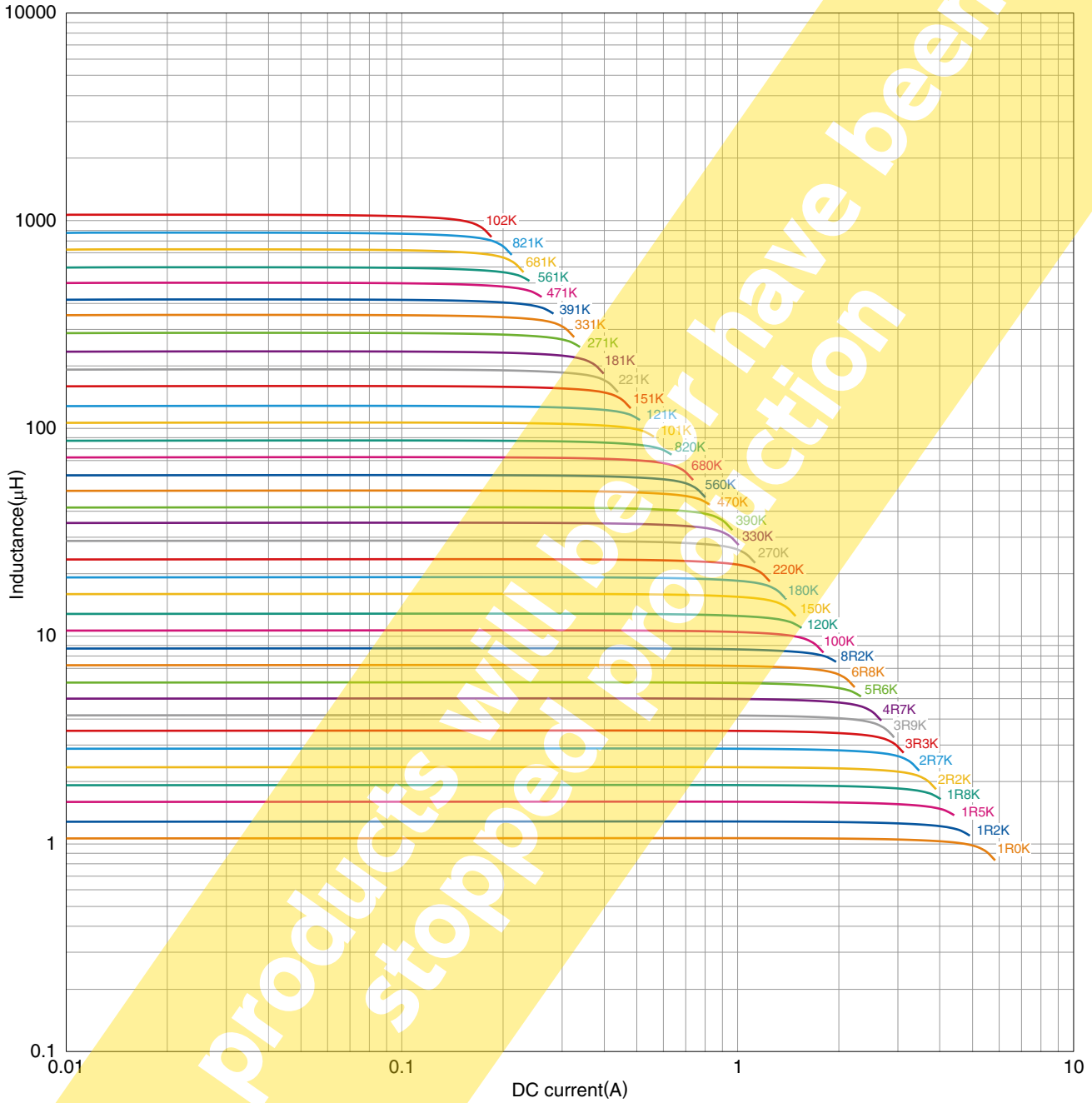

○ Measurement equipment

Product No.	Manufacturer
4285A+42841A+42842C	Agilent Technologies

* Equivalent measurement equipment may be used.

 Please be sure to request delivery specifications that provide further details on the features and specifications of the products for proper and safe use. Please note that the contents may change without any prior notice due to reasons such as upgrading.

NLC565050 Type

ELECTRICAL CHARACTERISTICS

IMPEDANCE FREQUENCY CHARACTERISTICS GRAPH

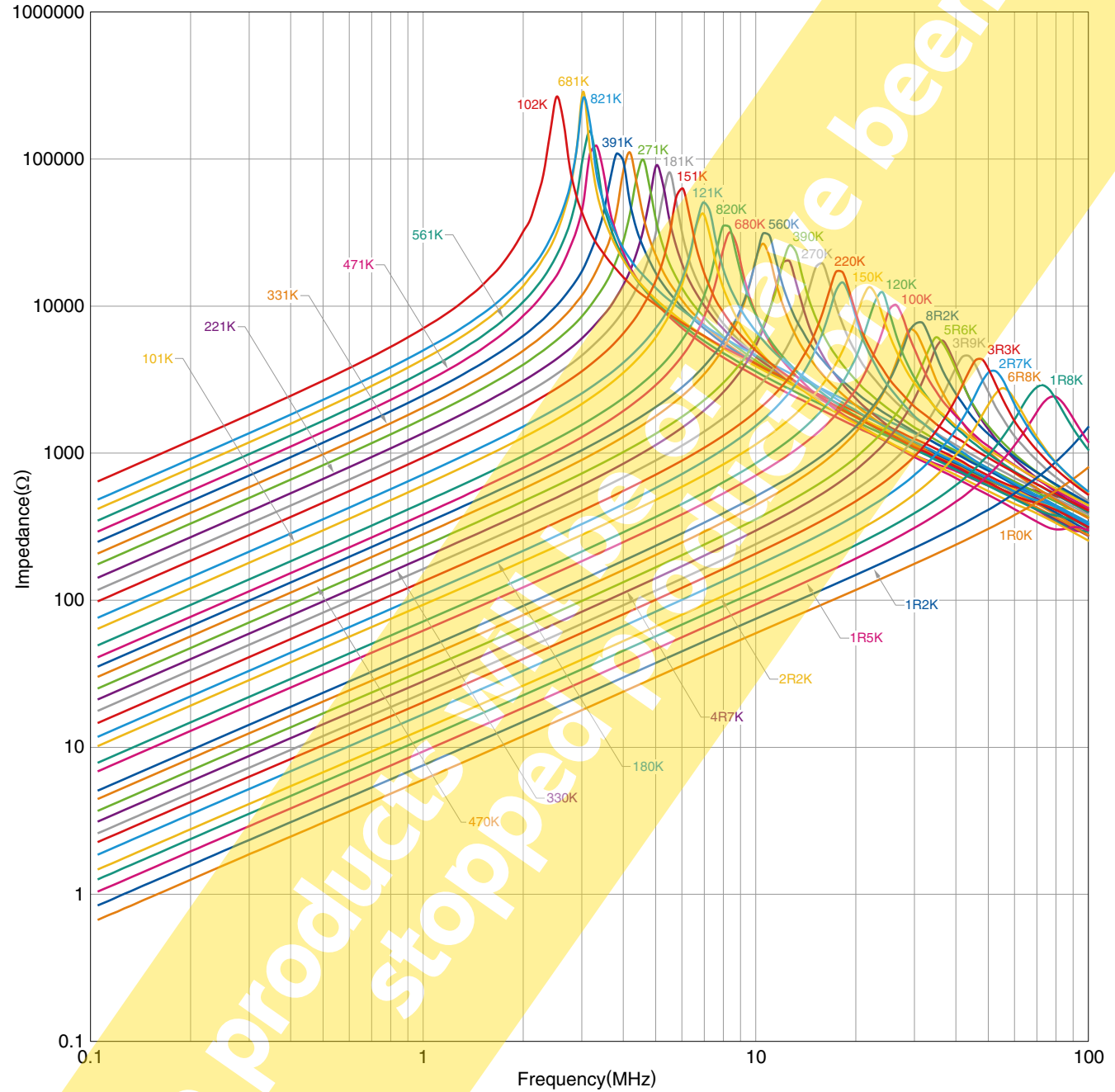

○ Measurement equipment

Product No.	Manufacturer
4294A	Agilent Technologies

* Equivalent measurement equipment may be used.

 Please be sure to request delivery specifications that provide further details on the features and specifications of the products for proper and safe use. Please note that the contents may change without any prior notice due to reasons such as upgrading.

NLC565050 Type

PACKAGING STYLE

REEL DIMENSIONS

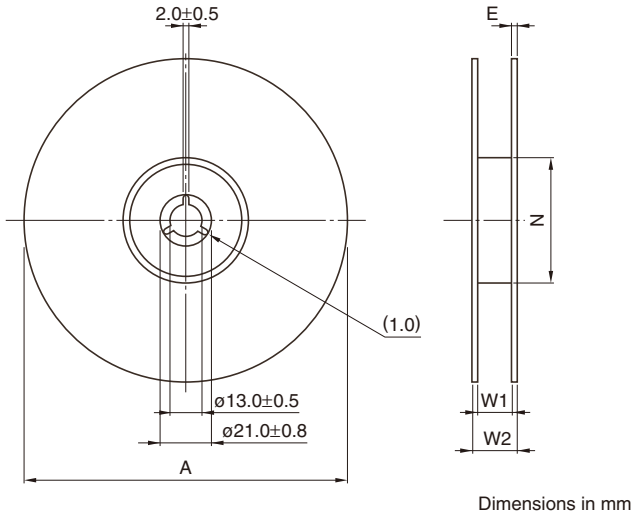

Type	A	W1	W2	N	E
NLC565050	ø180	13	17	ø60	0.5

* These values are typical values.

TAPE DIMENSIONS

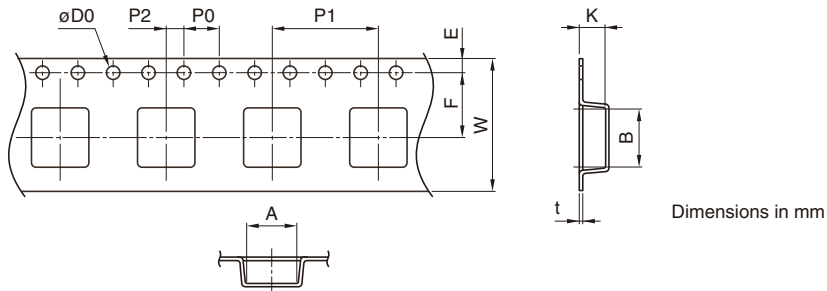

Type	A	B	øD0	E	F	P0	P1	P2	W	K	t
NLC565050	5.4	5.8	1.5+0.1/-0	1.75±0.1	5.50±0.05	4.00±0.10	8.00±0.10	2.00±0.05	12.0±0.30	5.4	0.4

 Please be sure to request delivery specifications that provide further details on the features and specifications of the products for proper and safe use. Please note that the contents may change without any prior notice due to reasons such as upgrading.