

Important notice

Dear Customer,

On 7 February 2017 the former NXP Standard Product business became a new company with the tradename **Nexperia**. Nexperia is an industry leading supplier of Discrete, Logic and PowerMOS semiconductors with its focus on the automotive, industrial, computing, consumer and wearable application markets

In data sheets and application notes which still contain NXP or Philips Semiconductors references, use the references to Nexperia, as shown below.

Instead of <http://www.nxp.com>, <http://www.philips.com/> or <http://www.semiconductors.philips.com/>, use <http://www.nexperia.com>

Instead of sales.addresses@www.nxp.com or sales.addresses@www.semiconductors.philips.com, use salesaddresses@nexperia.com (email)

Replace the copyright notice at the bottom of each page or elsewhere in the document, depending on the version, as shown below:

- © NXP N.V. (year). All rights reserved or © Koninklijke Philips Electronics N.V. (year). All rights reserved

Should be replaced with:

- © **Nexperia B.V. (year). All rights reserved.**

If you have any questions related to the data sheet, please contact our nearest sales office via e-mail or telephone (details via salesaddresses@nexperia.com). Thank you for your cooperation and understanding,

Kind regards,

Team Nexperia

DATA SHEET

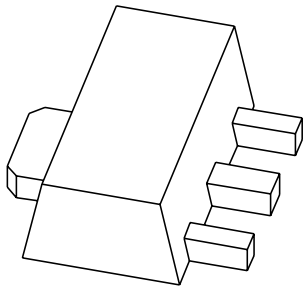

BZV49 series Voltage regulator diodes

Product data sheet
Supersedes data of 1999 May 11

2005 Feb 03

Voltage regulator diodes

BZV49 series

FEATURES

- Total power dissipation: max. 1 W
- Tolerance series: approx. $\pm 5\%$
- Working voltage range: nom. 2.4 to 75 V (E24 range)
- Non-repetitive peak reverse power dissipation: max. 40 W.

APPLICATIONS

- General regulation functions.

DESCRIPTION

Medium-power voltage regulator diodes in a SOT89 plastic SMD package.

The diodes are available in the normalized E24 approx. $\pm 5\%$ tolerance range. The series consists of 37 types with nominal working voltages from 2.4 to 75 V (BZV49-C2V4 to BZV49-C75).

PINNING

PIN	DESCRIPTION
1	anode
2	cathode
3	anode

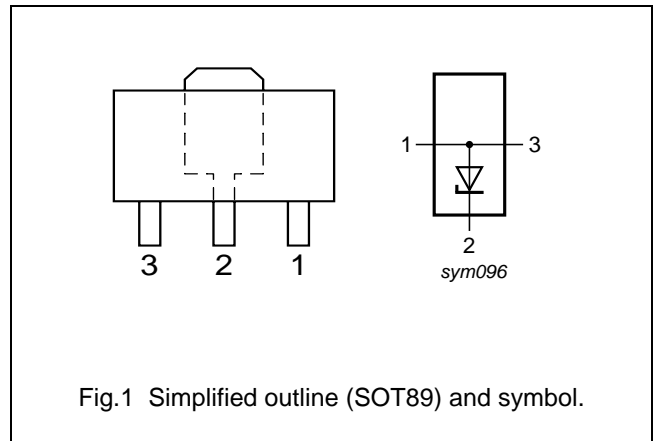

Fig.1 Simplified outline (SOT89) and symbol.

ORDERING INFORMATION

TYPE NUMBER	PACKAGE		
	NAME	DESCRIPTION	VERSION
BZV49-C2V4 to BZV49-C75 note 1	SC-62	plastic surface mounted package; collector pad for good heat transfer; 3 leads	SOT89

Note

1. The series consists of 37 types with nominal working voltages from 2.4 to 75 V (E24 range).

MARKING

TYPE NUMBER	MARKING CODE	TYPE NUMBER	MARKING CODE	TYPE NUMBER	MARKING CODE	TYPE NUMBER	MARKING CODE
BZV49-C2V4	2Y4	BZV49-C6V2	6Y2	BZV49-C16	16Y	BZV49-C43	43Y
BZV49-C2V7	2Y7	BZV49-C6V8	6Y8	BZV49-C18	18Y	BZV49-C47	47Y
BZV49-C3V0	3Y0	BZV49-C7V5	7Y5	BZV49-C20	20Y	BZV49-C51	51Y
BZV49-C3Y3	3Y3	BZV49-C8V2	8Y2	BZV49-C22	22Y	BZV49-C56	56Y
BZV49-C3V6	3Y6	BZV49-C9V1	9Y1	BZV49-C24	24Y	BZV49-C62	62Y
BZV49-C3V9	3Y9	BZV49-C10	10Y	BZV49-C27	27Y	BZV49-C68	68Y
BZV49-C4V3	4Y3	BZV49-C11	11Y	BZV49-C30	30Y	BZV49-C75	75Y
BZV49-C4V7	4Y7	BZV49-C12	12Y	BZV49-C33	33Y	–	–
BZV49-C5V1	5Y1	BZV49-C13	13Y	BZV49-C36	36Y	–	–
BZV49-C5V6	5Y6	BZV49-C15	15Y	BZV49-C39	39Y	–	–

Voltage regulator diodes

BZV49 series

LIMITING VALUES

In accordance with the Absolute Maximum Rating System (IEC 60134).

SYMBOL	PARAMETER	CONDITIONS	MIN.	MAX.	UNIT
I_F	continuous forward current		–	250	mA
I_{ZSM}	non-repetitive peak reverse current	$t_p = 100 \mu\text{s}$; square wave; $T_j = 25 \text{ }^\circ\text{C}$ prior to surge	see Table "Per type"		
P_{tot}	total power dissipation	$T_{amb} = 25 \text{ }^\circ\text{C}$; note 1	–	1	W
P_{ZSM}	non-repetitive peak reverse power dissipation	$t_p = 100 \mu\text{s}$; square wave; $T_j = 25 \text{ }^\circ\text{C}$ prior to surge; see Fig.2	–	40	W
T_{stg}	storage temperature		–65	+150	$^\circ\text{C}$
T_j	junction temperature		–	150	$^\circ\text{C}$

Note

1. Device mounted on a ceramic substrate; area = 2.5 cm²; thickness = 0.7 mm.

ELECTRICAL CHARACTERISTICS**Total series**

$T_{amb} = 25 \text{ }^\circ\text{C}$ unless otherwise specified.

SYMBOL	PARAMETER	CONDITIONS	MAX.	UNIT
V_F	forward voltage	$I_F = 50 \text{ mA}$; see Fig.3	1	V

Voltage regulator diodes

BZV49 series

Per type

 $T_j = 25\text{ °C}$ unless otherwise specified.

BZV49- CXXX	WORKING VOLTAGE V_Z (V) at I_{Ztest}		DIFFERENTIAL RESISTANCE r_{dif} (Ω) at I_{Ztest}		TEMP. COEFF. S_Z (mV/K) at I_{Ztest} see Figs 4 and 5			TEST CURRENT I_{Ztest} (mA)	DIODE CAP. C_d (pF) at $f = 1$ MHz; at $V_R = 0$ V	REVERSE CURRENT at REVERSE VOLTAGE		NON-REPETITIVE PEAK REVERSE CURRENT I_{ZSM} (A) at $t_p = 100\ \mu\text{s}$; $T_{amb} = 25\text{ °C}$
	MIN.	MAX.	TYP.	MAX.	MIN.	TYP.	MAX.			I_R (μA)	V_R	
										MAX.	(V)	
2V4	2.2	2.6	70	100	-3.5	-1.6	0	5	450	50	1.0	6.0
2V7	2.5	2.9	75	100	-3.5	-2.0	0	5	450	20	1.0	6.0
3V0	2.8	3.2	80	95	-3.5	-2.1	0	5	450	10	1.0	6.0
3V3	3.1	3.5	85	95	-3.5	-2.4	0	5	450	5	1.0	6.0
3V6	3.4	3.8	85	90	-3.5	-2.4	0	5	450	5	1.0	6.0
3V9	3.7	4.1	85	90	-3.5	-2.5	0	5	450	3	1.0	6.0
4V3	4.0	4.6	80	90	-3.5	-2.5	0	5	450	3	1.0	6.0
4V7	4.4	5.0	50	80	-3.5	-1.4	+0.2	5	300	3	2.0	6.0
5V1	4.8	5.4	40	60	-2.7	-0.8	+1.2	5	300	2	2.0	6.0
5V6	5.2	6.0	15	40	-2.0	+1.2	+2.5	5	300	1	2.0	6.0
6V2	5.8	6.6	6	10	0.4	2.3	3.7	5	200	3	4.0	6.0
6V8	6.4	7.2	6	15	1.2	3.0	4.5	5	200	2	4.0	6.0
7V5	7.0	7.9	6	15	2.5	4.0	5.3	5	150	1	5.0	4.0
8V2	7.7	8.7	6	15	3.2	4.6	6.2	5	150	0.7	5.0	4.0
9V1	8.5	9.6	6	15	3.8	5.5	7.0	5	150	0.5	6.0	3.0
10	9.4	10.6	8	20	4.5	6.4	8.0	5	90	0.2	7.0	3.0
11	10.4	11.6	10	20	5.4	7.4	9.0	5	85	0.1	8.0	2.5
12	11.4	12.7	10	25	6.0	8.4	10.0	5	85	0.1	8.0	2.5
13	12.4	14.1	10	30	7.0	9.4	11.0	5	80	0.1	8.0	2.5
15	13.8	15.6	10	30	9.2	11.4	13.0	5	75	0.05	10.5	2.0
16	15.3	17.1	10	40	10.4	12.4	14.0	5	75	0.05	11.2	1.5
18	16.8	19.1	10	45	12.4	14.4	16.0	5	70	0.05	12.6	1.5
20	18.8	21.2	15	55	14.4	16.4	18.0	5	60	0.05	14.0	1.5
22	20.8	23.3	20	55	16.4	18.4	20.0	5	60	0.05	15.4	1.25
24	22.8	25.6	25	70	18.4	20.4	22.0	5	55	0.05	16.8	1.25

Voltage regulator diodes

BZV49 series

BZV49- CXXX	WORKING VOLTAGE V_Z (V) at I_{Ztest}		DIFFERENTIAL RESISTANCE r_{dif} (Ω) at I_{Ztest}		TEMP. COEFF. S_Z (mV/K) at I_{Ztest} see Figs 4 and 5			TEST CURRENT I_{Ztest} (mA)	DIODE CAP. C_d (pF) at $f = 1$ MHz; at $V_R = 0$ V	REVERSE CURRENT at REVERSE VOLTAGE		NON-REPETITIVE PEAK REVERSE CURRENT I_{ZSM} (A) at $t_p = 100 \mu s$; $T_{amb} = 25^\circ C$
	MIN.	MAX.	TYP.	MAX.	MIN.	TYP.	MAX.			I_R (μA)	V_R	
										MAX.	(V)	
27	25.1	28.9	25	80	21.4	23.4	25.3	2	50	0.05	18.9	1.0
30	28.0	32.0	30	80	24.4	26.6	29.4	2	50	0.05	21.0	1.0
33	31.0	35.0	35	80	27.4	29.7	33.4	2	45	0.05	23.1	0.9
36	34.0	38.0	35	90	30.4	33.0	37.4	2	45	0.05	25.2	0.8
39	37.0	41.0	40	130	33.4	36.4	41.2	2	45	0.05	27.3	0.7
43	40.0	46.0	45	150	37.6	41.2	46.6	2	40	0.05	30.1	0.6
47	44.0	50.0	50	170	42.0	46.1	51.8	2	40	0.05	32.9	0.5
51	48.0	54.0	60	180	46.6	51.0	57.2	2	40	0.05	35.7	0.4
56	52.0	60.0	70	200	52.2	57.0	63.8	2	40	0.05	39.2	0.3
62	58.0	66.0	80	215	58.8	64.4	71.6	2	35	0.05	43.4	0.3
68	64.0	72.0	90	240	65.6	71.7	79.8	2	35	0.05	47.6	0.25
75	70.0	79.0	95	255	73.4	80.2	88.6	2	35	0.05	52.5	0.2

Voltage regulator diodes

BZV49 series

THERMAL CHARACTERISTICS

SYMBOL	PARAMETER	CONDITIONS	VALUE	UNIT
$R_{th(j-tp)}$	thermal resistance from junction to tie-point		15	K/W
$R_{th(j-a)}$	thermal resistance from junction to ambient	note 1	125	K/W

Note

1. Device mounted on a ceramic substrate; area = 2.5 cm²; thickness = 0.7 mm.

GRAPHICAL DATA

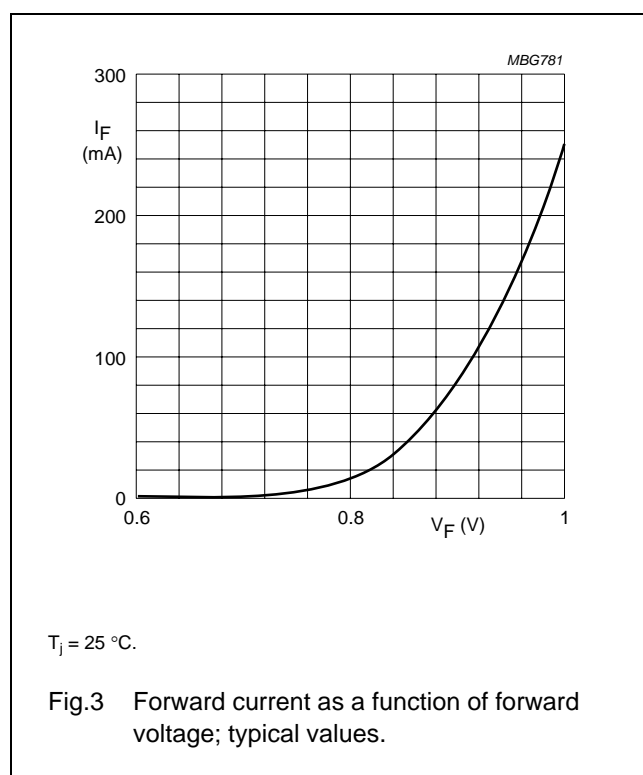
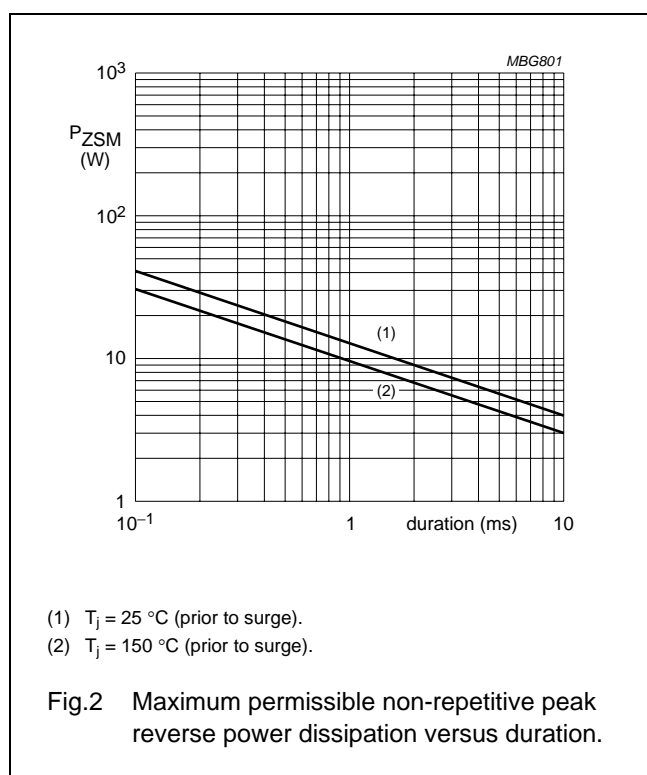

Voltage regulator diodes

BZV49 series

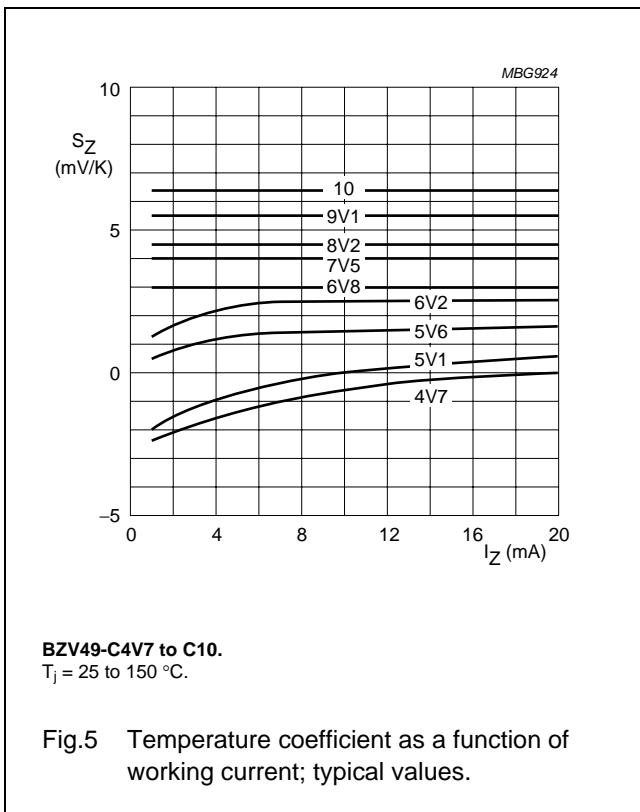
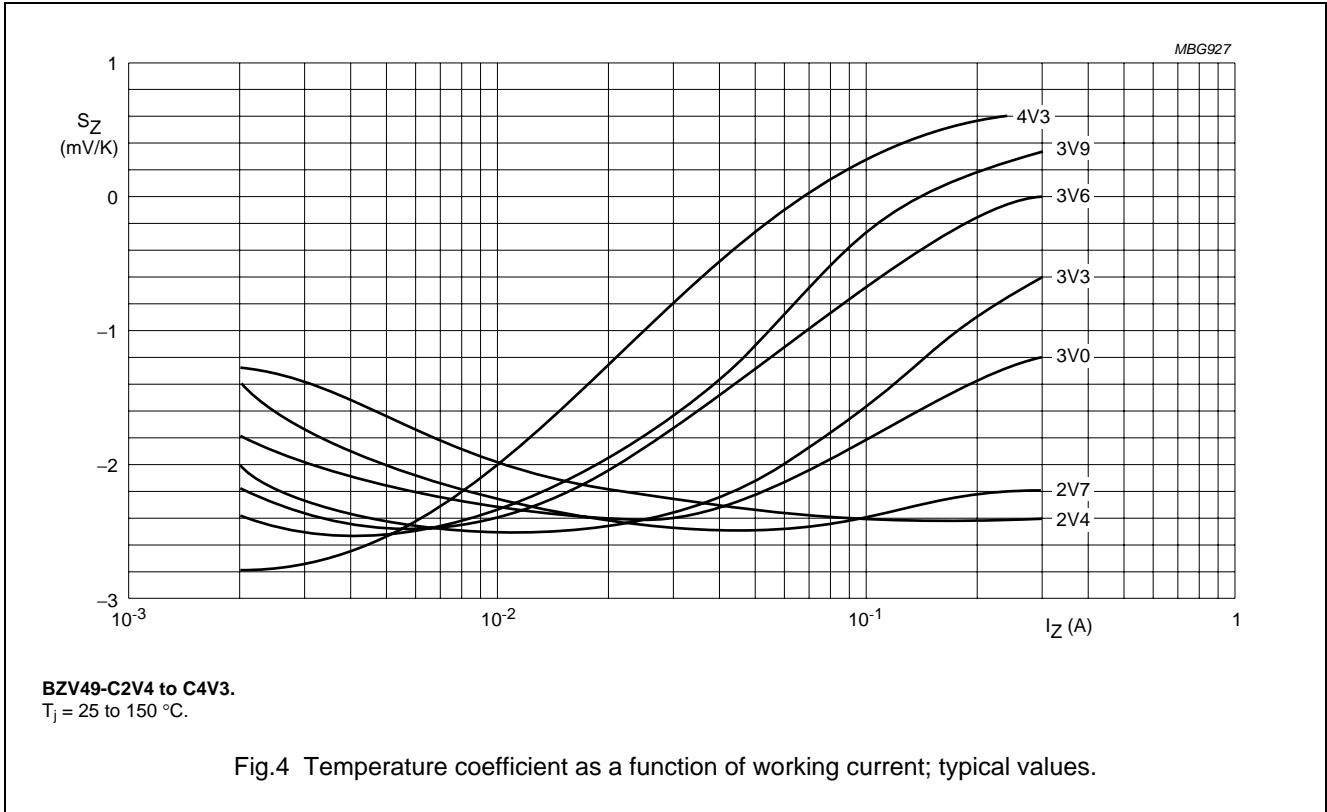

Voltage regulator diodes

BZV49 series

PACKAGE OUTLINE

Plastic surface-mounted package; collector pad for good heat transfer; 3 leads

SOT89

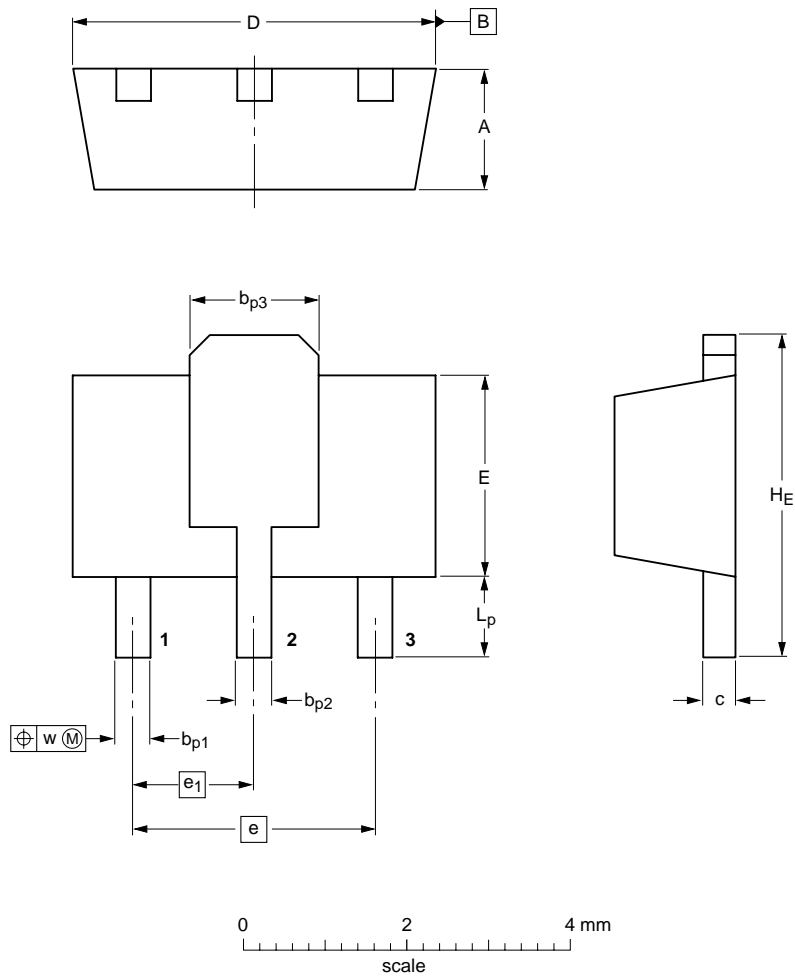

DIMENSIONS (mm are the original dimensions)

UNIT	A	b _{p1}	b _{p2}	b _{p3}	c	D	E	e	e ₁	H _E	L _p	w
mm	1.6 1.4	0.48 0.35	0.53 0.40	1.8 1.4	0.44 0.23	4.6 4.4	2.6 2.4	3.0	1.5	4.25 3.75	1.2 0.8	0.13

OUTLINE VERSION	REFERENCES				EUROPEAN PROJECTION	ISSUE DATE
	IEC	JEDEC	JEITA			
SOT89		TO-243	SC-62			04-08-03 06-03-16

Voltage regulator diodes

BZV49 series

DATA SHEET STATUS

DOCUMENT STATUS ⁽¹⁾	PRODUCT STATUS ⁽²⁾	DEFINITION
Objective data sheet	Development	This document contains data from the objective specification for product development.
Preliminary data sheet	Qualification	This document contains data from the preliminary specification.
Product data sheet	Production	This document contains the product specification.

Notes

1. Please consult the most recently issued document before initiating or completing a design.
2. The product status of device(s) described in this document may have changed since this document was published and may differ in case of multiple devices. The latest product status information is available on the Internet at URL <http://www.nxp.com>.

DISCLAIMERS

General — Information in this document is believed to be accurate and reliable. However, NXP Semiconductors does not give any representations or warranties, expressed or implied, as to the accuracy or completeness of such information and shall have no liability for the consequences of use of such information.

Right to make changes — NXP Semiconductors reserves the right to make changes to information published in this document, including without limitation specifications and product descriptions, at any time and without notice. This document supersedes and replaces all information supplied prior to the publication hereof.

Suitability for use — NXP Semiconductors products are not designed, authorized or warranted to be suitable for use in medical, military, aircraft, space or life support equipment, nor in applications where failure or malfunction of an NXP Semiconductors product can reasonably be expected to result in personal injury, death or severe property or environmental damage. NXP Semiconductors accepts no liability for inclusion and/or use of NXP Semiconductors products in such equipment or applications and therefore such inclusion and/or use is at the customer's own risk.

Applications — Applications that are described herein for any of these products are for illustrative purposes only. NXP Semiconductors makes no representation or warranty that such applications will be suitable for the specified use without further testing or modification.

Limiting values — Stress above one or more limiting values (as defined in the Absolute Maximum Ratings System of IEC 60134) may cause permanent damage to the device. Limiting values are stress ratings only and operation of the device at these or any other conditions

above those given in the Characteristics sections of this document is not implied. Exposure to limiting values for extended periods may affect device reliability.

Terms and conditions of sale — NXP Semiconductors products are sold subject to the general terms and conditions of commercial sale, as published at <http://www.nxp.com/profile/terms>, including those pertaining to warranty, intellectual property rights infringement and limitation of liability, unless explicitly otherwise agreed to in writing by NXP Semiconductors. In case of any inconsistency or conflict between information in this document and such terms and conditions, the latter will prevail.

No offer to sell or license — Nothing in this document may be interpreted or construed as an offer to sell products that is open for acceptance or the grant, conveyance or implication of any license under any copyrights, patents or other industrial or intellectual property rights.

Export control — This document as well as the item(s) described herein may be subject to export control regulations. Export might require a prior authorization from national authorities.

Quick reference data — The Quick reference data is an extract of the product data given in the Limiting values and Characteristics sections of this document, and as such is not complete, exhaustive or legally binding.

NXP Semiconductors

Customer notification

This data sheet was changed to reflect the new company name NXP Semiconductors, including new legal definitions and disclaimers. No changes were made to the technical content, except for package outline drawings which were updated to the latest version.

Contact information

For additional information please visit: <http://www.nxp.com>

For sales offices addresses send e-mail to: salesaddresses@nxp.com

© NXP B.V. 2009

All rights are reserved. Reproduction in whole or in part is prohibited without the prior written consent of the copyright owner.

The information presented in this document does not form part of any quotation or contract, is believed to be accurate and reliable and may be changed without notice. No liability will be accepted by the publisher for any consequence of its use. Publication thereof does not convey nor imply any license under patent- or other industrial or intellectual property rights.

Printed in The Netherlands

R76/04/pp10

Date of release: 2005 Feb 03

Document order number: 9397 750 13926

