

# NDD03N50Z

## N-Channel Power MOSFET 500 V, 3.3 Ω

### Features

- Low ON Resistance
- Low Gate Charge
- ESD Diode–Protected Gate
- 100% Avalanche Tested
- These Devices are Pb–Free, Halogen Free/BFR Free and are RoHS Compliant

### ABSOLUTE MAXIMUM RATINGS (T<sub>C</sub> = 25°C unless otherwise noted)

Rating	Symbol	Value	Unit
Drain–to–Source Voltage	V <sub>DSS</sub>	500	V
Continuous Drain Current R <sub>θJC</sub>	I <sub>D</sub>	2.6	A
Continuous Drain Current R <sub>θJC</sub> , T <sub>A</sub> = 100°C	I <sub>D</sub>	1.7	A
Pulsed Drain Current, V <sub>GS</sub> @ 10 V	I <sub>DM</sub>	10	A
Power Dissipation R <sub>θJC</sub>	P <sub>D</sub>	58	W
Gate–to–Source Voltage	V <sub>GS</sub>	±30	V
Single Pulse Avalanche Energy, I <sub>D</sub> = 2.6 A	E <sub>AS</sub>	120	mJ
ESD (HBM) (JESD22–A114)	V <sub>esd</sub>	2000	V
Peak Diode Recovery	dv/dt	4.5 (Note 1)	V/ns
Continuous Source Current (Body Diode)	I <sub>S</sub>	2.6	A
Maximum Temperature for Soldering Leads	T <sub>L</sub>	260	°C
Operating Junction and Storage Temperature Range	T <sub>J</sub> , T <sub>stg</sub>	–55 to 150	°C

Stresses exceeding Maximum Ratings may damage the device. Maximum Ratings are stress ratings only. Functional operation above the Recommended Operating Conditions is not implied. Extended exposure to stresses above the Recommended Operating Conditions may affect device reliability.

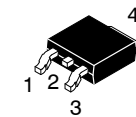
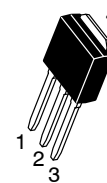
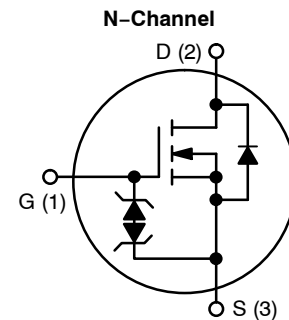
1. I<sub>D</sub> ≤ 2.6 A, di/dt ≤ 200 A/μs, V<sub>DD</sub> ≤ BV<sub>DSS</sub>, T<sub>J</sub> ≤ 150°C.



**ON Semiconductor®**

<http://onsemi.com>

V <sub>DSS</sub>	R <sub>DS(on)</sub> (MAX) @ 1.15 A
500 V	3.3 Ω



### MARKING AND ORDERING INFORMATION

See detailed ordering and shipping information in the package dimensions section on page 6 of this data sheet.

# NDD03N50Z

## THERMAL RESISTANCE

Parameter	Symbol	Value	Unit
Junction-to-Case (Drain)	$R_{\theta JC}$	2.2	°C/W
Junction-to-Ambient Steady State	(Note 3) NDD03N50Z (Note 2) NDD03N50Z-1	41 80	

2. Insertion mounted

3. Surface mounted on FR4 board using 1" sq. pad size, (Cu area = 1.127 in sq [2 oz] including traces).

## ELECTRICAL CHARACTERISTICS ( $T_J = 25^\circ\text{C}$ unless otherwise noted)

Characteristic	Symbol	Test Conditions	Min	Typ	Max	Unit
----------------	--------	-----------------	-----	-----	-----	------

### OFF CHARACTERISTICS

Drain-to-Source Breakdown Voltage	$BV_{DSS}$	$V_{GS} = 0\text{ V}, I_D = 1\text{ mA}$	500			V
Breakdown Voltage Temperature Coefficient	$\Delta BV_{DSS}/\Delta T_J$	Reference to $25^\circ\text{C}$ , $I_D = 1\text{ mA}$		0.6		V/°C
Drain-to-Source Leakage Current	$I_{DSS}$	$V_{DS} = 500\text{ V}, V_{GS} = 0\text{ V}$	25°C		1.0	μA
			150°C		50	
Gate-to-Source Forward Leakage	$I_{GSS}$	$V_{GS} = \pm 20\text{ V}$			±10	μA

### ON CHARACTERISTICS (Note 4)

Static Drain-to-Source On-Resistance	$R_{DS(on)}$	$V_{GS} = 10\text{ V}, I_D = 1.15\text{ A}$		2.8	3.3	Ω
Gate Threshold Voltage	$V_{GS(th)}$	$V_{DS} = V_{GS}, I_D = 50\text{ }\mu\text{A}$	3.0		4.5	V
Forward Transconductance	$g_{FS}$	$V_{DS} = 15\text{ V}, I_D = 1.15\text{ A}$		1.8		S

### DYNAMIC CHARACTERISTICS

Input Capacitance (Note 5)	$C_{iss}$	$V_{DS} = 25\text{ V}, V_{GS} = 0\text{ V},$ $f = 1.0\text{ MHz}$	219	274	329	pF
Output Capacitance (Note 5)	$C_{oss}$		28	38	50	
Reverse Transfer Capacitance (Note 5)	$C_{rss}$		6.0	8.0	10	
Total Gate Charge (Note 5)	$Q_g$	$V_{DD} = 250\text{ V}, I_D = 2.6\text{ A},$ $V_{GS} = 10\text{ V}$	5.0	10	16	nC
Gate-to-Source Charge (Note 5)	$Q_{gs}$		1.2	2.3	4.0	
Gate-to-Drain ("Miller") Charge (Note 5)	$Q_{gd}$		3.2	5.5	8.0	
Plateau Voltage	$V_{GP}$		6.4			V
Gate Resistance	$R_g$		1.5	4.5	13.5	Ω

### RESISTIVE SWITCHING CHARACTERISTICS

Turn-On Delay Time	$t_{d(on)}$	$V_{DD} = 250\text{ V}, I_D = 2.6\text{ A},$ $V_{GS} = 10\text{ V}, R_G = 5\text{ }\Omega$		9.0		ns
Rise Time	$t_r$			7.0		
Turn-Off Delay Time	$t_{d(off)}$			15		
Fall Time	$t_f$			7.0		

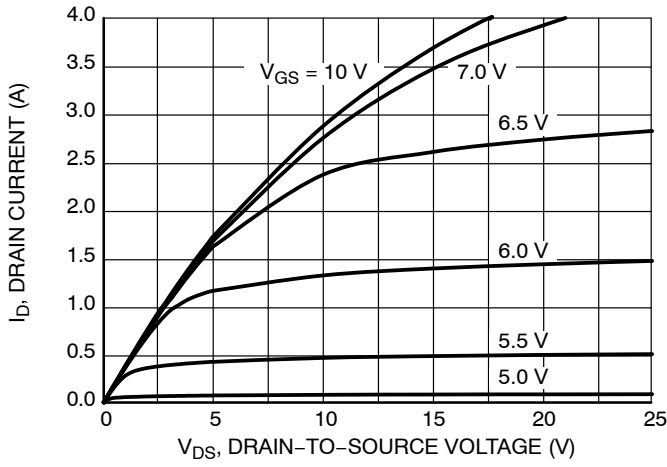
### SOURCE-DRAIN DIODE CHARACTERISTICS ( $T_C = 25^\circ\text{C}$ unless otherwise noted)

Diode Forward Voltage	$V_{SD}$	$I_S = 2.6\text{ A}, V_{GS} = 0\text{ V}$			1.6	V
Reverse Recovery Time	$t_{rr}$	$V_{GS} = 0\text{ V}, V_{DD} = 30\text{ V}$ $I_S = 2.6\text{ A}, di/dt = 100\text{ A}/\mu\text{s}$		240		ns
Reverse Recovery Charge	$Q_{rr}$			0.7		μC

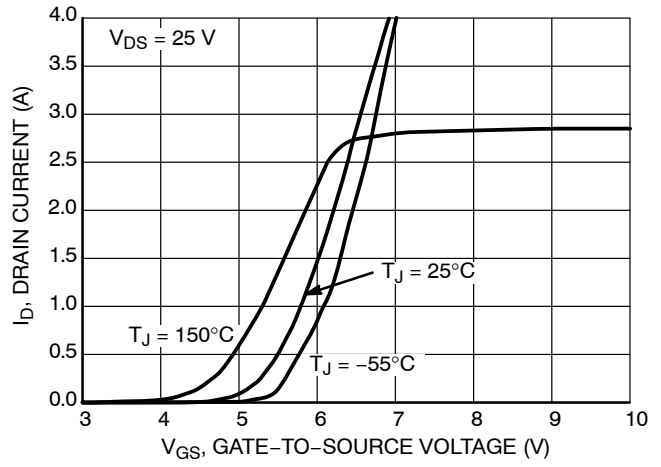
4. Pulse Width  $\leq 380\text{ }\mu\text{s}$ , Duty Cycle  $\leq 2\%$ .

5. Guaranteed by design.

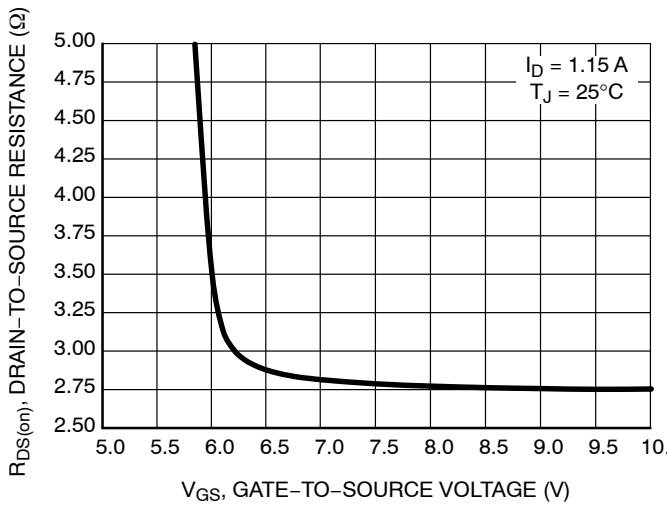
# NDD03N50Z



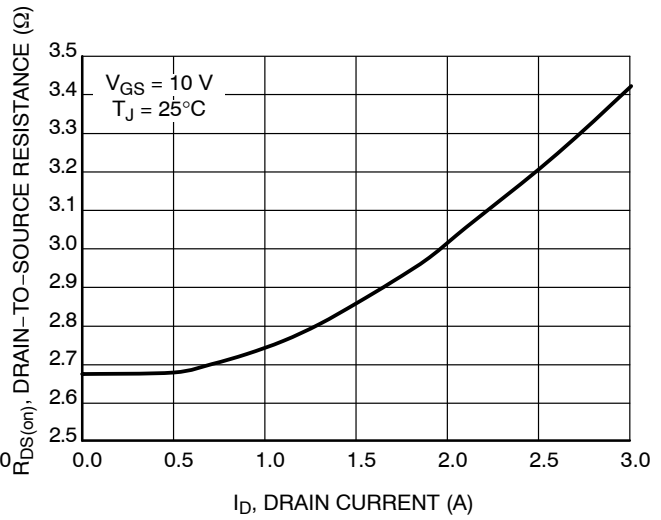
**Figure 1. On-Region Characteristics**



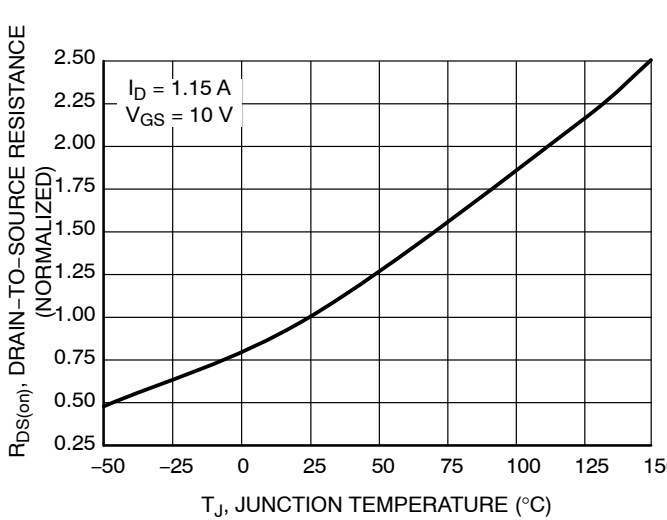
**Figure 2. Transfer Characteristics**



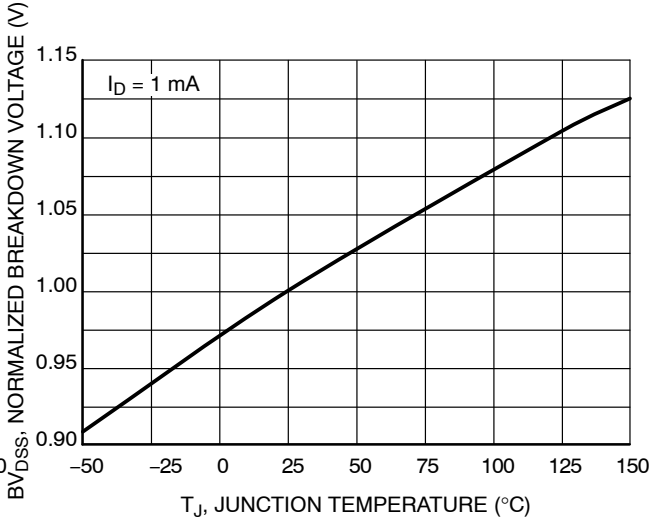
**Figure 3. On-Region versus Gate-to-Source Voltage**



**Figure 4. On-Resistance versus Drain Current and Gate Voltage**

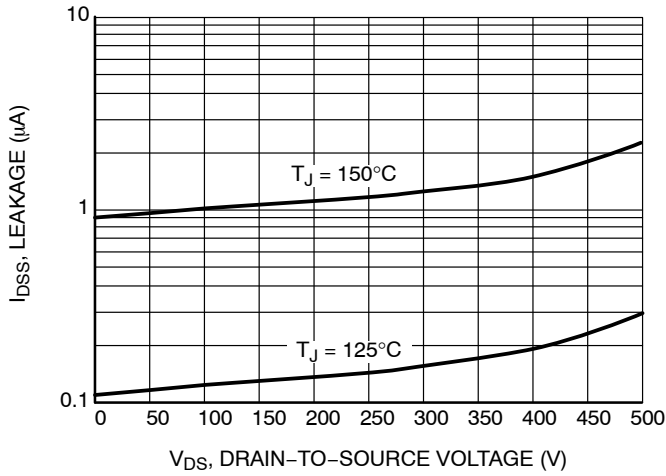


**Figure 5. On-Resistance Variation with Temperature**

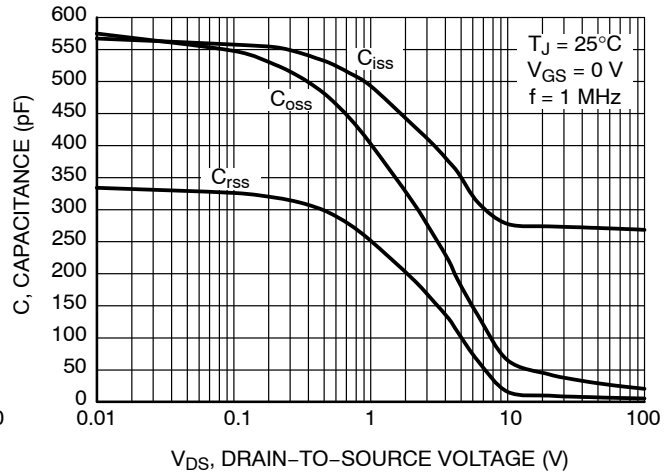


**Figure 6.  $BV_{DS}$  Variation with Temperature**

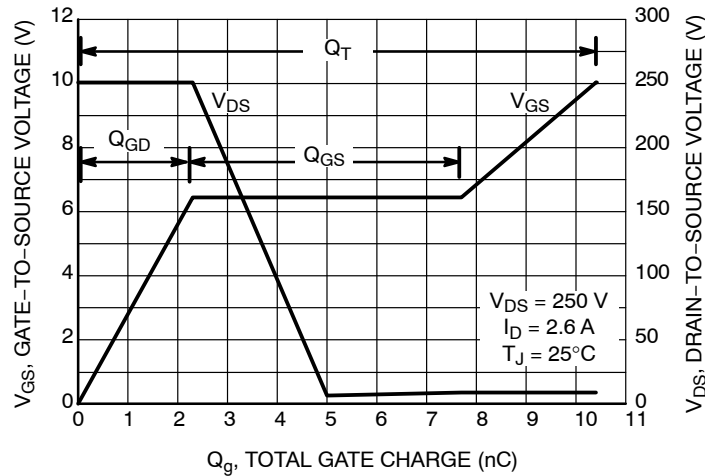
# NDD03N50Z



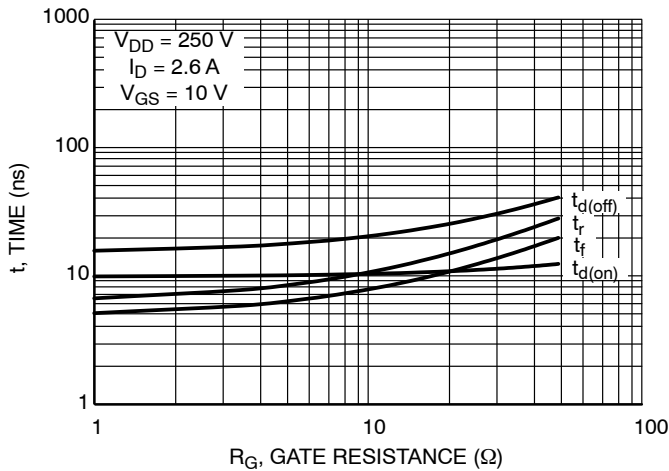
**Figure 7. Drain-to-Source Leakage Current versus Voltage**



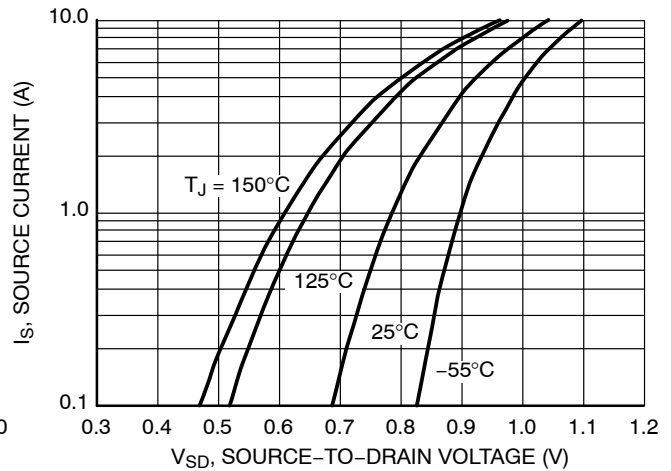
**Figure 8. Capacitance Variation**



**Figure 9. Gate-to-Source Voltage and Drain-to-Source Voltage versus Total Charge**

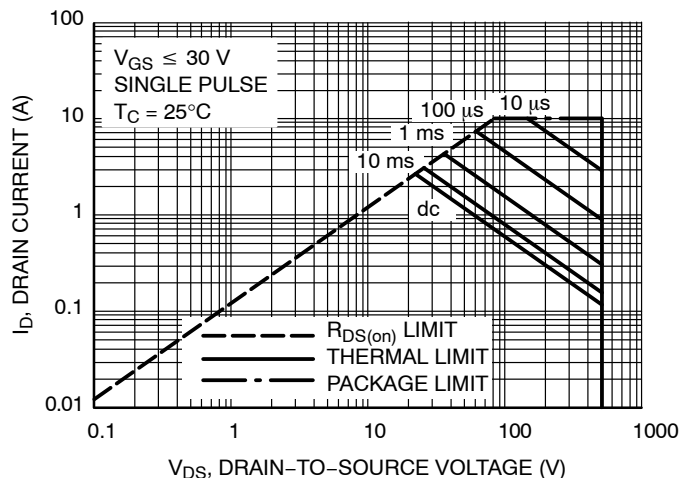


**Figure 10. Resistive Switching Time Variation versus Gate Resistance**

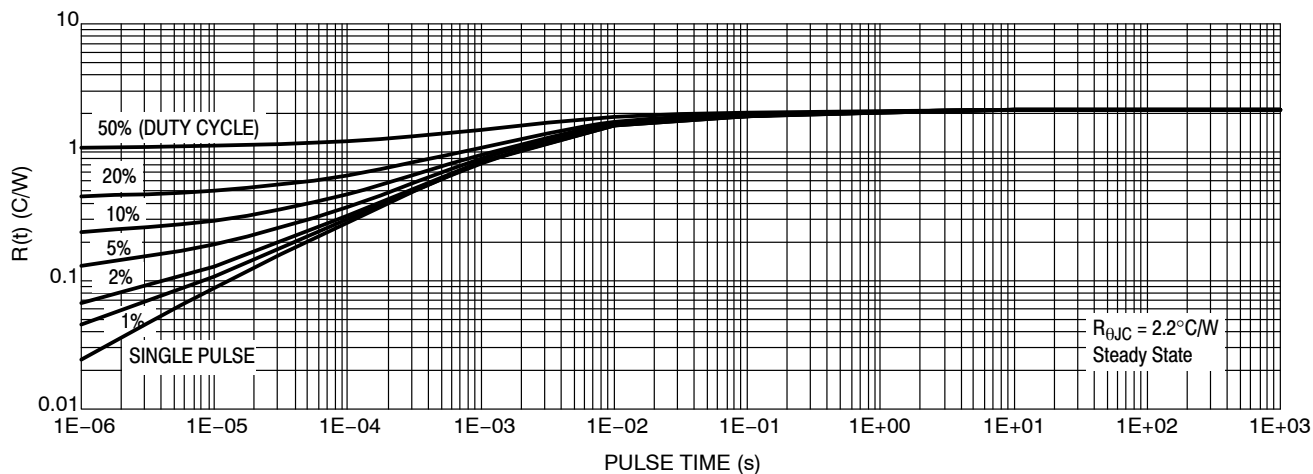


**Figure 11. Diode Forward Voltage versus Current**

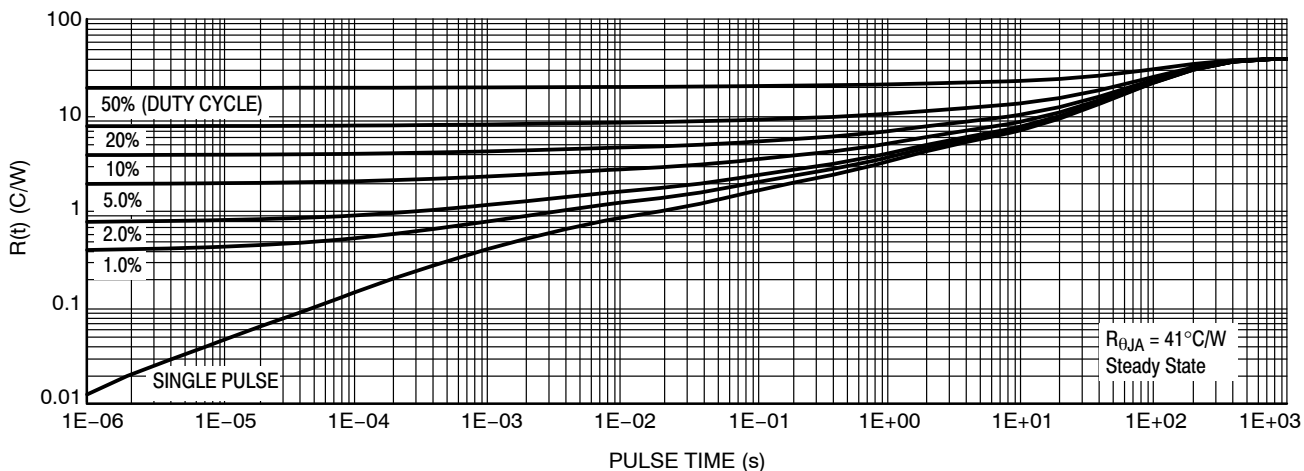
# NDD03N50Z



**Figure 12. Maximum Rated Forward Biased Safe Operating Area NDD03N50Z**



**Figure 13. Thermal Impedance (Junction-to-Case) for NDD03N50Z**



**Figure 14. Thermal Impedance (Junction-to-Ambient) for NDD03N50Z**

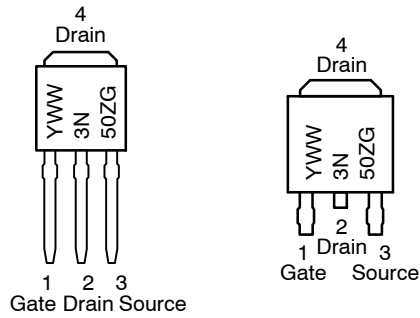
# NDD03N50Z

## ORDERING INFORMATION

Order Number	Package	Shipping†
NDD03N50Z-1G	IPAK (Pb-Free)	75 Units / Rail
NDD03N50ZT4G	DPAK (Pb-Free)	2500 / Tape & Reel

†For information on tape and reel specifications, including part orientation and tape sizes, please refer to our Tape and Reel Packaging Specifications Brochure, BRD8011/D.

## MARKING DIAGRAMS



- A = Location Code
- Y = Year
- WW = Work Week
- G = Pb-Free Package

# MECHANICAL CASE OUTLINE

## PACKAGE DIMENSIONS

ON Semiconductor®



### IPAK CASE 369D-01 ISSUE C

DATE 15 DEC 2010

SCALE 1:1



- NOTES:
- DIMENSIONING AND TOLERANCING PER ANSI Y14.5M, 1982.
  - CONTROLLING DIMENSION: INCH.

DIM	INCHES		MILLIMETERS	
	MIN	MAX	MIN	MAX
A	0.235	0.245	5.97	6.35
B	0.250	0.265	6.35	6.73
C	0.086	0.094	2.19	2.38
D	0.027	0.035	0.69	0.88
E	0.018	0.023	0.46	0.58
F	0.037	0.045	0.94	1.14
G	0.090	BSC	2.29	BSC
H	0.034	0.040	0.87	1.01
J	0.018	0.023	0.46	0.58
K	0.350	0.380	8.89	9.65
R	0.180	0.215	4.45	5.45
S	0.025	0.040	0.63	1.01
V	0.035	0.050	0.89	1.27
Z	0.155	---	3.93	---

- |  |   |  |  |
|--|---|--|--|
| <p>STYLE 1:<br/>PIN 1. BASE<br/>2. COLLECTOR<br/>3. EMITTER<br/>4. COLLECTOR</p> | <p>STYLE 2:<br/>PIN 1. GATE<br/>2. DRAIN<br/>3. SOURCE<br/>4. DRAIN</p> | <p>STYLE 3:<br/>PIN 1. ANODE<br/>2. CATHODE<br/>3. ANODE<br/>4. CATHODE</p>      | <p>STYLE 4:<br/>PIN 1. CATHODE<br/>2. ANODE<br/>3. GATE<br/>4. ANODE</p> |
| <p>STYLE 5:<br/>PIN 1. GATE<br/>2. ANODE<br/>3. CATHODE<br/>4. ANODE</p>         | <p>STYLE 6:<br/>PIN 1. MT1<br/>2. MT2<br/>3. GATE<br/>4. MT2</p>        | <p>STYLE 7:<br/>PIN 1. GATE<br/>2. COLLECTOR<br/>3. EMITTER<br/>4. COLLECTOR</p> |  |

### MARKING DIAGRAMS



- xxxxxxxxx = Device Code  
A = Assembly Location  
IL = Wafer Lot  
Y = Year  
WW = Work Week

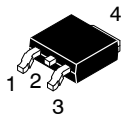
<b>DOCUMENT NUMBER:</b>	<b>98AON10528D</b>	Electronic versions are uncontrolled except when accessed directly from the Document Repository. Printed versions are uncontrolled except when stamped "CONTROLLED COPY" in red.
<b>DESCRIPTION:</b>	<b>IPAK (DPAK INSERTION MOUNT)</b>	<b>PAGE 1 OF 1</b>

ON Semiconductor and are trademarks of Semiconductor Components Industries, LLC dba ON Semiconductor or its subsidiaries in the United States and/or other countries. ON Semiconductor reserves the right to make changes without further notice to any products herein. ON Semiconductor makes no warranty, representation or guarantee regarding the suitability of its products for any particular purpose, nor does ON Semiconductor assume any liability arising out of the application or use of any product or circuit, and specifically disclaims any and all liability, including without limitation special, consequential or incidental damages. ON Semiconductor does not convey any license under its patent rights nor the rights of others.

# MECHANICAL CASE OUTLINE

## PACKAGE DIMENSIONS

ON Semiconductor®



SCALE 1:1

### DPAK (SINGLE GAUGE)

#### CASE 369AA-01

#### ISSUE B

DATE 03 JUN 2010



NOTES:

- DIMENSIONING AND TOLERANCING PER ASME Y14.5M, 1994.
- CONTROLLING DIMENSION: INCHES.
- THERMAL PAD CONTOUR OPTIONAL WITHIN DIMENSIONS b3, L3 and Z.
- DIMENSIONS D AND E DO NOT INCLUDE MOLD FLASH, PROTRUSIONS, OR BURRS. MOLD FLASH, PROTRUSIONS, OR GATE BURRS SHALL NOT EXCEED 0.006 INCHES PER SIDE.
- DIMENSIONS D AND E ARE DETERMINED AT THE OUTERMOST EXTREMES OF THE PLASTIC BODY.
- DATUMS A AND B ARE DETERMINED AT DATUM PLANE H.

DIM	INCHES		MILLIMETERS	
	MIN	MAX	MIN	MAX
A	0.086	0.094	2.18	2.38
A1	0.000	0.005	0.00	0.13
b	0.025	0.035	0.63	0.89
b2	0.030	0.045	0.76	1.14
b3	0.180	0.215	4.57	5.46
c	0.018	0.024	0.46	0.61
c2	0.018	0.024	0.46	0.61
D	0.235	0.245	5.97	6.22
E	0.250	0.265	6.35	6.73
e	0.090 BSC		2.29 BSC	
H	0.370	0.410	9.40	10.41
L	0.055	0.070	1.40	1.78
L1	0.108 REF		2.74 REF	
L2	0.020 BSC		0.51 BSC	
L3	0.035	0.050	0.89	1.27
L4	---	0.040	---	1.01
Z	0.155	---	3.93	---

- |  |   |  |  |
|--|---|--|--|
| <p>STYLE 1:<br/>PIN 1. BASE<br/>2. COLLECTOR<br/>3. EMITTER<br/>4. COLLECTOR</p> | <p>STYLE 2:<br/>PIN 1. GATE<br/>2. DRAIN<br/>3. SOURCE<br/>4. DRAIN</p> | <p>STYLE 3:<br/>PIN 1. ANODE<br/>2. CATHODE<br/>3. ANODE<br/>4. CATHODE</p>      | <p>STYLE 4:<br/>PIN 1. CATHODE<br/>2. ANODE<br/>3. GATE<br/>4. ANODE</p> |
| <p>STYLE 5:<br/>PIN 1. GATE<br/>2. ANODE<br/>3. CATHODE<br/>4. ANODE</p>         | <p>STYLE 6:<br/>PIN 1. MT1<br/>2. MT2<br/>3. GATE<br/>4. MT2</p>        | <p>STYLE 7:<br/>PIN 1. GATE<br/>2. COLLECTOR<br/>3. EMITTER<br/>4. COLLECTOR</p> |  |

### GENERIC MARKING DIAGRAM\*



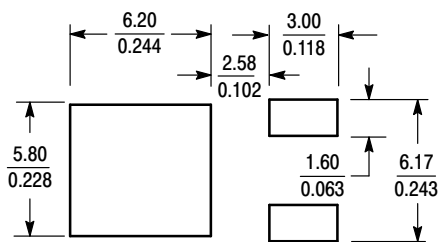
IC

Discrete

- XXXXXX = Device Code
- A = Assembly Location
- L = Wafer Lot
- Y = Year
- WW = Work Week
- G = Pb-Free Package

\*This information is generic. Please refer to device data sheet for actual part marking.

### SOLDERING FOOTPRINT\*



SCALE 3:1 (mm/inches)

\*For additional information on our Pb-Free strategy and soldering details, please download the ON Semiconductor Soldering and Mounting Techniques Reference Manual, SOLDERRM/D.

DOCUMENT NUMBER:	98AON13126D	Electronic versions are uncontrolled except when accessed directly from the Document Repository. Printed versions are uncontrolled except when stamped "CONTROLLED COPY" in red.
DESCRIPTION:	DPAK (SINGLE GAUGE)	PAGE 1 OF 1

ON Semiconductor and ON are trademarks of Semiconductor Components Industries, LLC dba ON Semiconductor or its subsidiaries in the United States and/or other countries. ON Semiconductor reserves the right to make changes without further notice to any products herein. ON Semiconductor makes no warranty, representation or guarantee regarding the suitability of its products for any particular purpose, nor does ON Semiconductor assume any liability arising out of the application or use of any product or circuit, and specifically disclaims any and all liability, including without limitation special, consequential or incidental damages. ON Semiconductor does not convey any license under its patent rights nor the rights of others.



**onsemi**, **Onsemi**, and other names, marks, and brands are registered and/or common law trademarks of Semiconductor Components Industries, LLC dba "**onsemi**" or its affiliates and/or subsidiaries in the United States and/or other countries. **onsemi** owns the rights to a number of patents, trademarks, copyrights, trade secrets, and other intellectual property. A listing of **onsemi**'s product/patent coverage may be accessed at [www.onsemi.com/site/pdf/Patent-Marking.pdf](http://www.onsemi.com/site/pdf/Patent-Marking.pdf). **onsemi** reserves the right to make changes at any time to any products or information herein, without notice. The information herein is provided "as-is" and **onsemi** makes no warranty, representation or guarantee regarding the accuracy of the information, product features, availability, functionality, or suitability of its products for any particular purpose, nor does **onsemi** assume any liability arising out of the application or use of any product or circuit, and specifically disclaims any and all liability, including without limitation special, consequential or incidental damages. Buyer is responsible for its products and applications using **onsemi** products, including compliance with all laws, regulations and safety requirements or standards, regardless of any support or applications information provided by **onsemi**. "Typical" parameters which may be provided in **onsemi** data sheets and/or specifications can and do vary in different applications and actual performance may vary over time. All operating parameters, including "Typicals" must be validated for each customer application by customer's technical experts. **onsemi** does not convey any license under any of its intellectual property rights nor the rights of others. **onsemi** products are not designed, intended, or authorized for use as a critical component in life support systems or any FDA Class 3 medical devices or medical devices with a same or similar classification in a foreign jurisdiction or any devices intended for implantation in the human body. Should Buyer purchase or use **onsemi** products for any such unintended or unauthorized application, Buyer shall indemnify and hold **onsemi** and its officers, employees, subsidiaries, affiliates, and distributors harmless against all claims, costs, damages, and expenses, and reasonable attorney fees arising out of, directly or indirectly, any claim of personal injury or death associated with such unintended or unauthorized use, even if such claim alleges that **onsemi** was negligent regarding the design or manufacture of the part. **onsemi** is an Equal Opportunity/Affirmative Action Employer. This literature is subject to all applicable copyright laws and is not for resale in any manner.

## PUBLICATION ORDERING INFORMATION

### LITERATURE FULFILLMENT:

Email Requests to: [orderlit@onsemi.com](mailto:orderlit@onsemi.com)

**onsemi Website:** [www.onsemi.com](http://www.onsemi.com)

### TECHNICAL SUPPORT

**North American Technical Support:**  
Voice Mail: 1 800-282-9855 Toll Free USA/Canada  
Phone: 011 421 33 790 2910

**Europe, Middle East and Africa Technical Support:**

Phone: 00421 33 790 2910

For additional information, please contact your local Sales Representative