

ECN/PCN No.: R0043

For Manufacturer			
Product Description: Bluetooth modules	Abracon Part Number / Part Series: ABBTM Bluetooth module series	<input type="checkbox"/> Documentation only <input type="checkbox"/> ECN <input checked="" type="checkbox"/> EOL	<input checked="" type="checkbox"/> Series <input type="checkbox"/> Part Number
Affected Revision: N/A	New Revision: EOL	Application: <input type="checkbox"/> Safety <input checked="" type="checkbox"/> Non-Safety	
Prior to Change: ABBTM-2.4GHZ, ABBTM-2.4GHZ-31, ABBTM-2.4GHZ-31-T, ABBTM-2.4GHZ-33, ABBTM-2.4GHZ-33-T, ABBTM-2.4GHZ-51, ABBTM-2.4GHZ-51-T, ABBTM-2.4GHZ-52, ABBTM-2.4GHZ-52-T, ABBTM-2.4GHZ-EVAL, ABBTM-2.4GHZ-T, ABBTM-2.4GHZ-T2, ABBTM-NVC-EVK-56, ABBTM-NVC-EVK-71, ABBTM-NVC-EVK-71-MESH, ABBTM-NVC-MB-EVK, ABBTM-NVC-MDCS42A-CON, ABBTM-NVC-MDCS71, ABBTM-NVC-MDCS71-CON, ABBTM-NVC-MDCS71-MESH, ABBTM-NVC-MDCS71-MESH-CON, ABBTM-NVC-MDCS71-101, ABBTM-NVC-MDCS86-101, ABBTM-101-2.4GHZ-T, ABBTM-2.4GHZ-51-101-, ABBTM-2.4GHZ-52-101, ABBTM-53-2.4GHZ-T, ABBTM-103-2.4GHZ-T, ABBTM-2.4GHZ-T; VER.10, ABBTM-NVC-MDCS42A-101, ABBTM-NVC-MDCS42A-F07, and ABBTM-NVC-MDCS56-102.			
After Change: All 32 EOL			
Cause/Reason for Change: Due to low demand, the Bluetooth Module ABBTM series is discontinued.			
Change Plan			
Effective Date: 06/08/2021	Additional Remarks: N/A		
Change Declaration: EOL			
Issued Date: 06/08/2021	Issued By: <i>Nicholas El-Takach</i>	Issued Department: Engineering	
Approval: <i>Syed Raza</i> Engineering VP	Approval: <i>Reuben Quintanilla</i> Quality Director	Approval: <i>Ying Huang</i> Purchasing Director	
For Abracon EOL only			
Last Time Buy (if applicable): No last time buy.	Alternate Part Number / Part Series: N/A		
Additional Approval:	Additional Approval:	Additional Approval:	
Customer Approval (If Applicable)			
Qualification Status: <input type="checkbox"/> Approved <input type="checkbox"/> Not accepted <i>Note: It is considered approved if there is no feedback from the customer 1 month after ECN/PCN is released.</i>			
Customer Part Number:		Customer Project:	
Company Name:	Company Representative:	Representative Signature:	
Customer Remarks:			

Low Power Bluetooth Module (supporting CSRmesh)

ABBTM-NVC-MDCS71-MESH



RoHS/RoHS II compliant



19.5 x 12.5 x 2.4 mm SMT

Moisture Sensitivity Level (MSL) – Level 3

FEATURES:

- Single mode Bluetooth v4.1 low energy
- 4dBm maximum TX power/ -92.5dBm RX sensitivity, RSSI monitoring for proximity applications
- Support CSRmesh.
- UART/I²C master/SPI master interfaces
- 9 digital PIOs/3 analog IOs
- 10bit ADC IOs
- Wakeup interrupt and watchdog timer
- SMT pads for easy and reliable PCB mounting, Internal chip antenna
- 19.50x12.50x2.4mm
- FCC ID: OC3BM1871*
- QDID: B020997*

*Note: ABBTM-NVC-MDCS71-MESH crosses to NovaComm P/N: NVC-MDCS71. BQB/FCC certification documentation is under P/N: NVC-MDCS71.

APPLICATIONS:

Typical Bluetooth low energy applications:

- IoT applications
- Smart Home applications

GENERAL DESCRIPTION

ABBTM-NVC-MDCS71-MESH is a single-mode Bluetooth v4.1 low power module based on CSR's CSR1010. By integrating CSRmesh and Novacomm's proprietary technologies into the single module, it provides a simple solution for building intelligent network so devices can communicate with each other directly.

CSRmesh supports different device models. Current firmware combines light model (e.g. LED lights) and data model together. It allows the module to be used in a color LED light, or as a network endpoint to transmit data to each other. The module uses an ASCII command interface over its 2 wire UART port. The command details can be found in the Software Interface for Mesh Application Manual.

Current firmware allows the module to scan for data packets from nearby devices and relay the data if needed. It consumes approximately 20mA @3V, so it is suitable for applications with power supply connected. If low power consumption operation mode is needed, please contact Abracon for custom firmware.

PIN CONFIGURATION:

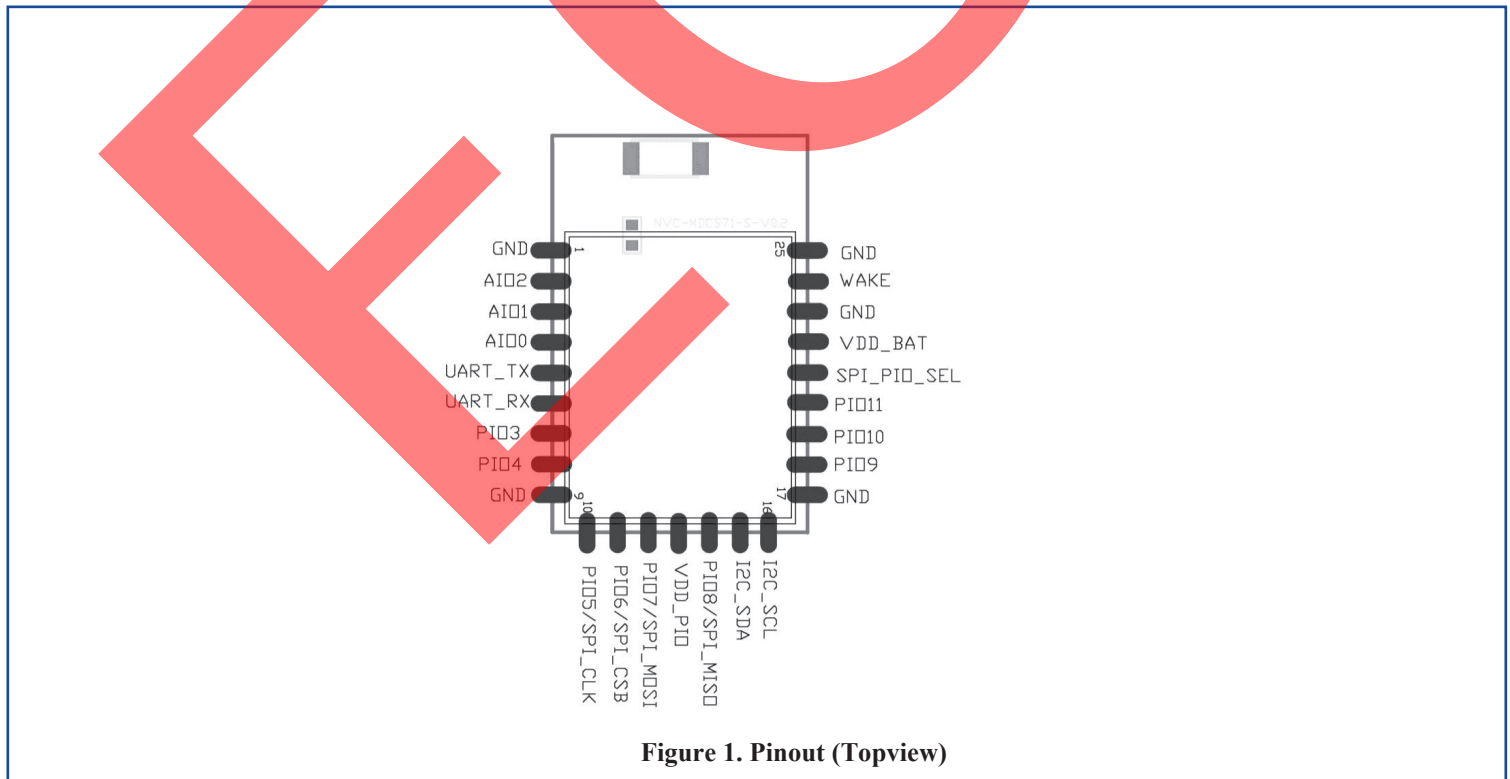

Figure 1. Pinout (Topview)

ABRACON IS
ISO 9001:2008
CERTIFIED



2 Faraday, Suite# B | Irvine | CA 92618 Revised: 06.29.15

Ph. 949.546.8000 | Fax. 949.546.8001

Visit www.abracon.com for Terms and Conditions of Sale

Low Power Bluetooth Module (supporting CSRmesh)

ABBTM-NVC-MDCS71-MESH

 RoHS/RoHS II compliant



19.5 x 12.5 x 2.4 mm SMT

PIN DESCRIPTION

Pin	Symbol	I/O Type	Description
1	GND	Ground	Ground
2	AIO2	Bidirectional analogue	10bit Analogue programmable I/O line
3	AIO1	Bidirectional analogue	10bit Analogue programmable I/O line
4	AIO0	Bidirectional analogue	10bit Analogue programmable I/O line
5	UART_TX	CMOS output, tri-state, with weak internal pull-up	UART data output
6	UART_RX	CMOS input with weak internal pull-down	UART data input
7	PIO3	Bi-directional with programmable strength internal pull-up/down	Programmable input/output line PWM or LED Controls
8	PIO4	Bi-directional with programmable strength internal pull-up/down	Programmable input/output line PWM or LED Controls
9	GND	Ground	Ground
10	PIO5/SPI_CLK	Bi-directional with programmable strength internal pull-up/down	Programmable input/output line Or debug SPI_CLK select by SPI_PIO_SEL
11	PIO6/SPI_CSB	Bi-directional with programmable strength internal pull-up/down	Programmable input/output line Or debug chip select, selected by SPI_PIO_SEL
12	PIO7/SPI_MOSI	Bi-directional with programmable strength internal pull-up/down	Programmable input/output line Or debug SPI_MOSI, selected by SPI_PIO_SEL
13	VDD_PIO	Powered	PIO power supply
14	PIO8/SPI_MISO	Bi-directional with programmable strength internal pull-up/down	Programmable input/output line Or debug SPI_MISO, selected by SPI_PIO_SEL
15	I2C_SDA	Bi-directional tri-state with weak internal pull-up	I2C data input/output or SPI serial flash data output(SF_OUT)
16	I2C_SCL	Input with weak internal pull-up	I2C clock or SPI serial flash clock output (SF_CLK)
17	GND	Ground	Ground
18	PIO9	Bi-directional with programmable strength internal pull-up/down	Programmable input/output line PWM or LED Controls
19	PIO10	Bi-directional with programmable strength internal pull-up/down	Programmable input/output line PWM or LED Controls
20	PIO11	Bi-directional with programmable strength internal pull-up/down	Programmable input/output line
21	SPI_PIO_SEL	Input with strong internal pull-down	Selects SPI debug on (8:5)
22	VDD_BAT	Power supply	Button cell battery or DC 1.8V to 3.6V
23	GND	Ground	Ground
24	WAKE	Input has no internal pull-up or pull-down use external pull-down	Set high to wake the module from hibernate. Use an external pull-down for this pin.
25	GND	Ground	Ground

Low Power Bluetooth Module (supporting CSRmesh)

ABBTM-NVC-MDCS71-MESH

 RoHS/RoHS II compliant



19.5 x 12.5 x 2.4 mm SMT

ELECTRICAL CHARACTERISTICS

Absolute Maximum Rating

Rating	Min	Max	Unit
Storage Temperature	-40	+85	°C
Battery (VDD_BAT) operation*	1.8	3.6	V
I/O supply voltage	-0.4	+3.6	V
Other Terminal Voltages except RF	V _{SS} -0.4	VDD+0.4	V

* Short-term operation up to a maximum of 10% of product lifetime is permissible without damage, but output regulation and other specifications are not guaranteed in excess of 4.2V.

Recommended Operating Conditions

Operating Condition	Min	Typ	Max	Unit
Operating Temperature Range	-30		+85	°C
Battery (VDD_BAT) operation	1.8		+3.6	V
I/O Supply Voltage (VDD_PIO)	1.2		+3.6	V

Power Consumptions

The current consumption are measured at the VDD_BAT.

Mode	Description	Total typical current at 3V (average)
Dormant	All functions are shutdown. To wake up toggle the WAKE pin	<600nA
Hibernate	All functions are shutdown except for the sleep clock. The module can wake up on a timer on the sleep clock.	<1.5uA
Fast Advertising	In 30 second after Power on VDD=3.3V	0.8mA
Slow Advertising	In 3 minutes after fast advertising VDD=3.3V	6uA
Standby (no connect)	VDD=3.3V, VDD_PIO=3.3v	5uA
Standby (connect)	VDD=3.3V, VDD_PIO=3.3v	8uA
Transmit data	VDD=3.3V VDD_PIO=3.3V	1mA
RF RX /TX active (0dBm) *	VDD=3.3V VDD_PIO=3.3V	~16mA peak

* Note: The TX power of the module can be increased by firmware to a maximum of 4dBm and the peak current is around 28mA.

Low Power Bluetooth Module (supporting CSRmesh)

ABBTM-NVC-MDCS71-MESH

 RoHS/RoHS II compliant



19.5 x 12.5 x 2.4 mm SMT

I/O CHARACTERISTICS

Digital I/O Characteristics

Supply Voltage Levels	Min	Typ	Max	Unit
Input Voltage Levels				
V _{IL} input logic level low	-0.4		0.4	V
V _{IH} input logic level high	0.7*VDD		VDD + 0.4	V
T _r /T _f			25	ns
Output Voltage Levels				
V _{OL} output logic level low, I _{OL} = 4.0mA			0.4	V
V _{OH} output logic level high, I _{OH} = -4.0mA	0.75*VDD			V
T _r /T _f			5	ns
Input and Tri-state Current				
With strong pull-up	-150	-40	-10	μA
With strong pull-down	10	40	150	μA
With weak pull-up	-5.0	-1.0	-0.33	μA
With weak pull-down	0.33	+1.0	5.0	μA
C _I Input Capacitance	1.0		5.0	pF

AIO Characteristics

Input Voltage Levels	Min	Typ	Max	Unit
AIO	0		1.3	V

ESD Protection

Condition	Class	Max Rating
Human Body Model Contact Discharge per JEDEC EIA/JESD22-A114	2	2000V (all pins)
Machine Model Contact Discharge per JEDEC EIA/JESD22-A115	200V	200V (all pins)
Charged Device Model Contact Discharge per JEDEC EIA/JESD22-C101	III	500V (all pins)

Low Power Bluetooth Module (supporting CSRmesh)

ABBTM-NVC-MDCS71-MESH

 RoHS/RoHS II compliant



19.5 x 12.5 x 2.4 mm SMT

PHYSICAL INTERFACES

Power Supply

The module integrates internal regulators. It can be easily powered up by connecting a 3V coin battery with a >100uF capacitor at pin VDD_BAT.

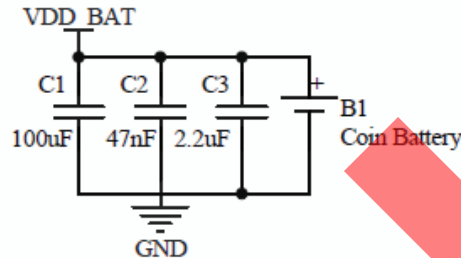

Figure 2. Capacitor at pin VDD_BAT

Internal Antenna

The module integrates an on-board chip antenna. There's no need to use external antenna on customer's PCB. Please take precaution to leave ample clearance for the antenna (See Figure 6).

PIO

9 PIOs are provided (4 are multiplexed with SPI debug interface). They are powered from VDD_PIO.

PIO lines are software-configurable as weak pull-up, weak pull-down, strong pull-up or strong pull-down.

Note: At reset all PIO lines are inputs with weak pull-downs. Any of the PIO lines can be configured as interrupt request lines or as wake-up lines from sleep modes.

AIO

3 AIOs are provided. They can be connected to internal 10 bits ADC. Depending on the software, they can be used to read or output a voltage between 0V to 1.3V. Each of them can be also used as a digital output with special firmware.

PWM

PIO3, PIO4, PIO9, PIO10 can be driven by internal PWM module. The PWM module also works while the module is sleep. Therefore it can be used as a LED flasher. These functions are controlled by special firmwares.

UART

This module has a standard UART interface which provides a simple mechanism for communicating with other serial devices using the RS232 protocol.

The UART CTS and RTS signals can be assigned to any PIO pin by the on-chip firmware.

Possible UART Settings

Parameter		Possible Values
Baud Rate	Minimum	1200 baud ($\leq 2\%$ Error)
	Maximum	9600 baud ($\leq 1\%$ Error)
Flow Control		RTS/CTS or None
Parity		None, Odd or Even
Number of Stop Bits		1 or 2
Bits per Byte		8

Low Power Bluetooth Module (supporting CSRmesh)

ABBTM-NVC-MDCS71-MESH

 RoHS/RoHS II compliant



19.5 x 12.5 x 2.4 mm SMT

PHYSICAL INTERFACES

I²C Master

The module can act as an I²C master when configured by software. Any two PIOs can be configured as I2C_SCL and I2C_SDA.

SPI Master

The module can act as an SPI master (mode 0) when configured by software. Any four PIOs can be configured as SPI_CLK, SPI_CS#, SPI_DIN and SPI_DOUT. The clock rate of the software SPI is around 470kHz.

SPI Debug

The SPI Debug interface is chosen when SPI_PIO_SEL is high. The interface is used to program and debug the module. So always place test points or header on PCB for this interface and SPI_PIO_SEL.

SOFTWARE STACK

ABBTM-NVC-MDCS71-MESH is a single mode Bluetooth 4.1 module. It integrates CSRmesh and Novacomm's proprietary control interface together so users can access mesh functions easily via the UART interface of the module.

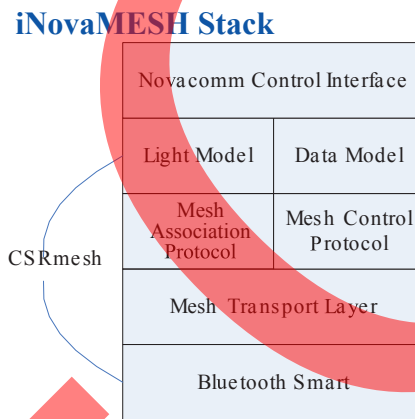

Figure 3. iNovaMESH Stack

REFERENCE DESIGN

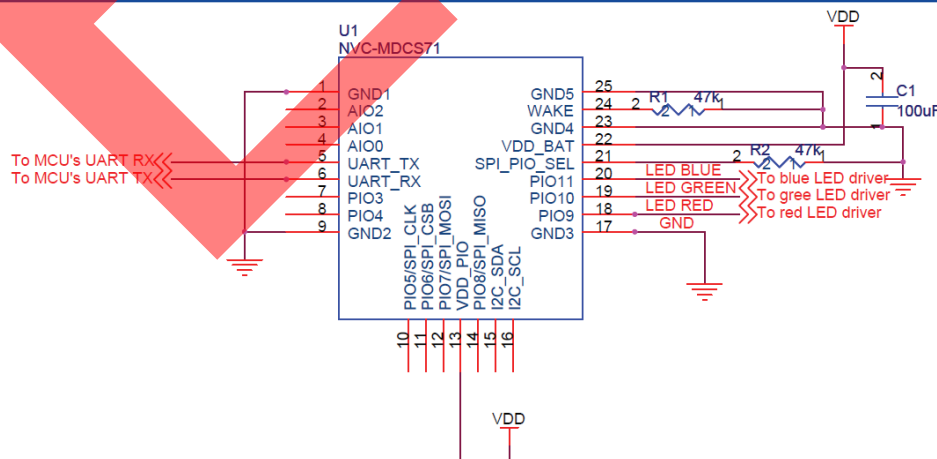

Figure 4. Reference Design

ABRACON IS
ISO 9001:2008
CERTIFIED



2 Faraday, Suite# B | Irvine | CA 92618 Revised: 06.29.15
Ph. 949.546.8000 | Fax. 949.546.8001
Visit www.abracon.com for Terms and Conditions of Sale

Low Power Bluetooth Module (supporting CSRmesh)

ABBTM-NVC-MDCS71-MESH

 RoHS/RoHS II compliant



19.5 x 12.5 x 2.4 mm SMT

LAYOUT AND SOLDERING

Soldering Recommendations

ABBTM-NVC-MDCS71 is compatible with industrial standard reflow profile for Pb-free solders. The reflow profile used is dependent on the thermal mass of the entire populated PCB, heat transfer efficiency of the oven and particular type of solder paste used. Please refer to the datasheet of the particular solder paste for profile configurations.

The following are recommended for soldering the module to ensure reliable solder joint and operation of the module after soldering. Since the profile used is process and layout dependent, the optimum profile should be studied case by case. Thus following recommendation should be taken as reference **only**.

- Refer to technical documentations of particular solder paste for **profile configurations**
- Avoid using more than one flow.
- Reliability of the solder joint and self-alignment of the component are **dependent** on the solder volume. Minimum of 150µm stencil thickness is recommended.
- Aperture size of the stencil should be 1:1 **with the pad size**.
- A low residue, “no clean” solder paste **should be used** due to **low mounted height of the component**.

REFLOW PROFILE

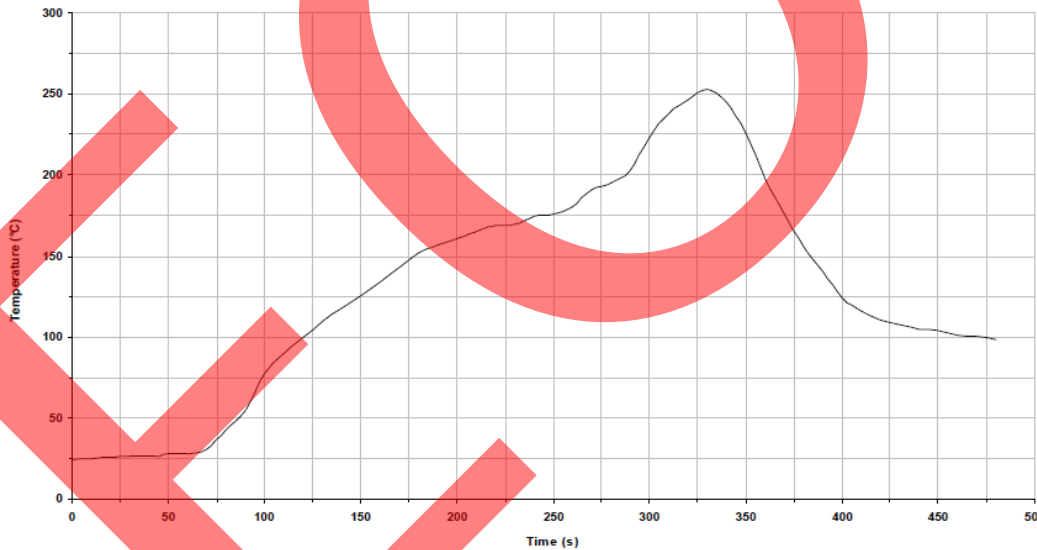

Figure 5. Typical Lead-Free Reflow Solder Profile for ABBTM-NVC-MDCS71

Key features of the profile:

- Initial Ramp = 1-2.5°C/sec to 175°C ±25°C equilibrium
- Equilibrium time = 60 to 180 seconds
- Ramp to Maximum temperature (250°C) = 3°C/sec max.
- Time above liquidus temperature (217°C): 45-90 seconds
- Device absolute maximum reflow temperature: 255°C

Low Power Bluetooth Module (supporting CSRmesh)

ABBTM-NVC-MDCS71-MESH

 RoHS/RoHS II compliant



19.5 x 12.5 x 2.4 mm SMT

PHYSICAL INTERFACES

Layout Guideline

It is strongly recommended to use good layout practices to ensure proper operation of the module. Placing copper or any metal near antenna deteriorates its operation by having effect on the matching properties. Metal shield around the antenna will prevent the radiation and thus metal case should not be used with the module. Use grounding vias separated maximum 3 mm apart at the edge of grounding areas to prevent RF penetrating inside the PCB and causing an unintentional resonator. Use GND vias all around the PCB edges. Figure 4 illustrates recommended PCB design around the antenna of ABBTM-NVC-MDCS71 when the module is placed at the edge of a PCB.

Do not place copper on the top layer under the module, as shown in Figure 6. The module has vias on the area shown, which can cause short circuit if there is copper underneath. Any metal placed closer than 20 mm in any direction from the antenna changes the matching properties and thus will considerably deteriorate the RF performance of the module.

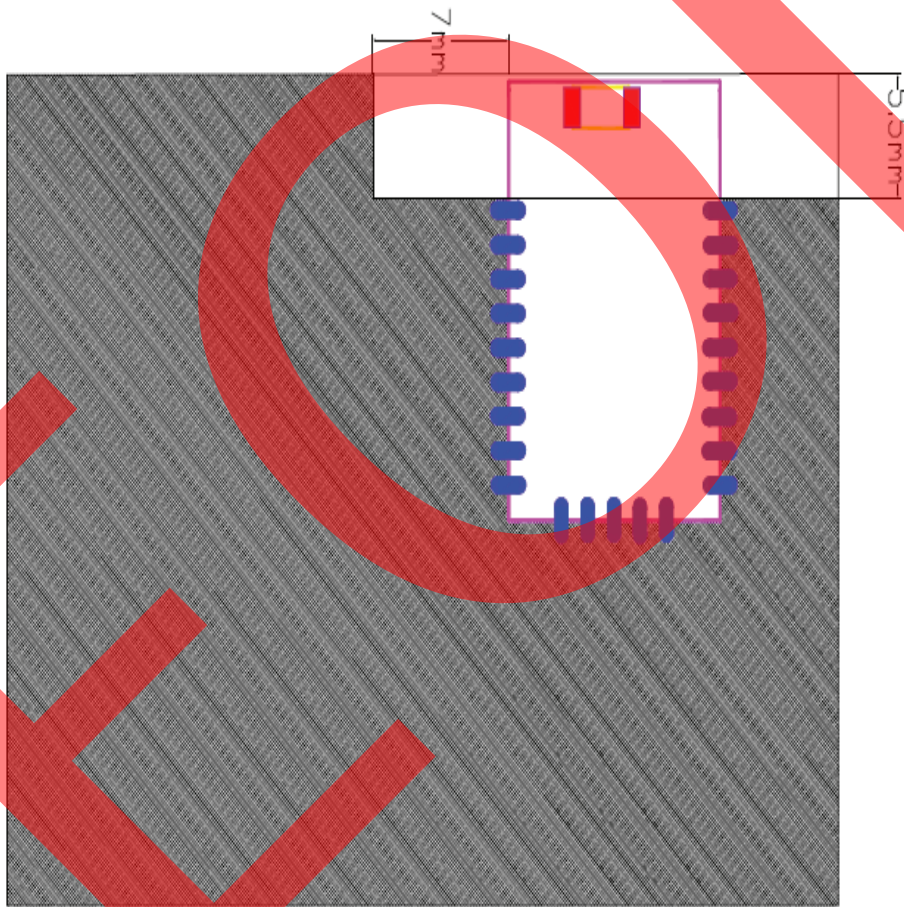

Figure 6. Placement of the Module on a Main Board

Low Power Bluetooth Module (supporting CSRmesh)

ABBTM-NVC-MDCS71-MESH

 RoHS/RoHS II compliant



19.5 x 12.5 x 2.4 mm SMT

OUTLINE DIMENSIONS

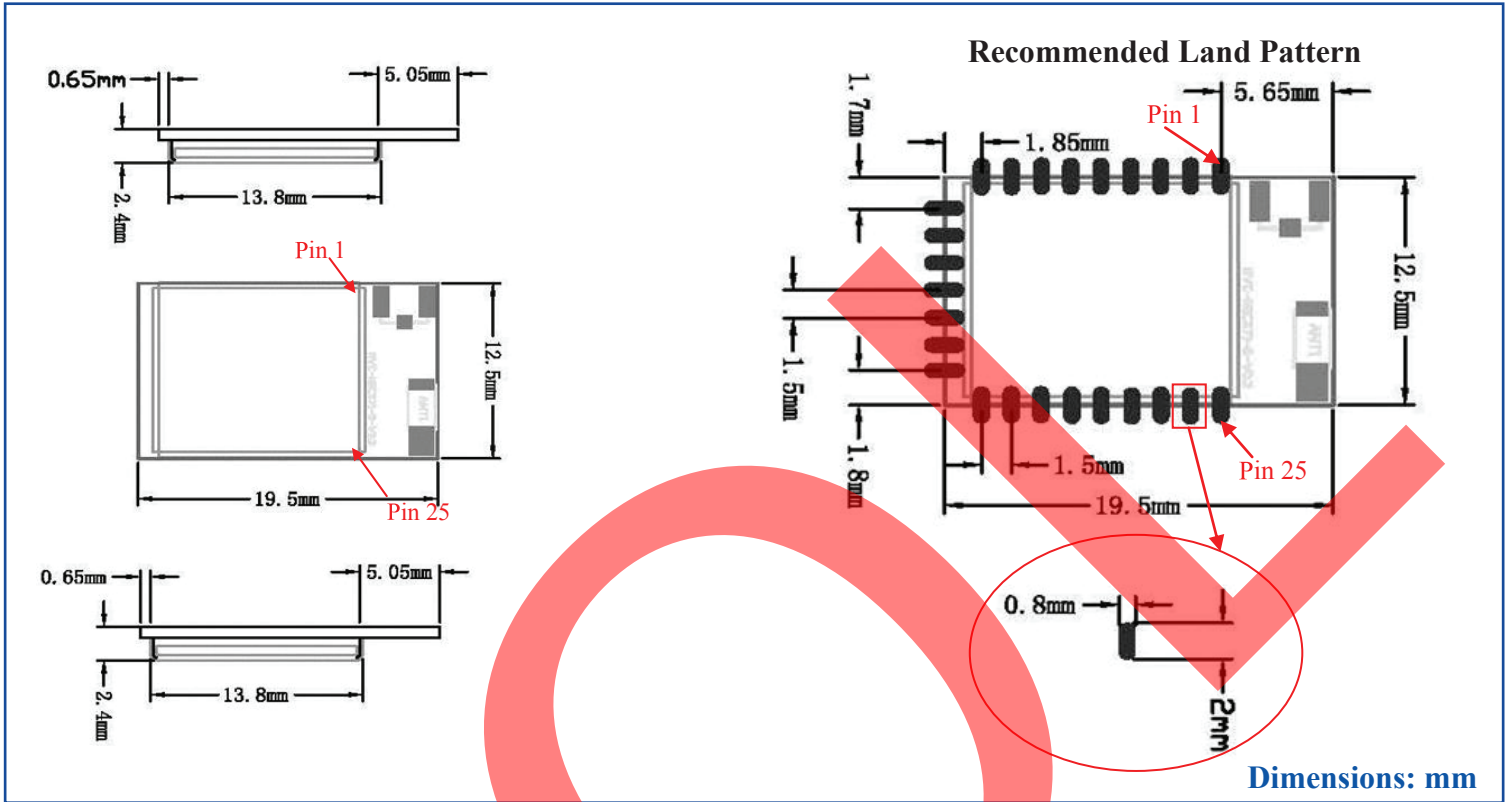

TAPE & REEL:

80pcs/tray

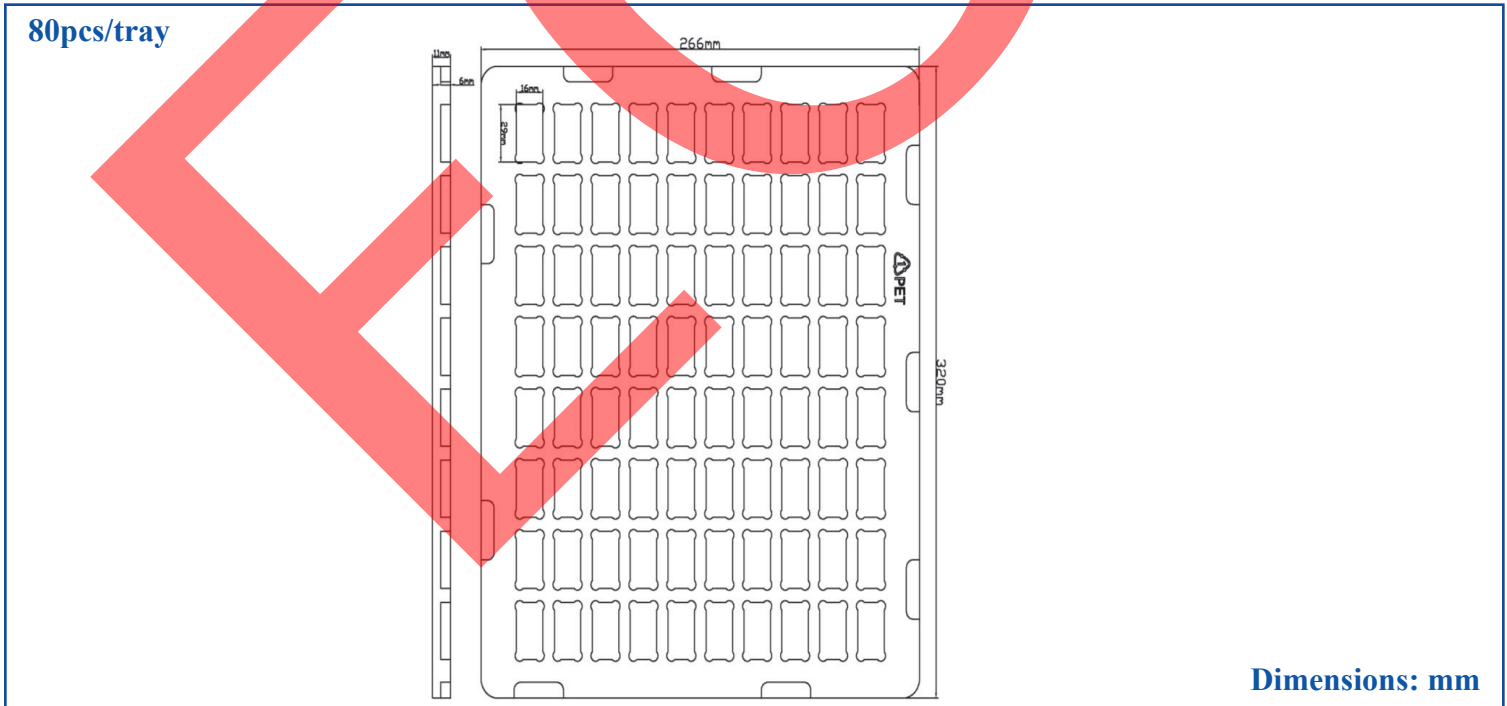

ATTENTION: Abracon Corporation's products are COTS – Commercial-Off-The-Shelf products; suitable for Commercial, Industrial and, where designated, Automotive Applications. Abracon's products are not specifically designed for Military, Aviation, Aerospace, Life-dependant Medical applications or any application requiring high reliability where component failure could result in loss of life and/or property. For applications requiring high reliability and/or presenting an extreme operating environment, written consent and authorization from Abracon Corporation is required. Please contact Abracon Corporation for more information.

ABRACON IS
ISO 9001:2008
CERTIFIED



2 Faraday, Suite# B | Irvine | CA 92618 **Revised: 06.29.15**

Ph. 949.546.8000 | Fax. 949.546.8001

Visit www.abracon.com for Terms and Conditions of Sale