

## SPECIFICATION

- Part No. : **MA106.C.LB.001**
- Product Name : MA106 GPS/GLONASS/Galileo and Cellular  
2in1 Combination Hercules  
Screw-mount (Permanent mount)
- Feature : Low profile - Height 29 mm and Diameter 49mm  
Heavy duty screw mount  
UV and vandal resistant PC housing  
IP65 Rated Enclosure  
Cellular -Penta Band Antenna  
850/900/1800/1900/2100  
GSM/GPRS/CDMA/EVDO/UMTS/HSPA/WCDMA  
Cellular - 3 Meters Low Loss CFD200 SMA(M)  
GPS/Galileo -1575.42MHz - Two Stage 27dB+ LNA  
GLONASS - 1602MHz - Two Stage 27dB+ LNA  
GPS/GLONASS/Galileo - 3 Meters RG174 SMA(M)  
Cables and connectors are fully customizable  
**RoHS & REACH Compliant**



## **1. Introduction**

The MA106.C GPS/GLONASS/Galileo and Cellular Combination Hercules Antenna is the newest upgraded model of Taoglas' popular Hercules series. It is a combination 2in1 high performance GPS/GLONASS/Galileo and penta-band cellular antenna solution for the most reliable asset tracking and remote monitoring. The GPS/GLONASS/Galileo antenna and LNA have been optimized to provide excellent performance.

The penta-band cellular antenna delivers high efficiency at all common 3G/2G bands worldwide, making it ideal for use on GSM, GPRS, and CDMA systems.

Durable UV and robust PC housing is IP65 rated, resistant to vandalism and direct attack. At only 29 mm in height, it complies with the latest EU height restriction directives for roof-mounted objects, with a diameter of 49 mm. It is designed to be covert and not catch on tree branches.

The Hercules can be mounted on metal or non-metal structures as it has a metal ground-plane base integrated inside. A waterproof closed cell foam seal under the base adheres to the surface it is mounted on and can stretch to fit curved surfaces typical on vehicles, preventing water from penetrating any mounting hole.

## 2. Specification

ELECTRICAL CELLULAR						
Standard	CLR	GSM	DCS (AWS)	PCS	IMT (AWS)	
Band (MHz)	850	900	1800	1900	2100	
Frequency (MHz)	824-896	880-960	1710-1880	1850-1990	1920 – 2170	
Return Loss (dB)						
Cable length (meter)	0.3	-6.5	-6.0	-8	-7	-5
	1.0	-9.5	-8	-16	-17	-15
	2.0	-10	-9	-21	-20	-18
	3.0	-13	-11	-21	-21	-19
	5.0	-14	-14	-25	-25	-23
Efficiency (%)						
Cable length (meter)	0.3	38	54	54	58	50
	1.0	31	35	42	36	31
	2.0	23	20	32	23	21
	3.0	25	29	22	23	18
	5.0	11	11.5	11	12	11
Peak Gain (dBi)						
Cable length (meter)	0.3	2.0	3.3	3.6	4.0	3.0
	1.0	1.2	1.3	1.8	2	1.2
	2.0	0.5	-0.35	1.5	0	-0.1
	3.0	0.1	1.6	0.1	0.6	-0.9
	5.0	-2.5	-2.4	-3.0	-2.3	-2.0
Polarization			Linear			
Impedance			50 Ohms			
Input Power			10 Watts max.			
VSWR			<3.5.0:1			

## ELECTRICAL GPS/GALILEO & GLONASS

Frequency	1574~1610MHz		
Impedance	50 ohm		
VSWR	2.0 Max		
GPS/GALILEO Patch Gain@ Zenith	1575.42MHz:2.5dBi Typ. @zenith		
GLONASS Patch Gain@ Zenith	1602MHz:2.0dBi Typ. @zenith		
Out of Band Rejection	fo = 1592MHz fo ± 140 MHz 15dB Min.		
Input Voltage	Min:1.8V	Typ. 3.0V	Max:5.5V
Total Gain @ Zenith	22dB	28dB	31dB
Current Consumption	5mA	10mA	23mA
Noise Figure	2.6dB	2.6dB	2.9dB

## MECHANICAL

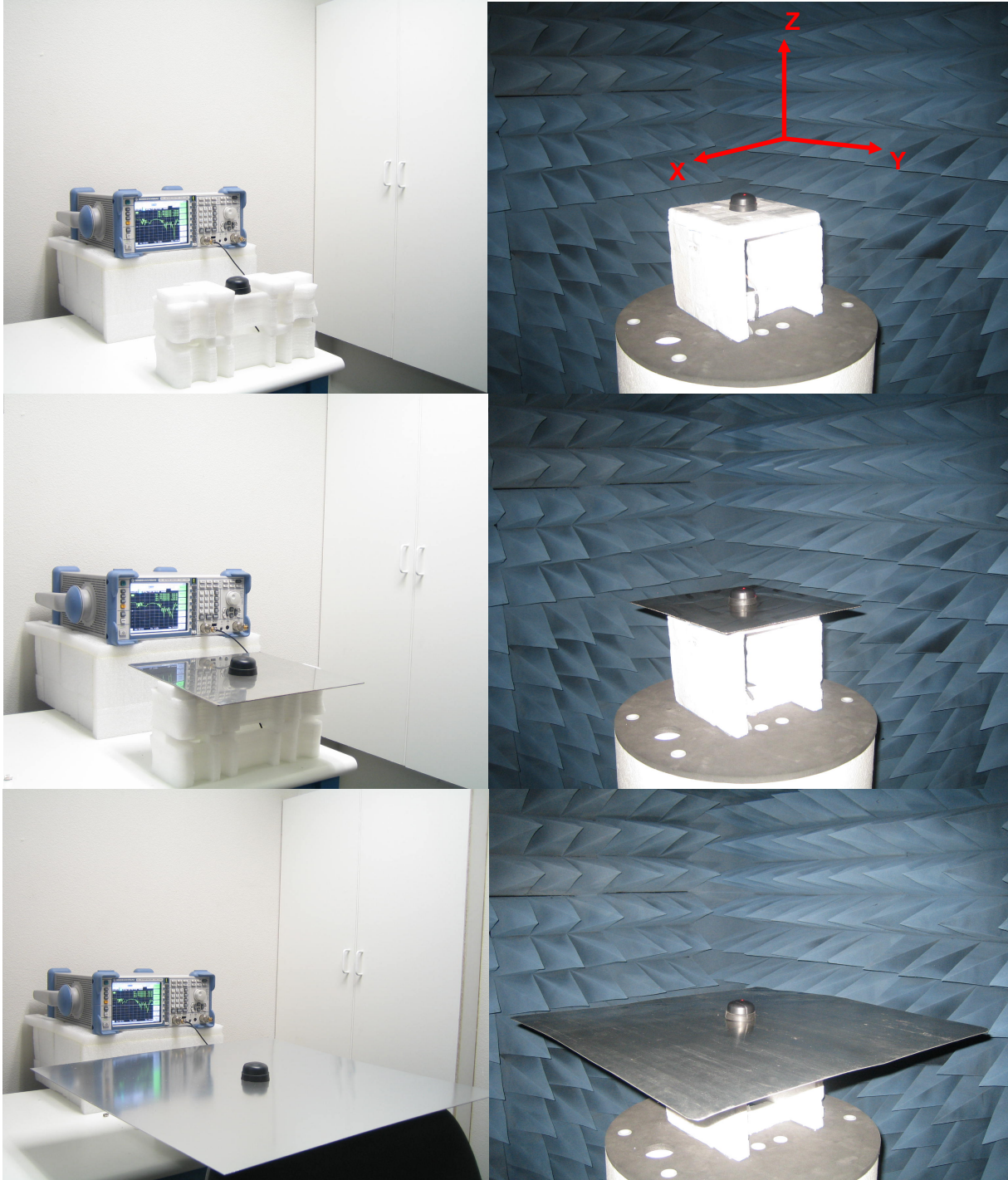
Dimensions	Height 28.5mm x Diameter 49.2mm		
Casing	UV resistant PC		
Base and thread	Nickel plated steel		
Thread diameter	18mm		
Weather proof gasket	CR4305 foam with 3M 9448WC double-side adhesive		
Cable pull	8 Kgf		

## ENVIRONMENTAL

Corrosion	5% NaCl for 48hrs - Nickel plated steel base and thread
Temperature Range	-40°C to +85°C
Thermal Shock	100 cycles -40°C to +80°C
Humidity	Non-condensing 65°C 95% RH
Shock (drop test)	1m drop on concrete 6 axes
Ingress Protection	IP65

\*Note: The return loss, efficiency, and gain measurements in the above table were taken with the antenna mounted on a 30x30 cm metal plate. For specific case performance, refer to the plots below.

### 3. Test Setup



**Figure 1.** MA106 Antenna test setup in free space, 30x30 cm metal plate and 60x60 cm metal plate, R&S ZVL6 VNA (left) and R&S 4100 CTIA 3D Chamber (Right).



## 4. Cellular Antenna Parameters

### 4.1 Return Loss

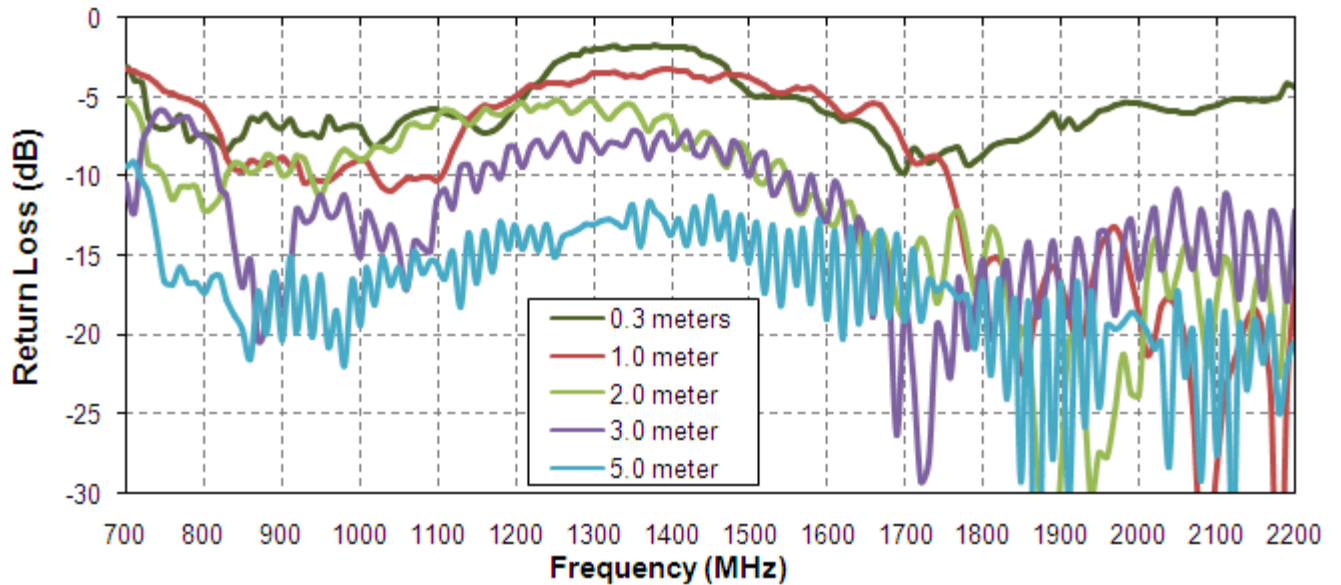


Figure 2. Return Loss of the MA106 antenna in free space.

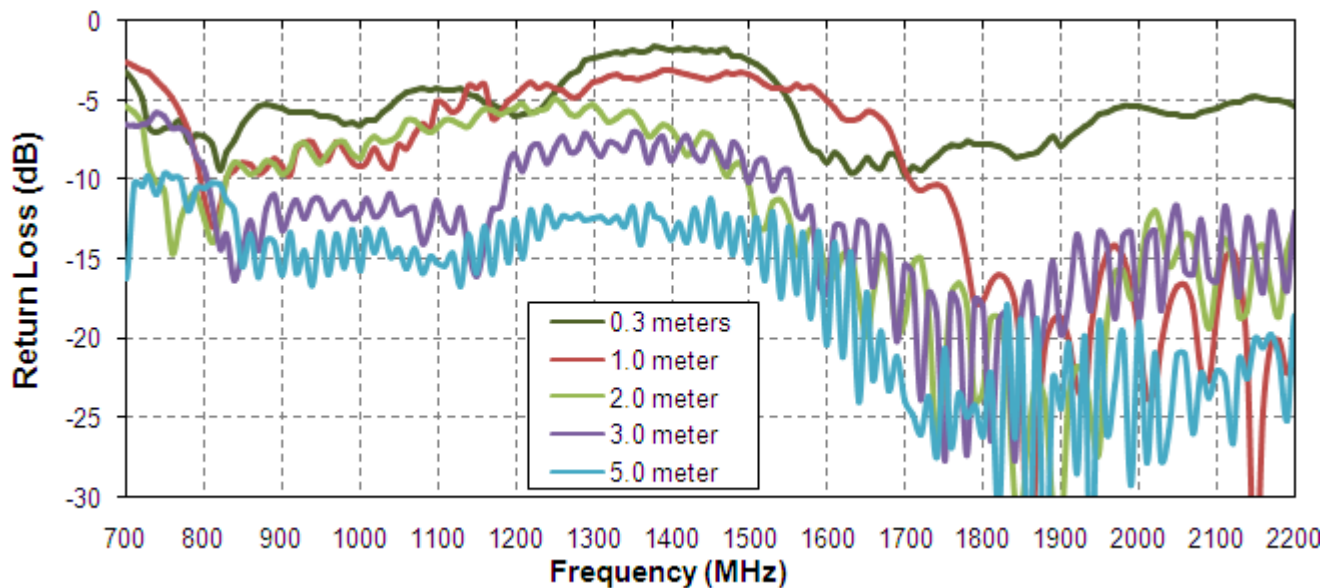
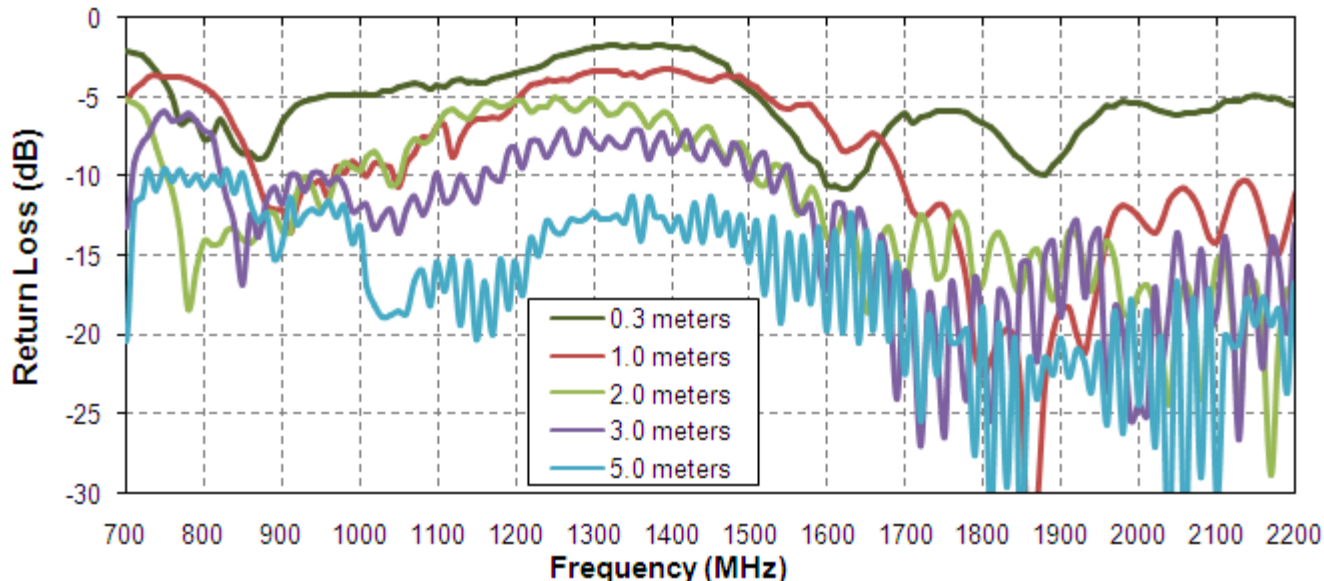


Figure 3. Return Loss of the MA106 antenna on 30\*30cm metal plate.

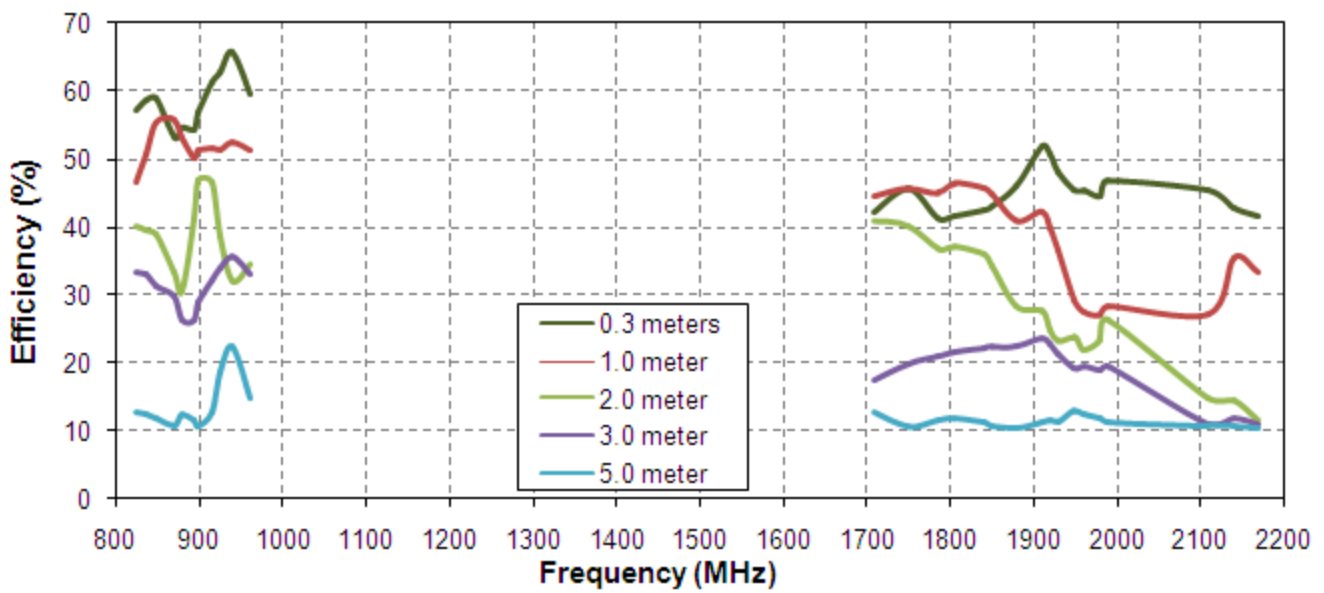


# TAOGLAS®

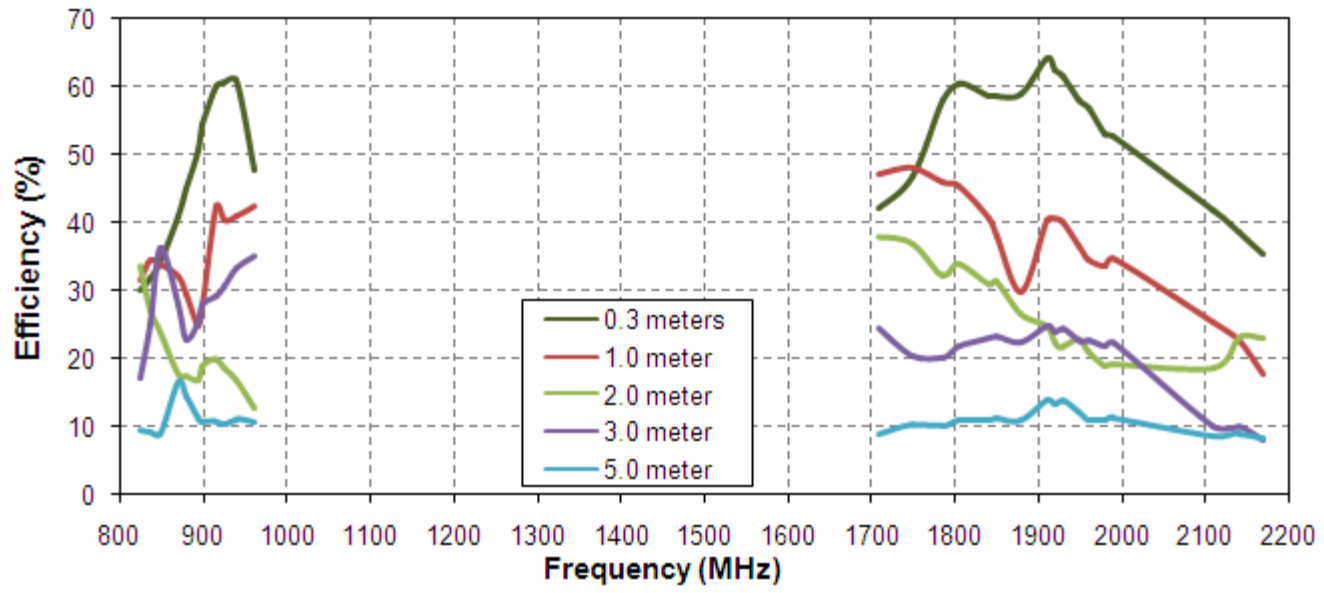


**Figure 4.** Return Loss of the MA106 antenna on 60\*60cm metal plate.

**4.2 Efficiency**

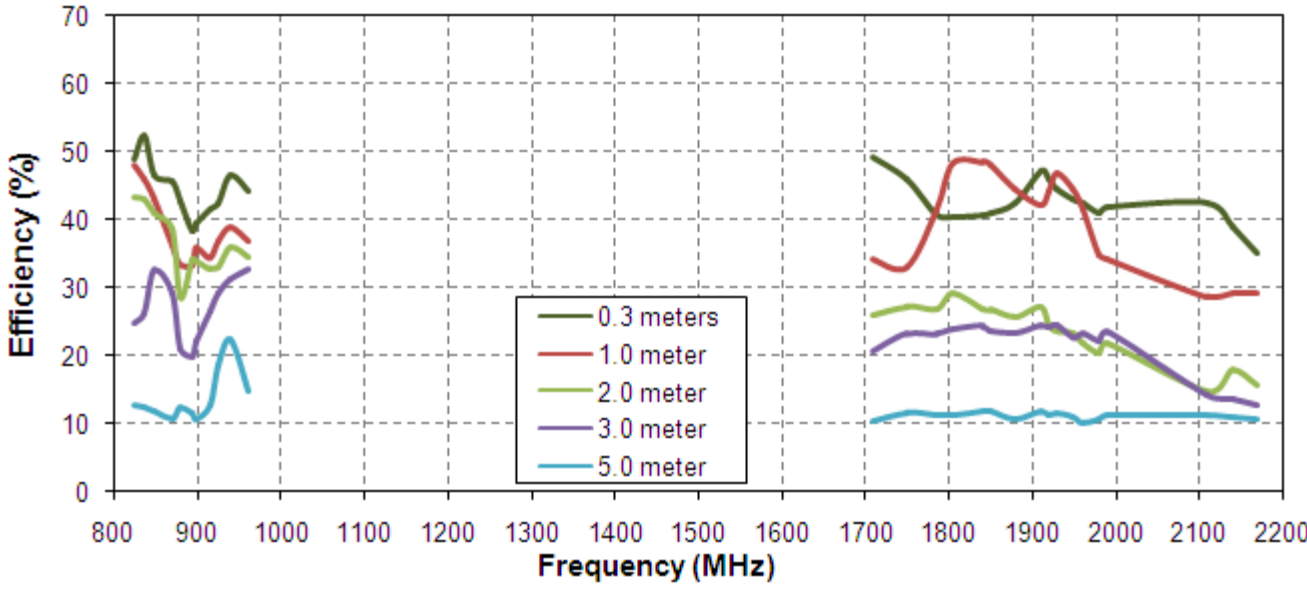


**Figure 5.** Efficiency of the MA106 antenna in free space.



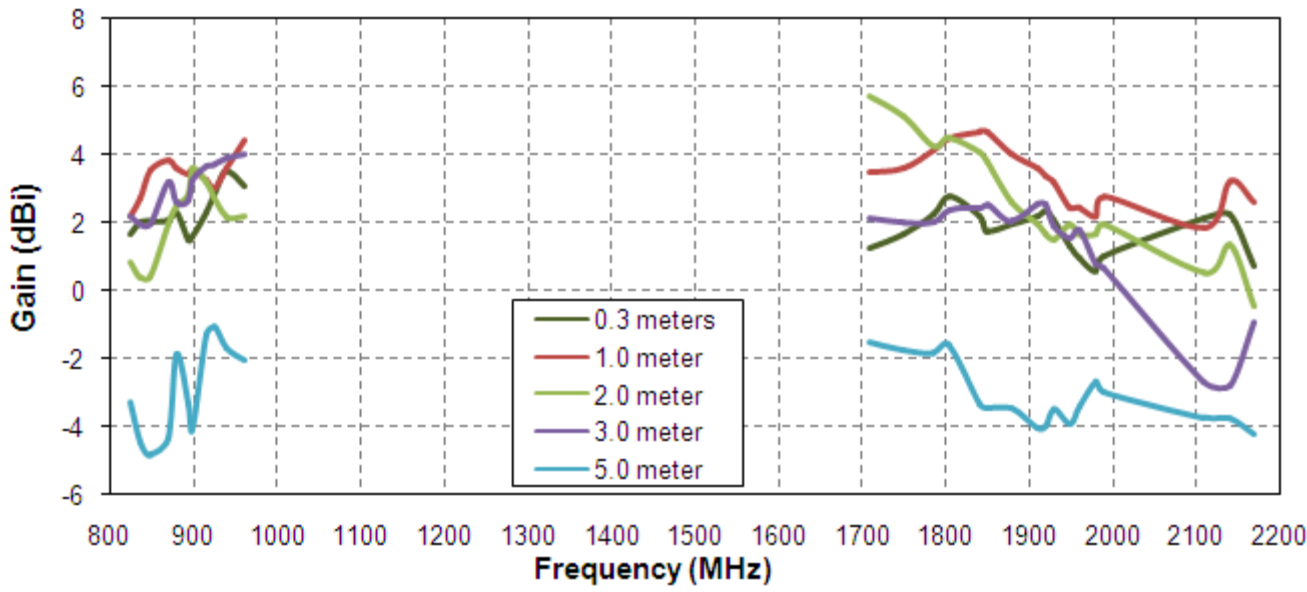
**Figure 6.** Efficiency of the MA106 antenna on 30\*30cm metal plate.



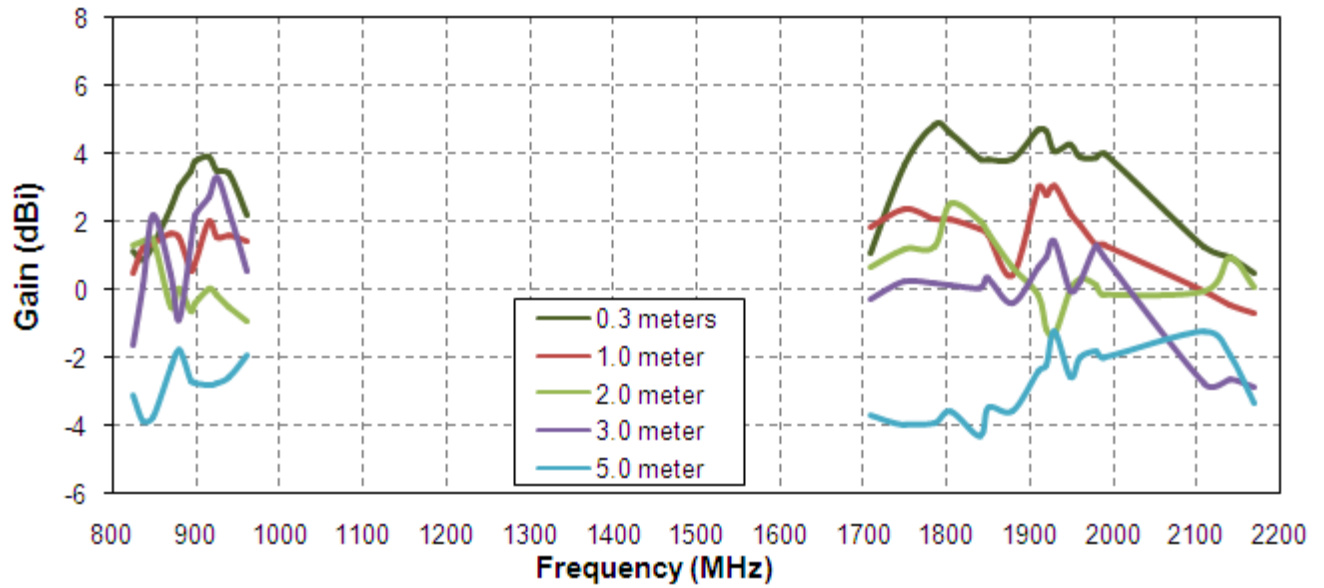


**Figure 7.** Efficiency of the MA106 antenna on 60\*60cm metal plate.

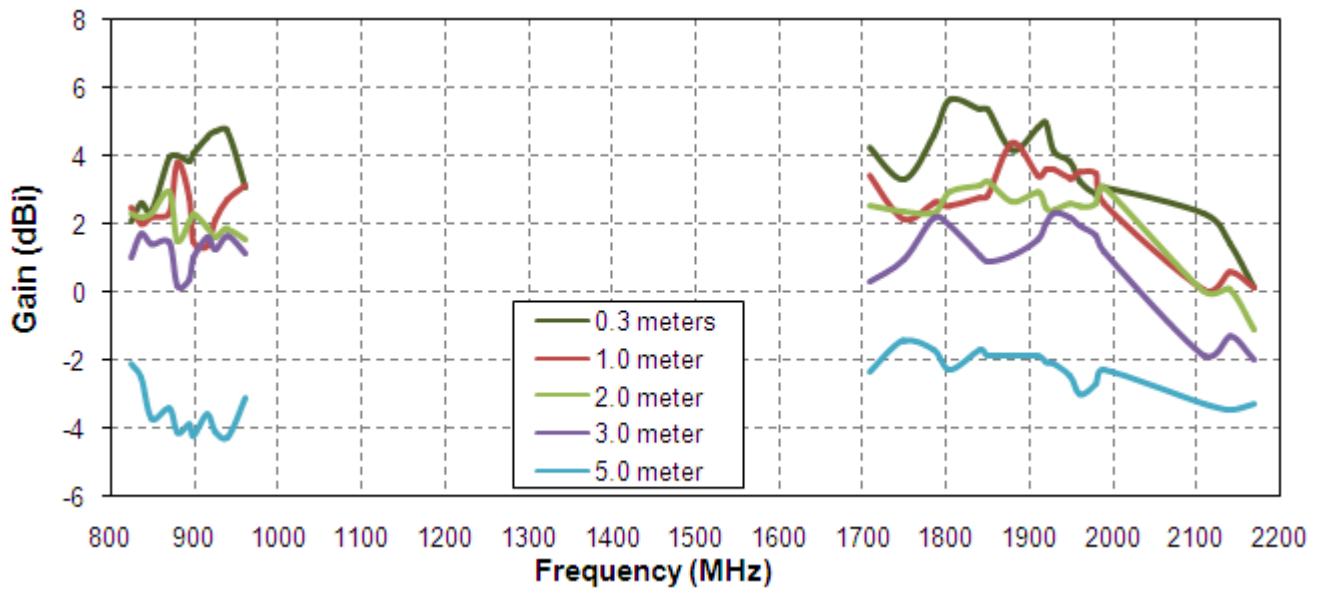
**4.3 Peak Gain**



**Figure 8.** Gain of the MA106 antenna in free space.

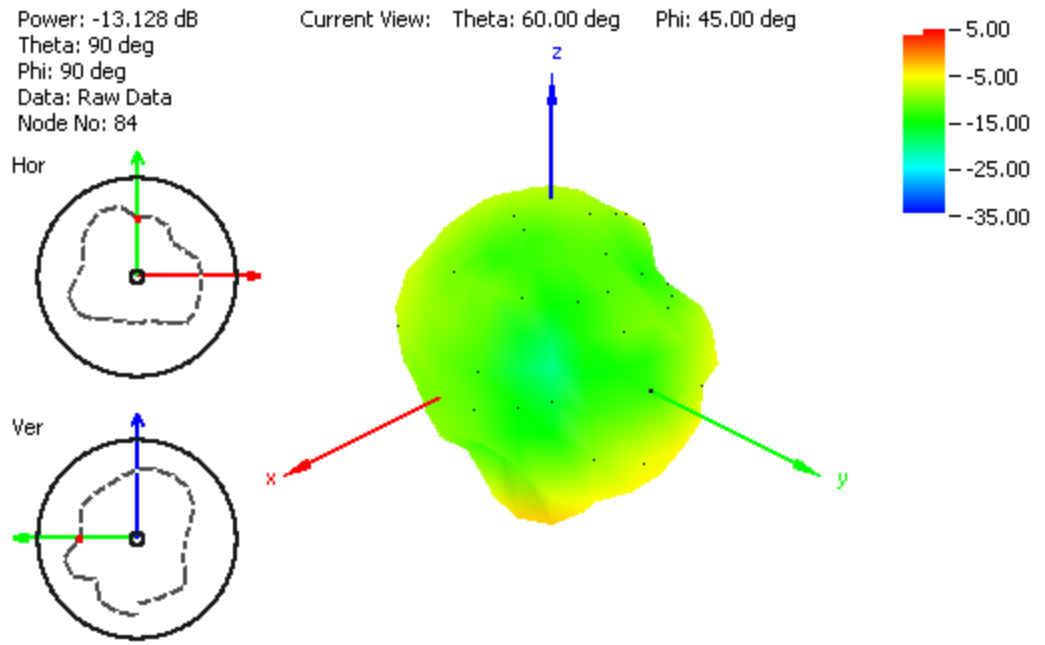


**Figure 9.** Gain of the MA106 antenna on 30\*30cm metal plate.

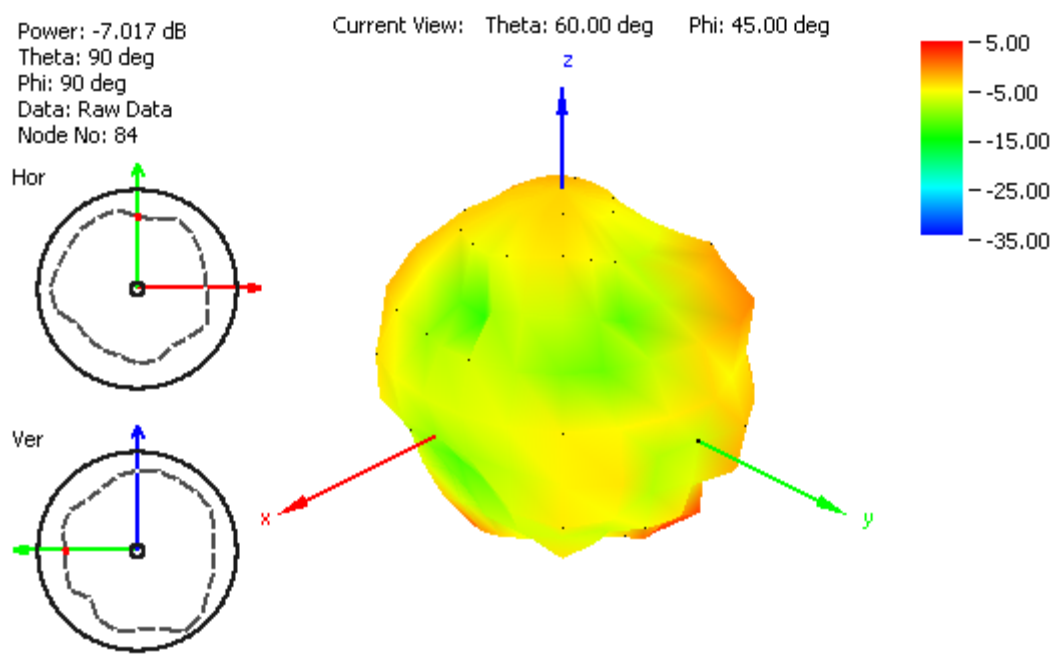


**Figure 10.** Gain of the MA106 antenna on 60\*60cm metal plate.

### 4.4 Radiation pattern



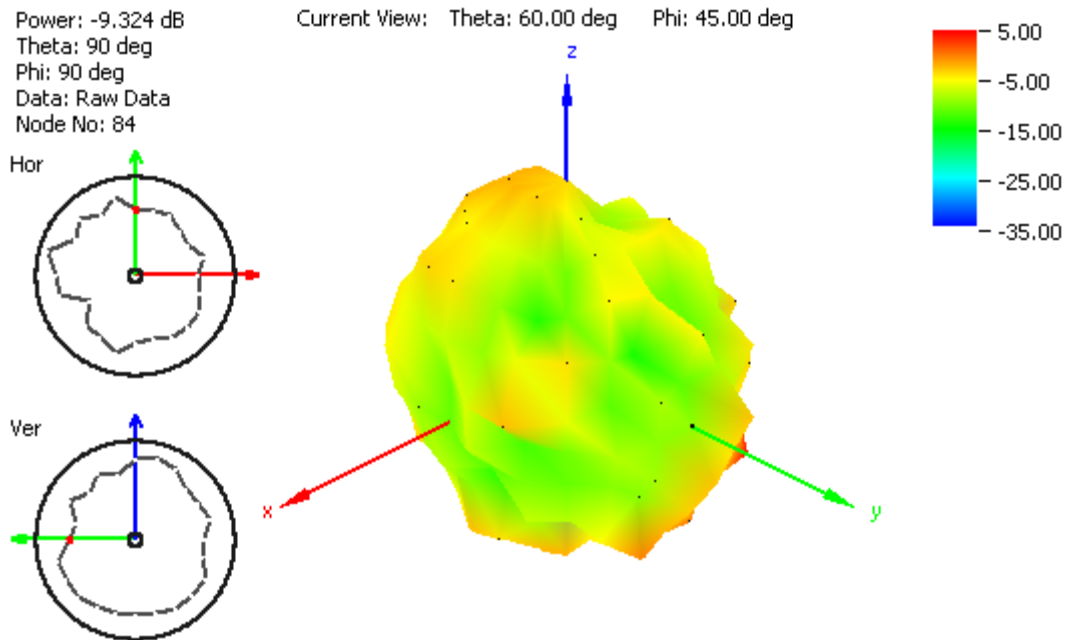
**Figure 11.** Radiation pattern at 849 MHz, Figure 1 as reference (dB), with 2 m RG174 cable and free space.



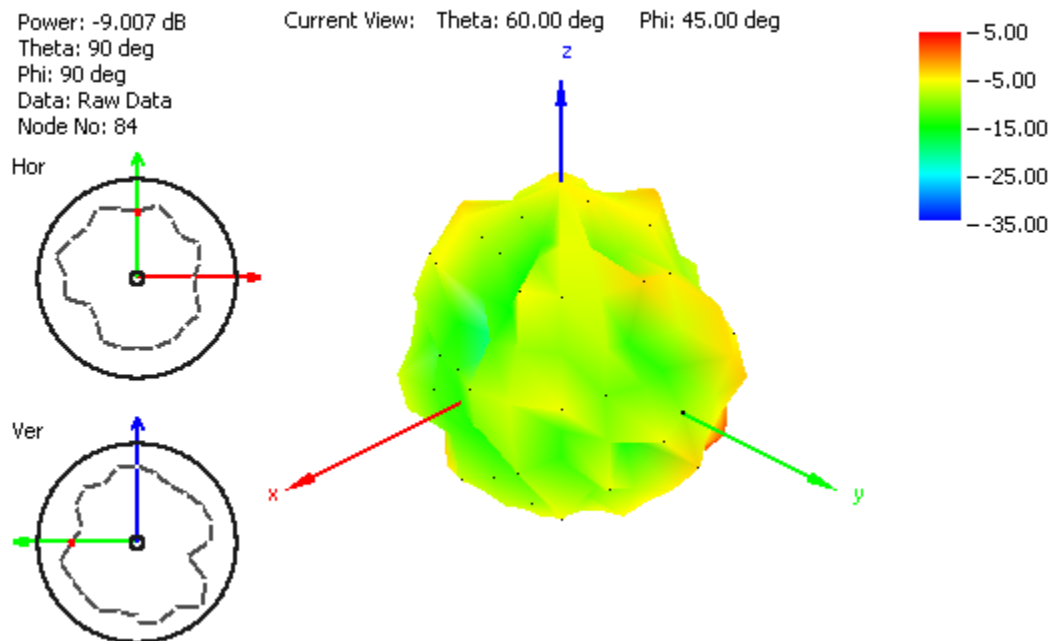
**Figure 12.** Radiation pattern at 915 MHz, Figure 1 as reference (dB), with 2 m RG174 cable and free space.



# TAOGLAS®



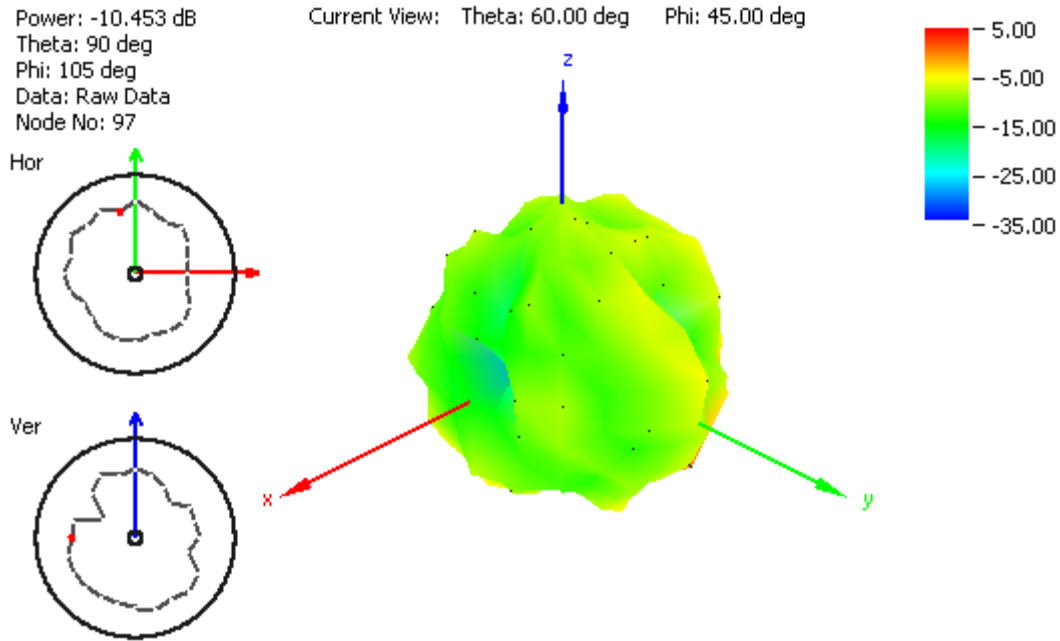
**Figure 13.** Radiation pattern at 1805 MHz, Figure 1 as reference (dB), with 2 m RG174 cable and free space.



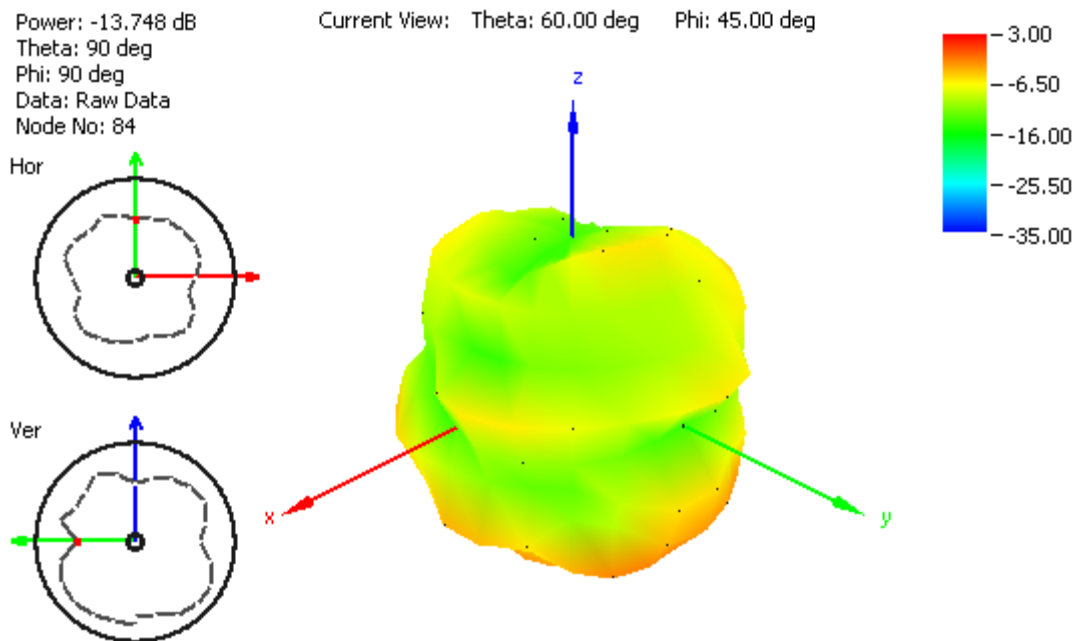
**Figure 14.** Radiation pattern at 1910 MHz, Figure 1 as reference (dB), with 2 m RG174 cable and free space.



# TAOGLAS®



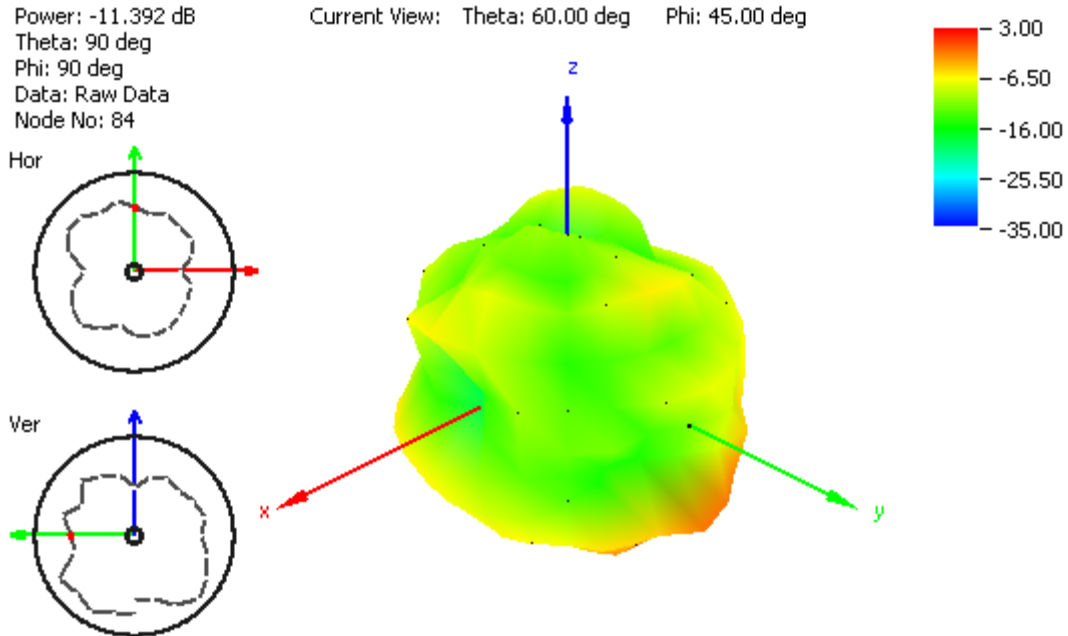
**Figure 15.** Radiation pattern at 2110 MHz, Figure 1 as reference (dB), with 2 m RG174 cable and free space.



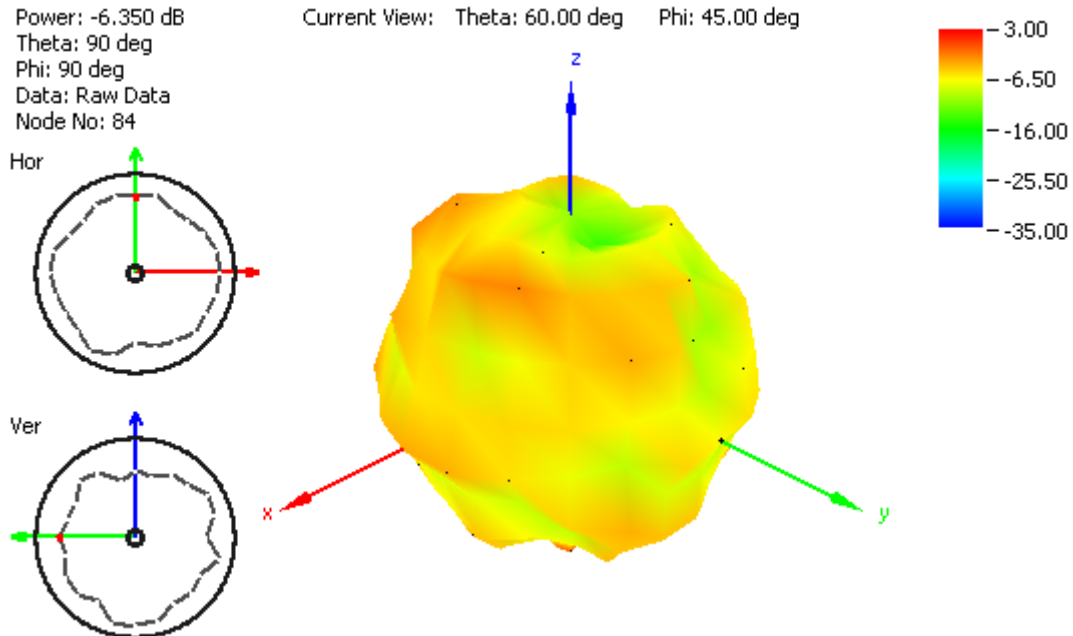
**Figure 16.** Radiation pattern at 849 MHz, Figure 1 as reference (dB), with 2 m RG174 cable and 30x30 cm metal plate.



# TAOGLAS®



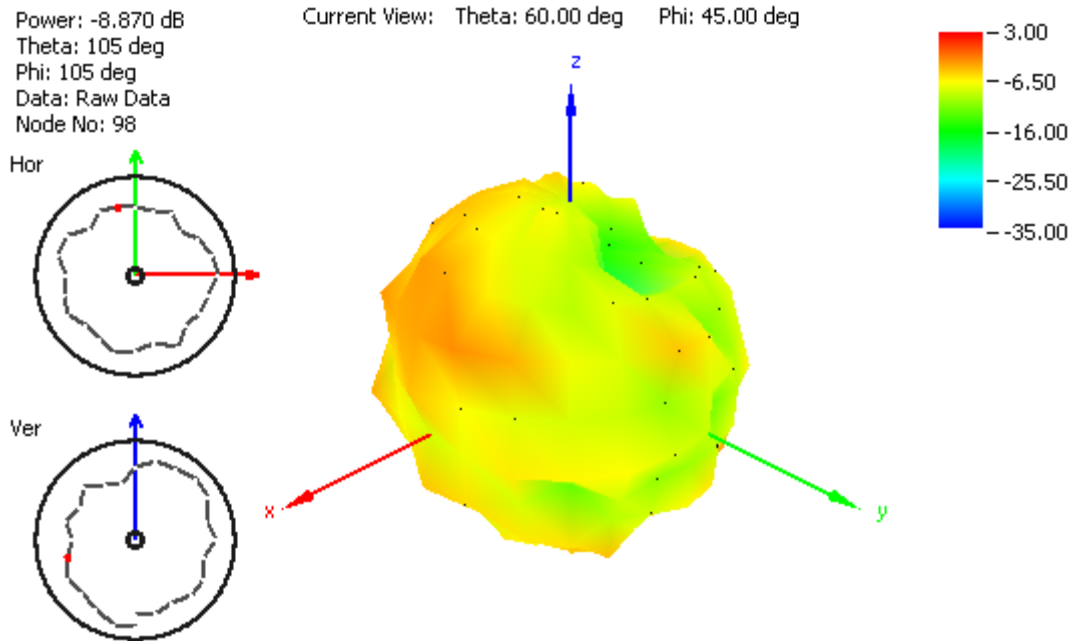
**Figure 17.** Radiation pattern at 915 MHz, Figure 1 as reference (dB), with 2 m RG174 cable and 30x30 cm metal plate.



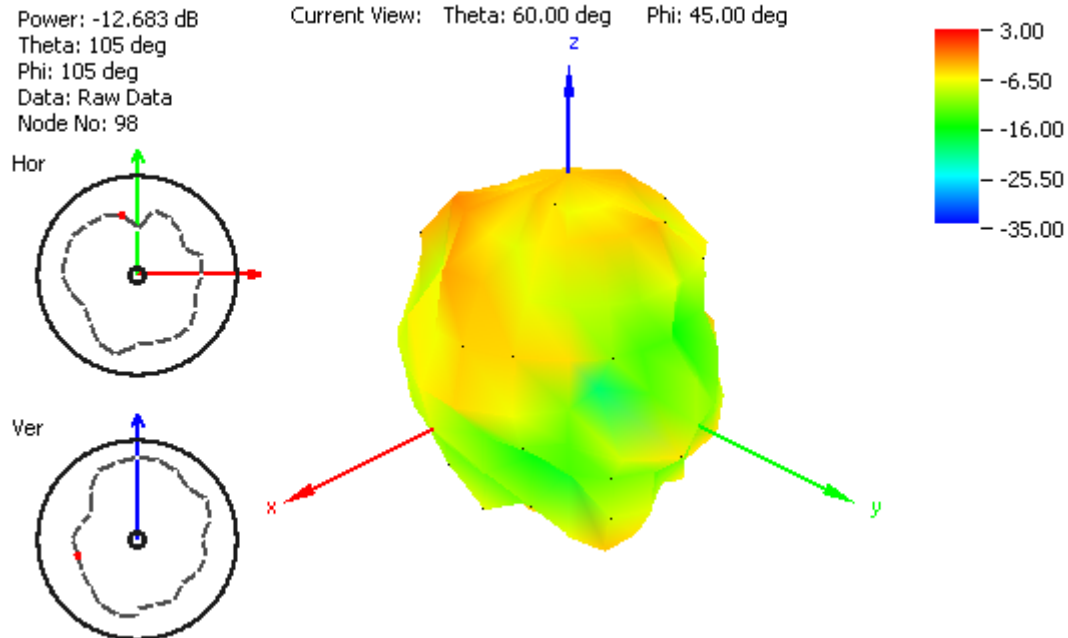
**Figure 18.** Radiation pattern at 1805 MHz, Figure 1 as reference (dB), with 2 m RG174 cable and 30x30 cm metal plate.



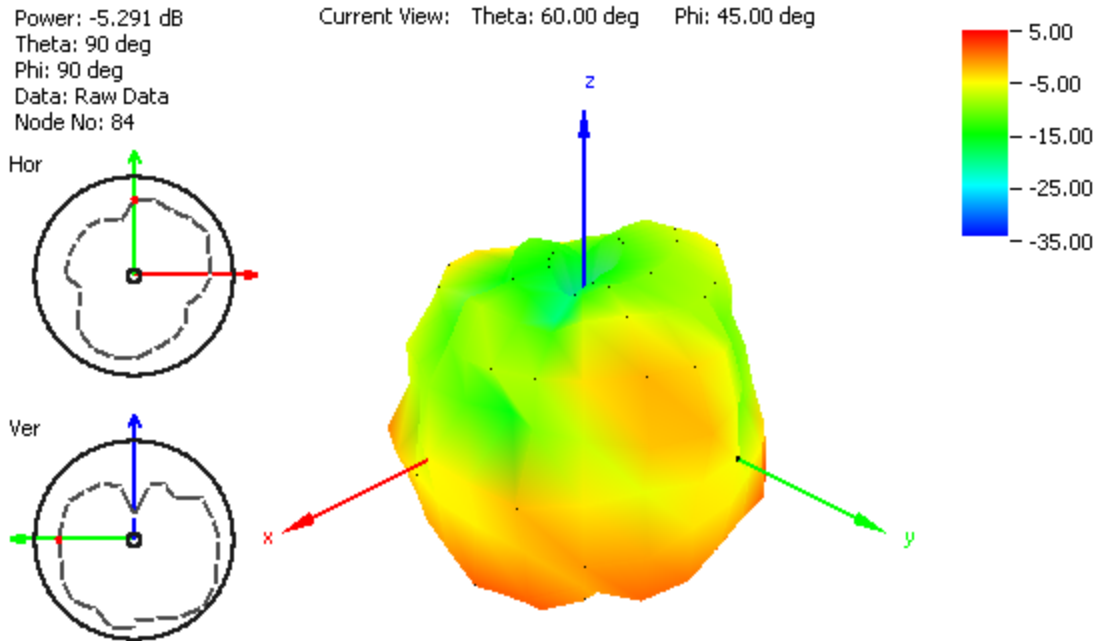
# TAOGLAS®



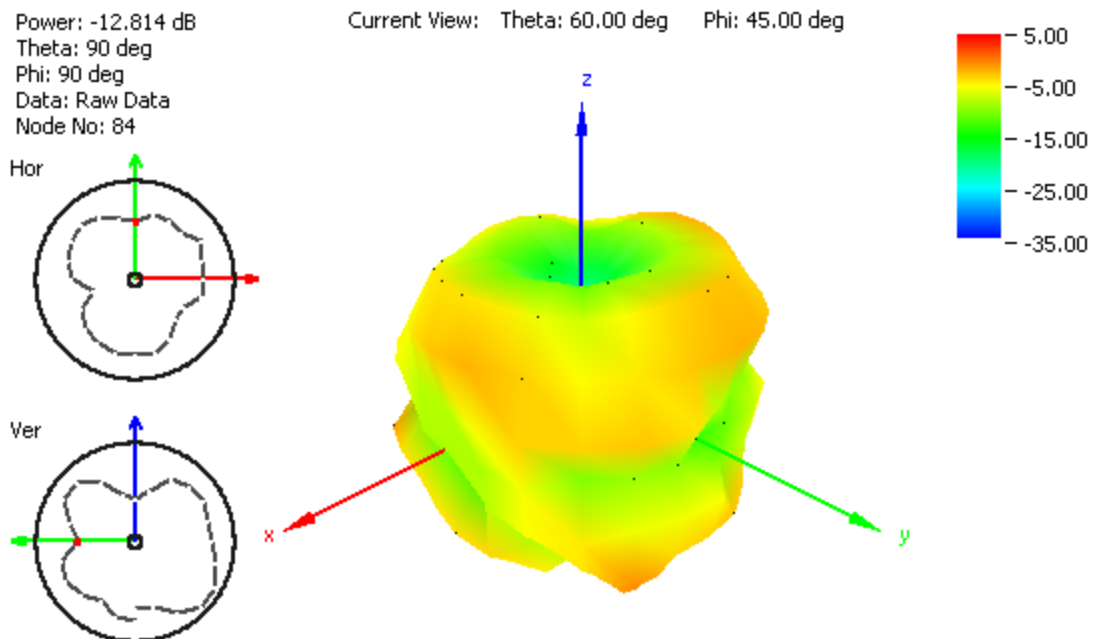
**Figure 19.** Radiation pattern at 1910 MHz, Figure 1 as reference (dB), with 2 m RG174 cable and 30x30 cm metal plate.



**Figure 20.** Radiation pattern at 2110 MHz, Figure 1 as reference (dB), with 2 m RG174 cable and 30x30 cm metal plate.



**Figure 21.** Radiation pattern at 849 MHz, Figure 1 as reference (dB), with 2 m RG174 cable and 60x60 cm metal plate.

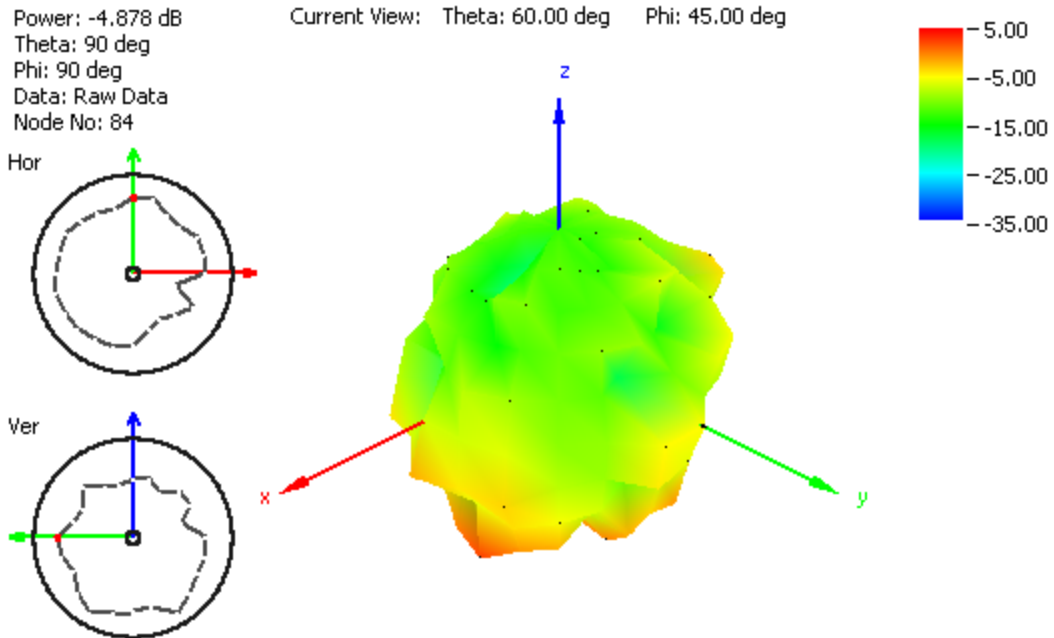


**Figure 22.** Radiation pattern at 915 MHz, Figure 1 as reference (dB), with 2 m RG174 cable and 60x60 cm metal plate.

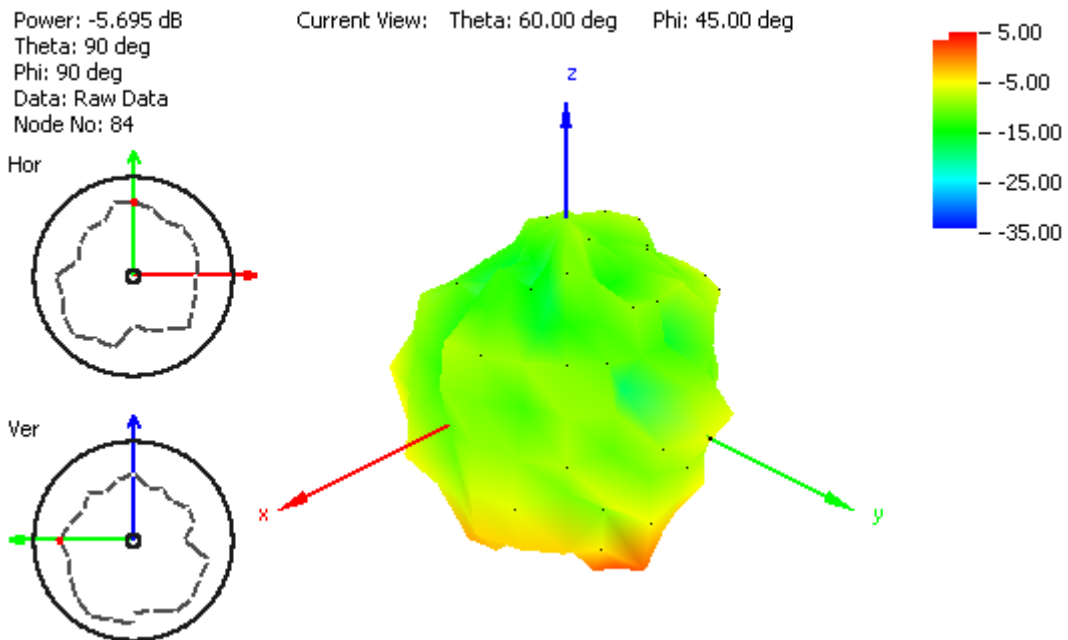




# TAOGLAS®



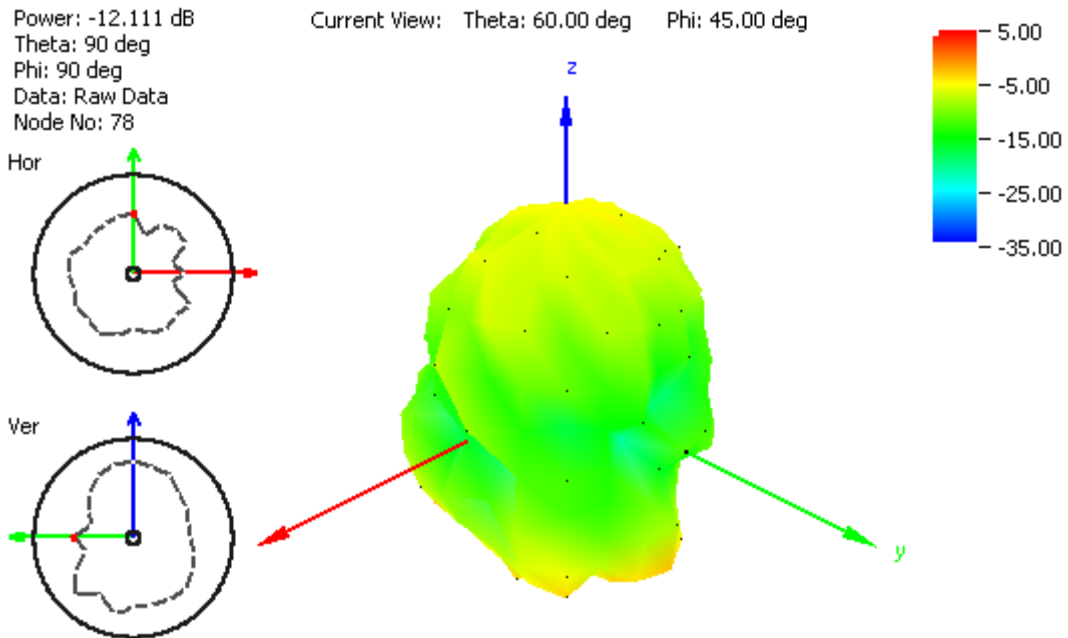
**Figure 23.** Radiation pattern at 1805 MHz, Figure 1 as reference (dB), with 2 m RG174 cable and 60x60 cm metal plate.



**Figure 24.** Radiation pattern at 1910 MHz, Figure 1 as reference (dB), with 2 m RG174 cable and 60x60 cm metal plate.

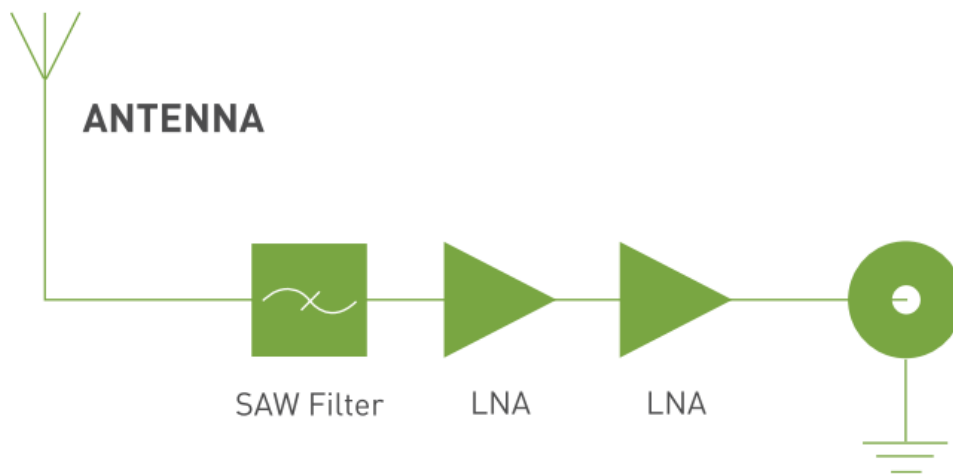


# TAOGLAS®



**Figure 25.** Radiation pattern at 2110 MHz, Figure 1 as reference (dB), with 2 m RG174 cable and 60x60 cm metal plate.

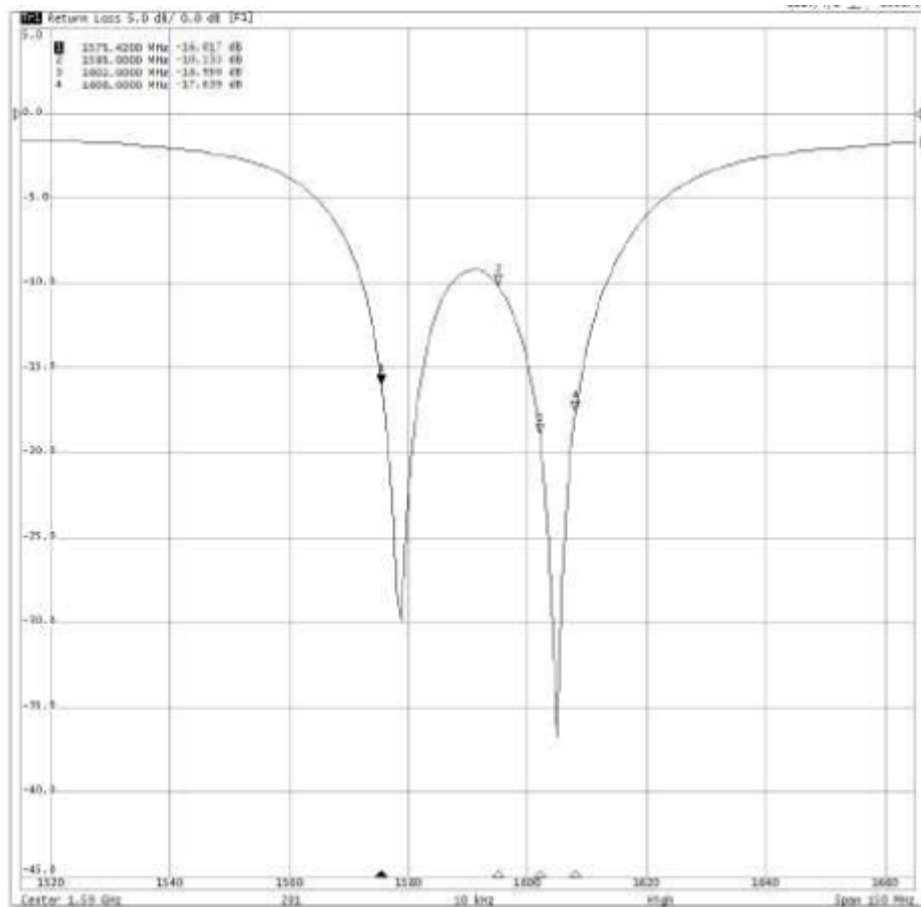
## 5. System Block Diagram





## 6. GPS-GLONASS-GALILEO Passive Antenna Results

### 6.1 Return Loss

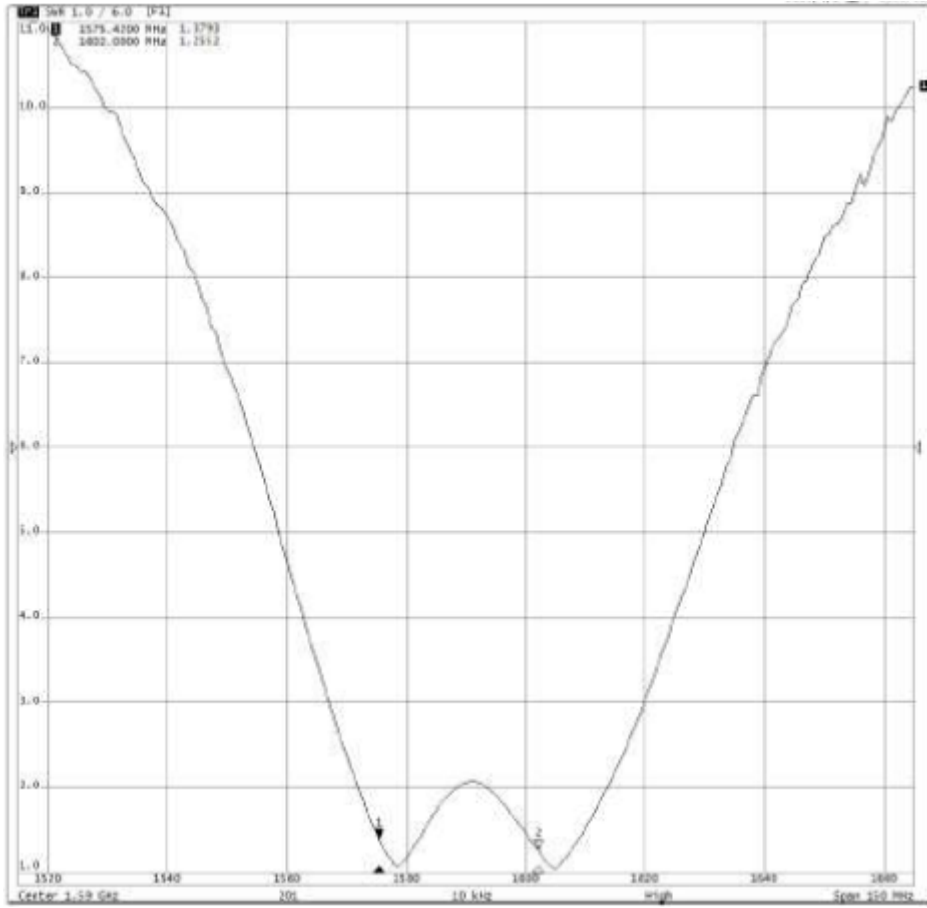


1575.42 MHz - 16.01 dB  
1602.60 MHz - 18.95 dB



# TAOGLAS®

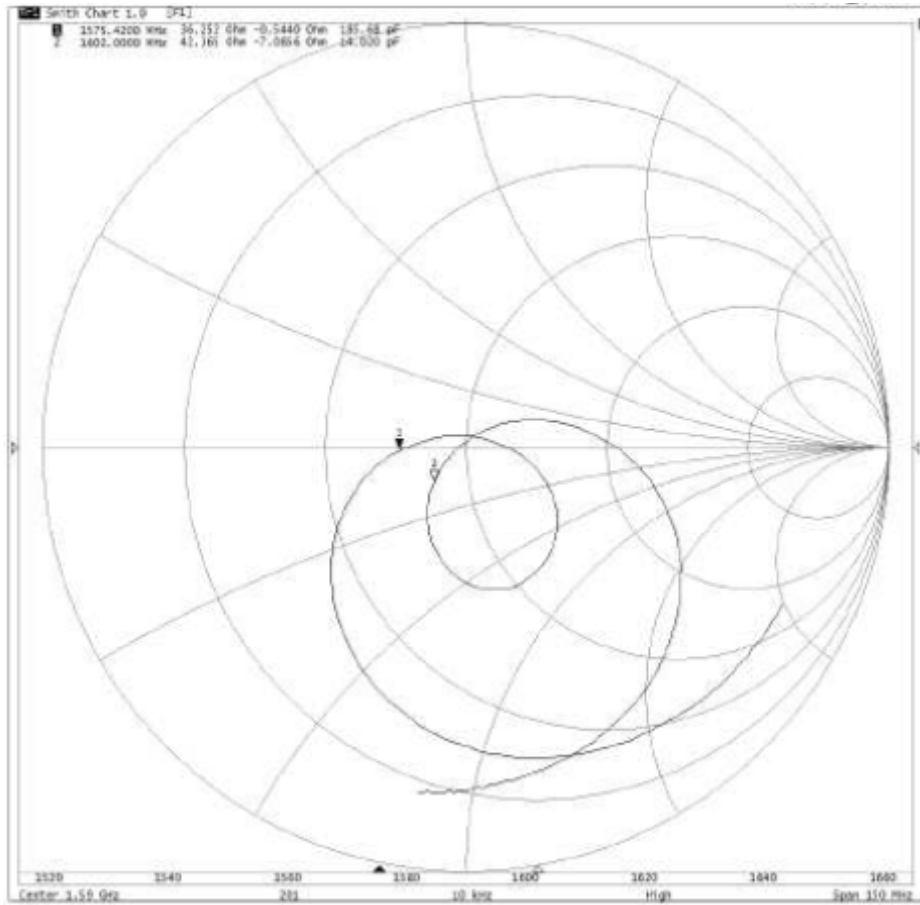
## 6.2 VSWR



1.37 @ 1575.42MHz  
1.25 @ 1602.60MHz



## 6.3 Smith Chart



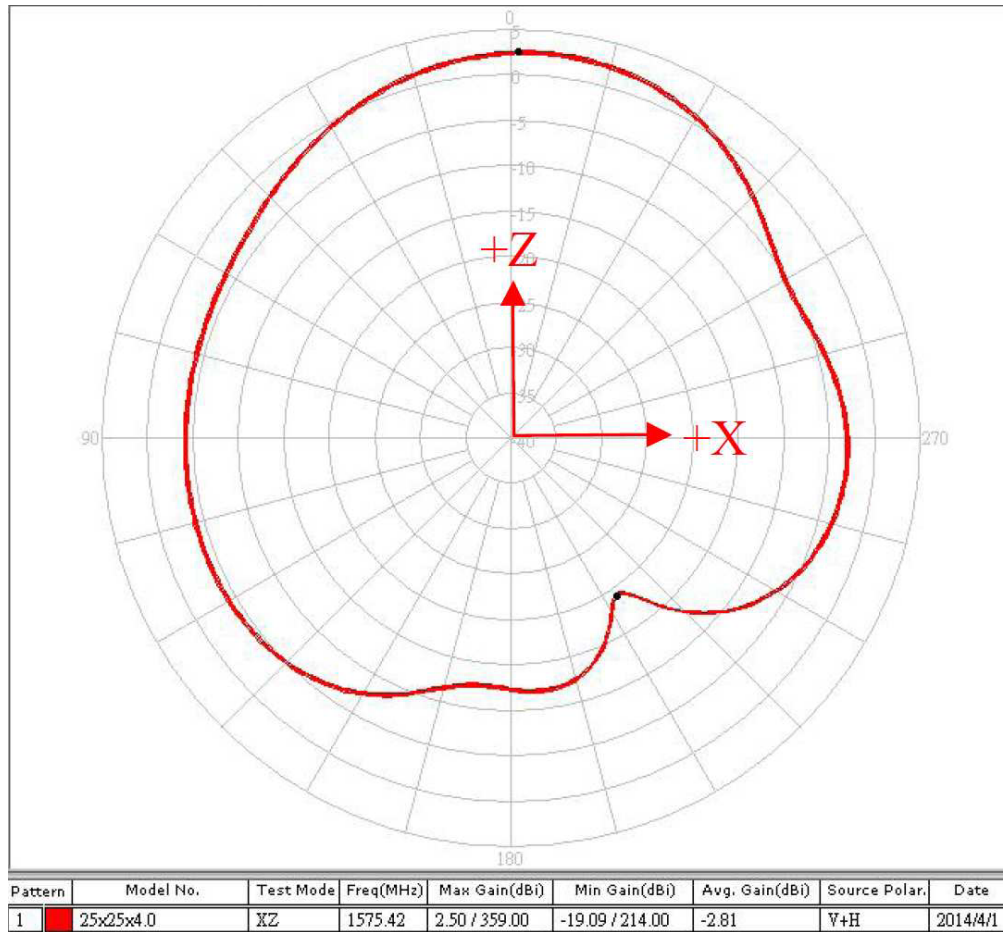
36.52-j0.54 Ohm  
42.36-j7.08 Ohm



# TAOGLAS®

## 6.4 Radiation Patterns

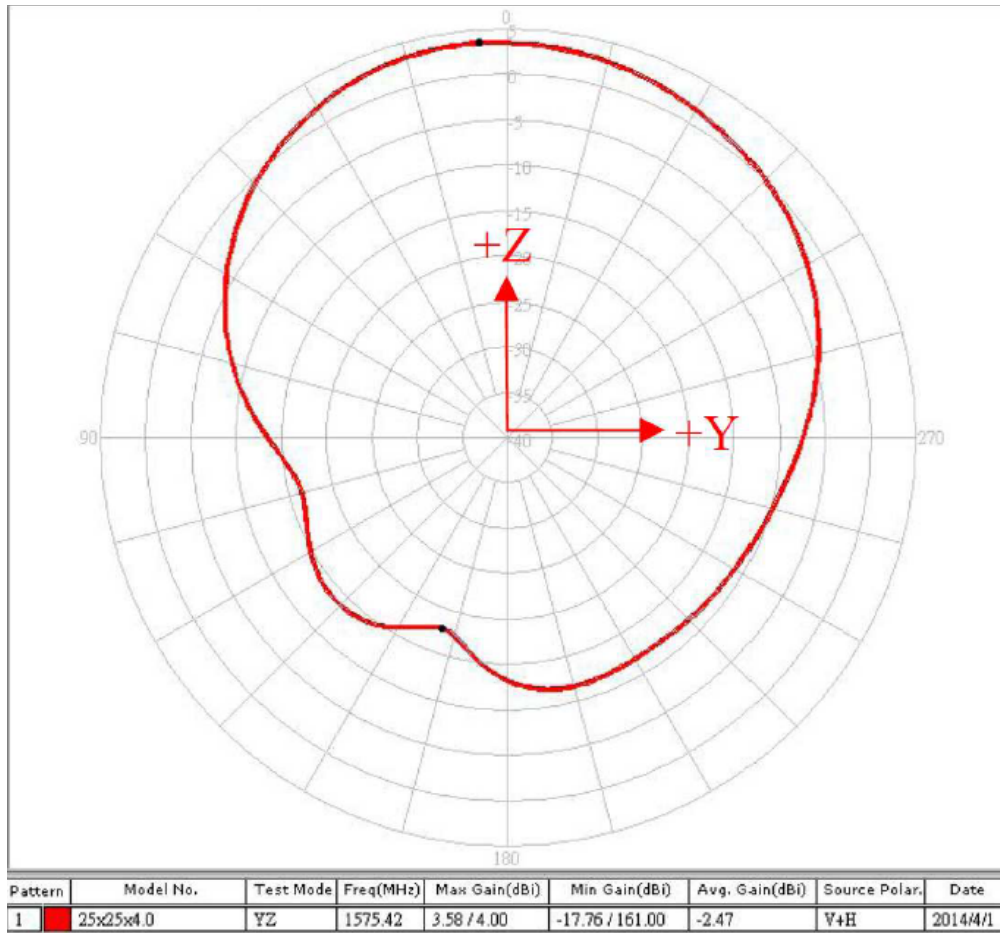
### 6.4.1 1575.42 MHz XZ-Plane





# TAOGLAS®

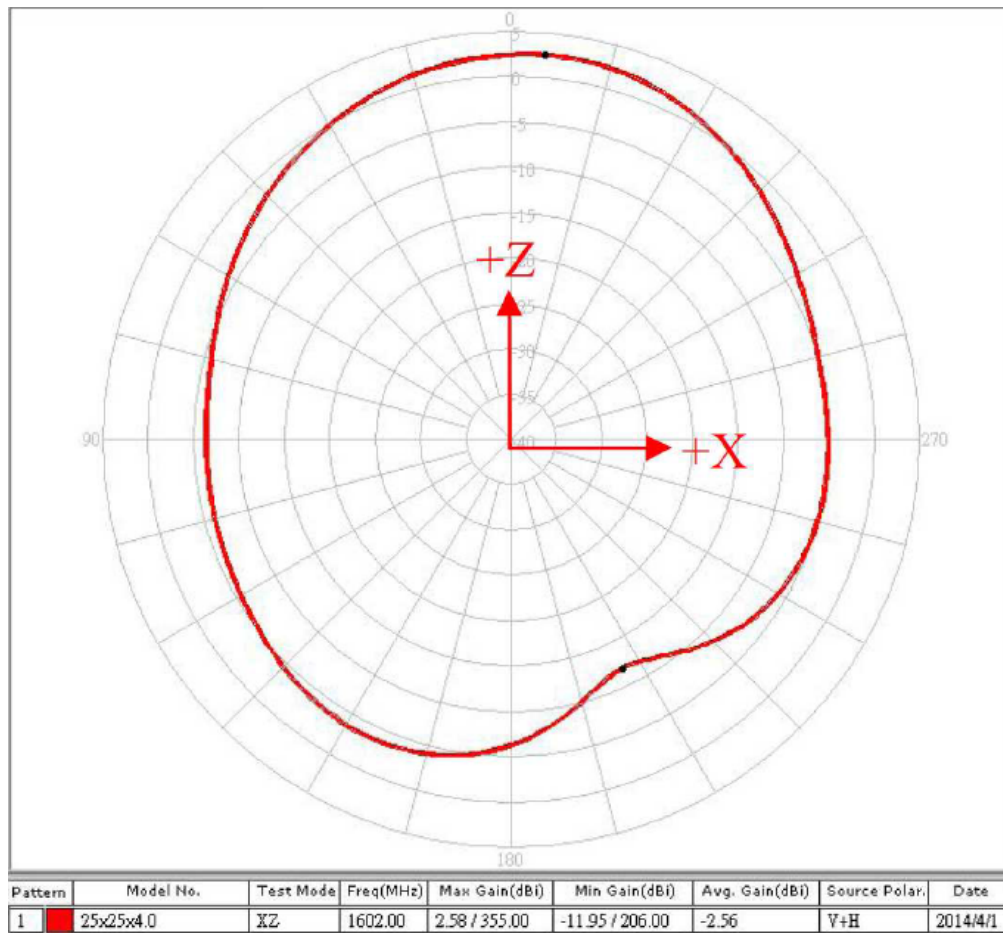
## 6.4.2 1575.42 MHz YZ-Plane





# TAOGLAS®

## 6.4.3 1602 MHz XZ-Plane

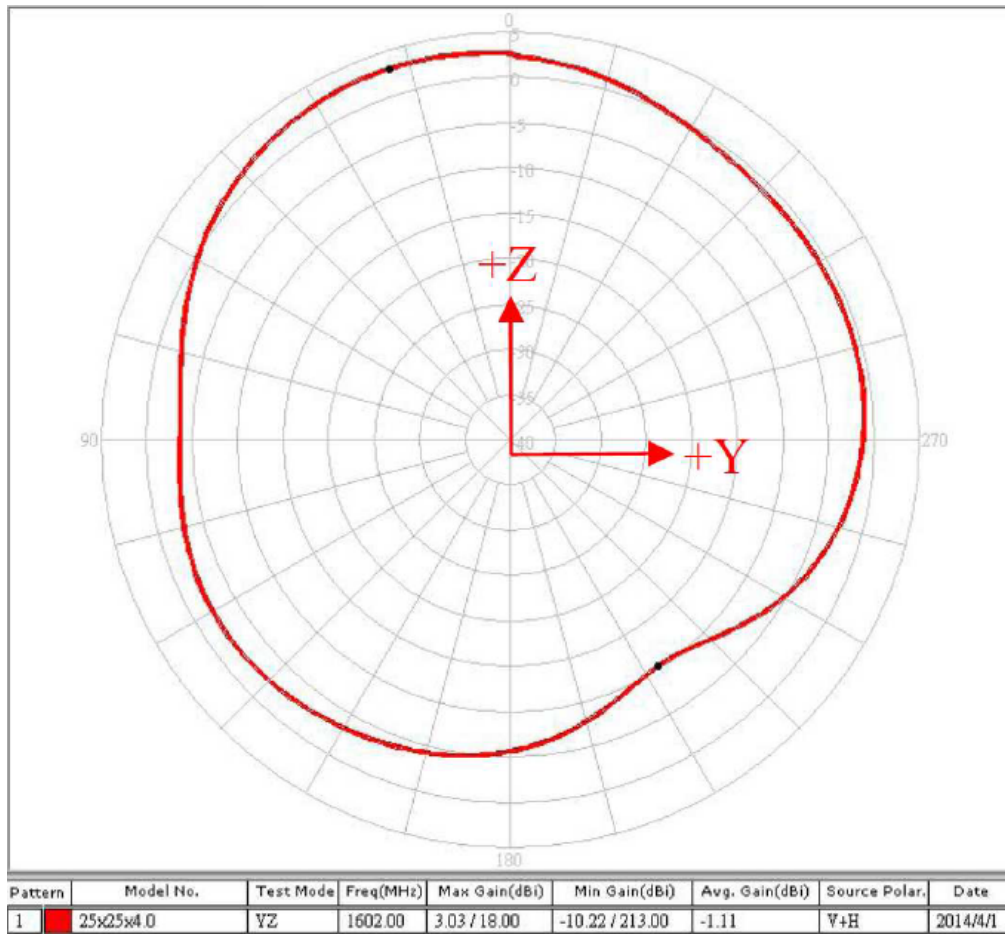






# TAOGLAS®

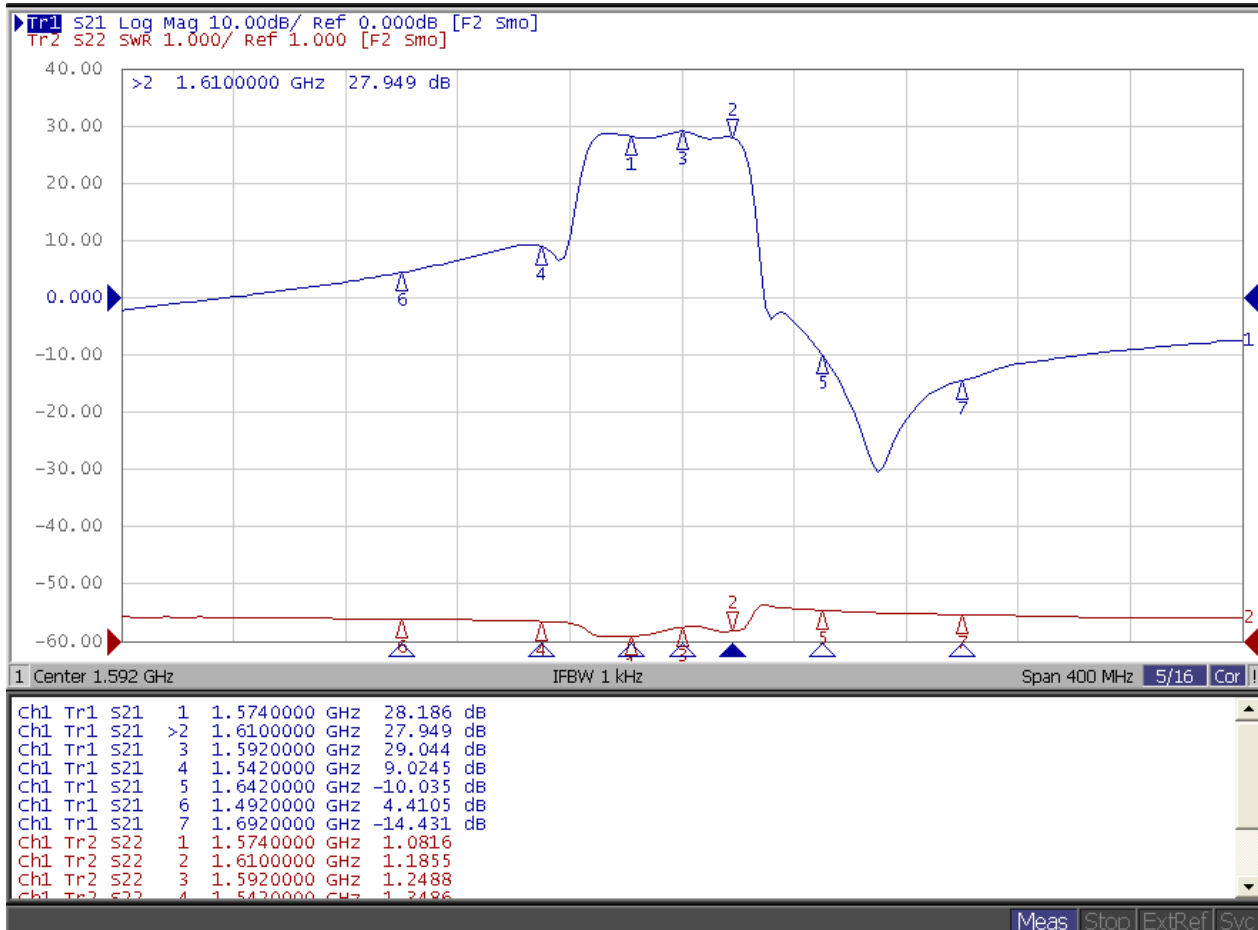
## 6.4.4 1602 MHz YZ-Plane





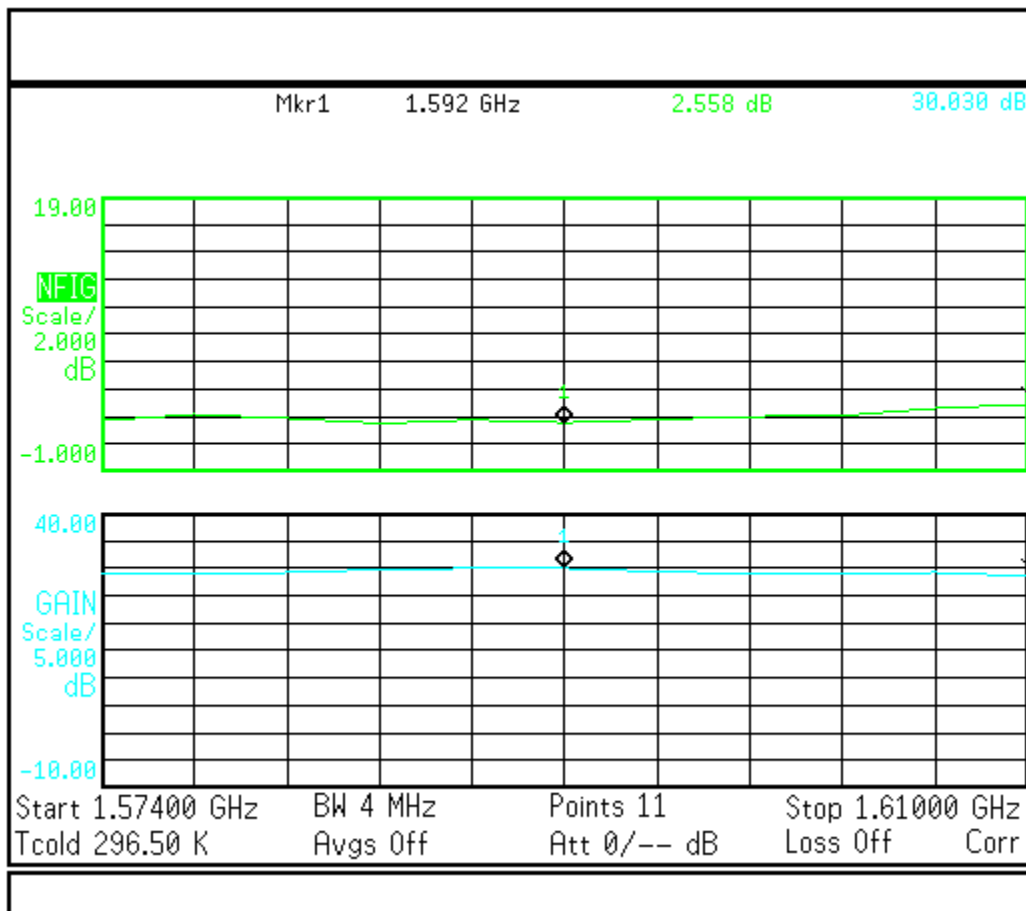
## 7. GPS/Galileo – Low Noise Amplifier

### 7.1 Gain and Out Band Rejection@3.0V





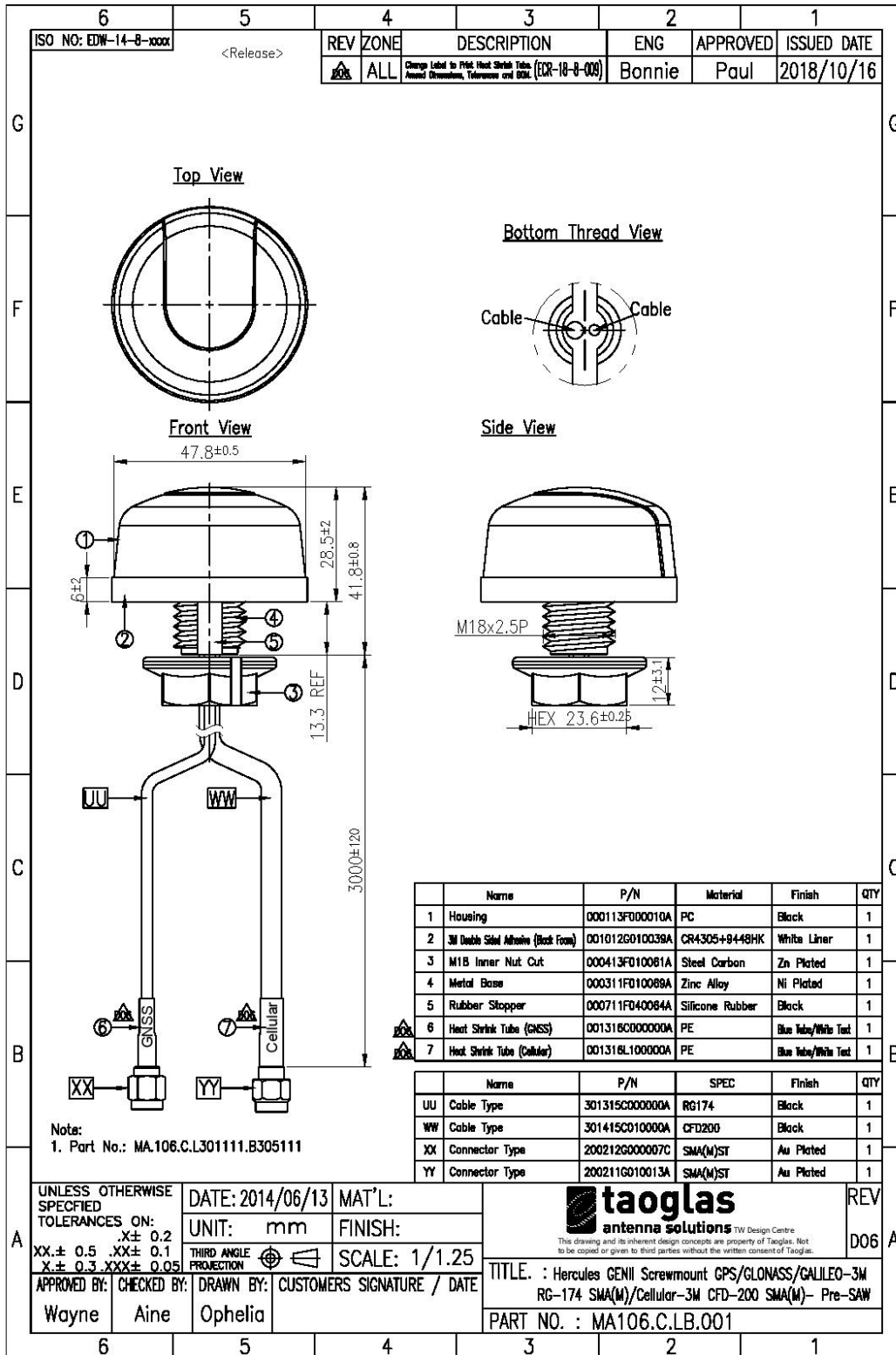
## 7.2 Noise Figure@3.0V



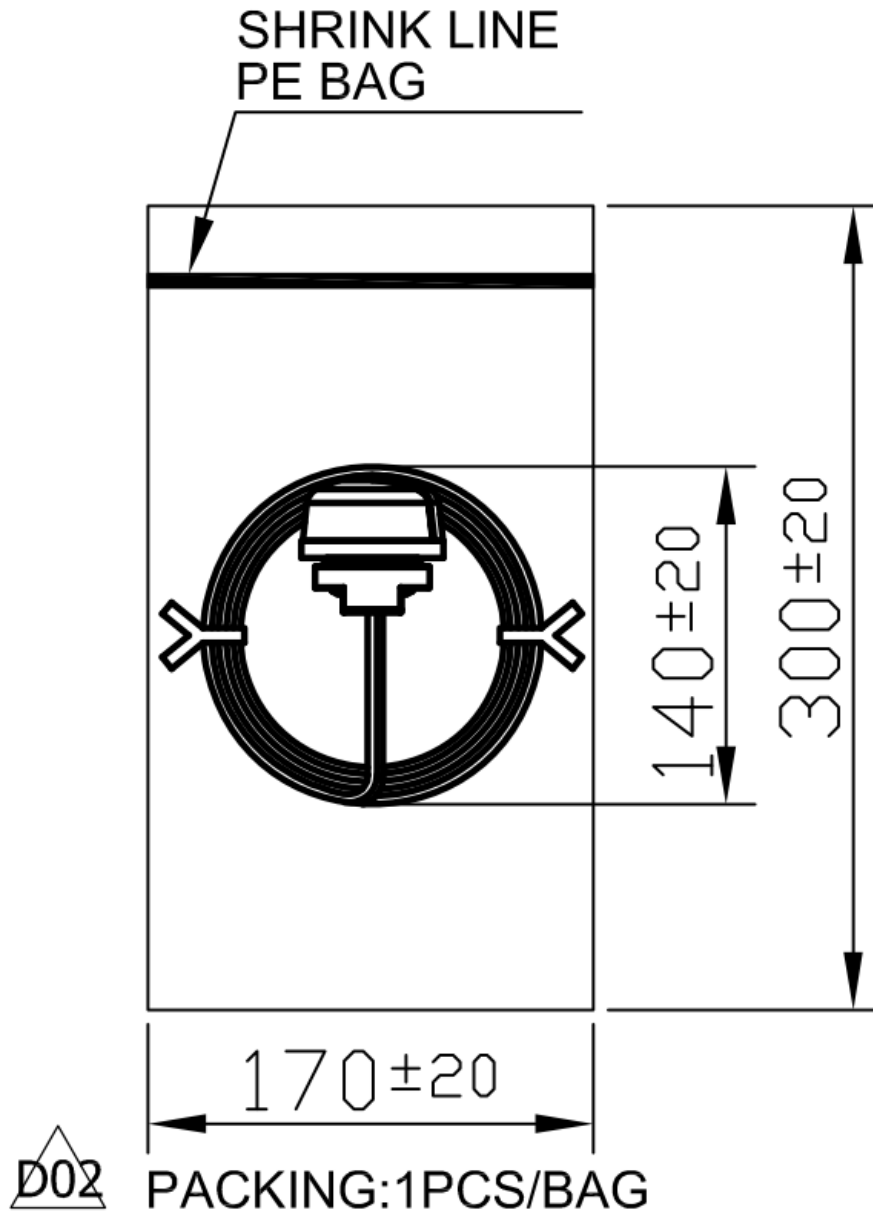


# TAOGLAS®

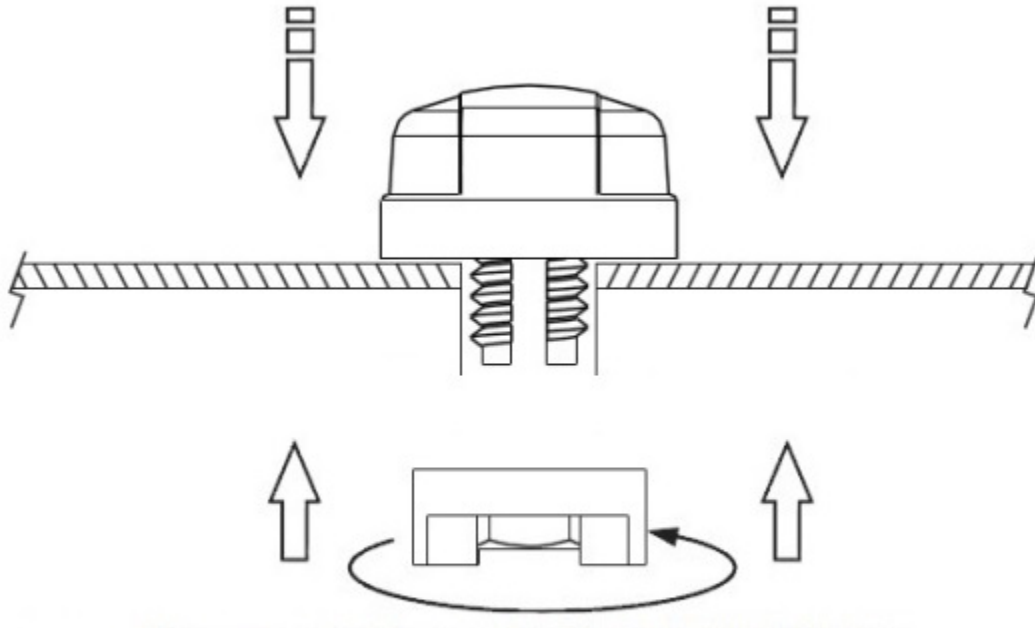
## 8. Drawing (Unit mm)



## 9.Packaging



## 10. Installation



Taoglas makes no warranties based on the accuracy or completeness of the contents of this document and reserves the right to make changes to specifications and product descriptions at any time without notice. Taoglas reserves all rights to this document and the information contained herein.

Reproduction, use or disclosure to third parties without express permission is strictly prohibited.

© Taoglas