

PFE1100-12-054xD

DC-DC Front-End Power Supply

The PFE1100-12-054xD is a 1100 watt DC to DC power supply that converts DC input into a main output of 12 VDC for powering intermediate bus architectures (IBA) in high performance and reliability servers, routers, and network switches.

The PFE1100-12-054xD meets international safety standards and displays the CE-Mark for the European Low Voltage Directive (LVD).

Key Features & Benefits

- Best-in-class, 80 PLUS certified “Platinum” efficiency
- Best-in-class, “Platinum level” efficiency
- Wide input voltage range: 40 – 72 VDC
- Always-On 16.5 W programmable standby output (3.3 / 5 V)
- Hot-plug capable
- Parallel operation with active digital current sharing
- High density design: 25.6 W/in³
- Small form factor: 321.5 x 54.5 x 40 mm (12.66 x 2.14 x 1.57 in)
- I²C communication interface for control, programming and monitoring with PSMI and Power Management Bus protocol
- Overtemperature, output overvoltage and overcurrent protection
- 256 Bytes of EEPROM for user information
- 2 Status LEDs: IN OK and OUT OK with fault signaling

Applications

- High Performance Servers
- Routers
- Switches



bel POWER
SOLUTIONS &
PROTECTION

a bel group

belfuse.com/power-solutions

1. ORDERING INFORMATION

PFE	1100	-	12	-	054	x	D
Product Family	Power Level	Dash	V1 Output	Dash	Width	Input	
PFE Front-Ends	1100 W		12 V		54 mm	N: Normal air flow R: Reverse air flow S: Screw type input connector / normal air flow T: Screw type input connector / reverse air flow	
						D: DC	

2. INPUT SPECIFICATIONS

General Condition: $T_A = 0... 45^\circ\text{C}$ unless otherwise specified.

PARAMETER	CONDITIONS / DESCRIPTION	MIN	NOM	MAX	UNIT
$V_{I\text{nom}}$	Nominal input voltage		53		VDC
V_I	Input voltage ranges	Normal operating ($V_{I\text{min}}$ to $V_{I\text{max}}$)		72	VDC
$I_{I\text{max}}$	Max input current			33	A_{rms}
I_p	Inrush Current Limitation	$V_{I\text{min}}$ to $V_{I\text{max}}$		60	A_p
$V_{I\text{on}}$	Turn-on input voltage ¹	Ramping up		45	VDC
$V_{I\text{off}}$	Turn-off input voltage ¹	Ramping down		40	VDC
η	Efficiency without fan	$V_{I\text{nom}}, 0.1 \cdot I_{I\text{nom}}, V_{X\text{nom}}, T_A = 25^\circ\text{C}$		89.3	
		$V_{I\text{nom}}, 0.2 \cdot I_{I\text{nom}}, V_{X\text{nom}}, T_A = 25^\circ\text{C}$		93.5	%
		$V_{I\text{nom}}, 0.5 \cdot I_{I\text{nom}}, V_{X\text{nom}}, T_A = 25^\circ\text{C}$		95	
		$V_{I\text{nom}}, I_{I\text{nom}}, V_{X\text{nom}}, T_A = 25^\circ\text{C}$		92.9	
T_{hold}	Hold-up Time	$V_I > 10.8\text{ V}, V_{\text{SB}}$ within regulation, $V_I = 53\text{ VDC}, P_{X\text{nom}}$		5	ms

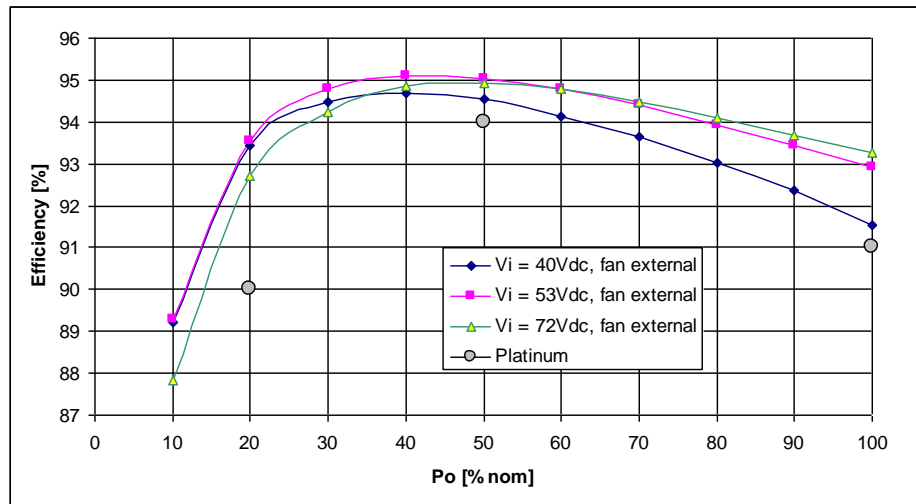

Figure 1. Efficiency

¹ The Front-End is provided with a minimum hysteresis of 3 V during turn-on and turn-off within the ranges.

3. OUTPUT SPECIFICATIONS

General Condition: $T_A = 0 \dots 45^\circ\text{C}$ unless otherwise specified.

PARAMETER	CONDITIONS / DESCRIPTION	MIN	NOM	MAX	UNIT
Main Output V_1					
$V_{1\text{ nom}}$	Nominal Output Voltage		12		VDC
$V_{1\text{ set}}$	Output Setpoint Accuracy	$0.5 \cdot I_{1\text{ nom}}, T_{\text{amb}} = 25^\circ\text{C}$		+0.5	% $V_{1\text{ nom}}$
$dV_{1\text{ tot}}$	Total Regulation	$V_{1\text{ min}}$ to $V_{1\text{ max}}, 0$ to 100% $I_{1\text{ nom}}, T_{\text{a min}}$ to $T_{\text{a max}}$		+1	% $V_{1\text{ nom}}$
$P_{1\text{ nom}}$	Nominal Output Power	$V_1 = 12\text{ VDC}$	1080		W
$I_{1\text{ nom}}$	Nominal Output Current	$V_1 = 12\text{ VDC}$	90		ADC
$V_{1\text{ pp}}$	Output Ripple Voltage	$V_{1\text{ nom}}, I_{1\text{ nom}}, 20\text{ MHz BW}, 10\text{nF}/16\text{V}/\text{X7R}/1210 + 10\mu\text{F}/16\text{V}$ at V_1		150	mVpp
$dV_{1\text{ Load}}$	Load Regulation	$V_1 = V_{1\text{ nom}}, 0 - 100\% I_{1\text{ nom}}$	80		mV
$dV_{1\text{ Line}}$	Line Regulation	$V_1 = V_{1\text{ min}} \dots V_{1\text{ max}}$	10		mV
$I_{1\text{ max}}$	Current Limitation		95	105	ADC
dI_{share}	Current Sharing	Deviation from $I_{1\text{ tot}} / N, I_1 > 10\%$	-3	+3	A
$dV_{1\text{ dyn}}$	Dynamic Load Regulation	$\Delta I_1 = 50\% I_{1\text{ nom}}, I_1 = 5 \dots 100\% I_{1\text{ nom}}, dI/dt = 1\text{ A}/\mu\text{s},$ recovery within 1% of $V_{1\text{ nom}}$	-0.6	0.6	V
T_{rec}	Recovery Time			1	ms
$t_{\text{AC } V_1}$	Start-Up Time From DC	$V_1 = 10.8\text{ VDC}$		2	sec
$t_{V_1\text{ rise}}$	Rise Time	$V_1 = 10 \dots 90\% V_{1\text{ nom}}$	1	10	ms
C_{Load}	Capacitive Loading	$T_a = 25^\circ\text{C}$		10 000	μF
Standby Output V_{SB}					
$V_{\text{SB nom}}$	Nominal Output Voltage	$0.5 \cdot I_{\text{SB nom}}, T_{\text{amb}} = 25^\circ\text{C}$	VSB_SEL = 1 3.3 VSB_SEL = 0 5		VDC VDC
$V_{\text{SB set}}$	Output Setpoint Accuracy		VSB_SEL = 0 / 1	+0.5	% $V_{1\text{ nom}}$
$dV_{\text{SB tot}}$	Total Regulation	$V_{1\text{ min}}$ to $V_{1\text{ max}}, 0$ to 100% $I_{\text{SB nom}}, T_{\text{a min}}$ to $T_{\text{a max}}$		+2	% $V_{\text{SB nom}}$
$P_{\text{SB nom}}$	Nominal Output Power	VSB_SEL = 0 / 1	16.5		W
$I_{\text{SB nom}}$	Nominal Output Current	$V_{\text{SB}} = 3.3\text{ VDC}$ $V_{\text{SB}} = 5.0\text{ VDC}$	5 3.3		ADC ADC
$V_{\text{SB pp}}$	Output Ripple Voltage	$V_{\text{SB nom}}, I_{\text{SB nom}}, 20\text{ MHz BW}, 10\text{nF}/16\text{V}/\text{X7R}/1210 + 10\mu\text{F}/16\text{V}$ at V_{SB}		100	mVpp
dV_{SB}	Droop	0 - 100% $I_{\text{SB nom}}$	VSB_SEL = 1 67 VSB_SEL = 0 44		mV mV
$I_{\text{SB max}}$	Current Limitation	VSB_SEL = 1 5.25 VSB_SEL = 0 3.45		6 4.3	ADC ADC
$dV_{\text{SB dyn}}$	Dynamic Load Regulation	$\Delta I_{\text{SB}} = 50\% I_{\text{SB nom}}, I_{\text{SB}} = 5 \dots 100\% I_{\text{SB nom}}, dI/dt = 0.5\text{ A}/\mu\text{s},$ recovery within 1% of $V_{1\text{ nom}}$	-3	3	% $V_{\text{SB nom}}$
T_{rec}	Recovery Time			250	μs
$t_{\text{AC } V_{\text{SB}}}$	Start-Up Time from DC Input	$V_{\text{SB}} = 90\% V_{\text{SB nom}}$		2	sec
$t_{V_{\text{SB}}\text{ rise}}$	Rise Time	$V_{\text{SB}} = 10 \dots 90\% V_{\text{SB nom}}$	4	10	ms
C_{Load}	Capacitive Loading	$T_{\text{amb}} = 25^\circ\text{C}$		10000	μF

4. SIGNAL & CONTROL SPECIFICATIONS

4.1 FRONT LEDs

OPERATING CONDITION	LED SIGNALING
IN LED (INPUT OK)	
DC Line within range	Solid Green
DC Line UV condition	Off
Redundant Operation - PSU1 operating and PSU2 has input power removed	Solid Yellow (PSU2) ¹
OUT LED² (OUTPUT OK)	
PSON High	Blinking Yellow (1:1)
Hot-Standby Mode	Blinking Yellow/Green (1:2)
V_I or V_{SB} out of regulation	
Over temperature shutdown	
Output over voltage shutdown (V_I or V_{SB})	Solid Yellow
Output over current shutdown (V_I or V_{SB})	
Fan error (>15%)	
Over temperature warning	Blinking Yellow/Green (2:1)
Minor fan regulation error (>5%, <15%)	Blinking Yellow/Green (1:1)
Redundant Operation - PSU1 operating and PSU2 has input power removed	Off (PSU2)

¹ The LEDs will be ON till input power from PSU1 is removed.

² The order of the criteria in the table corresponds to the testing precedence in the controller.

Table 1. LED Status

The front-end has 2 front LEDs showing the status of the supply. LED number one is green and indicates DC power is on or off, while LED number two is bi-colored: green and yellow and indicates DC power presence or fault situations. For the position of the LEDs see Figure 5.

4.2 GRAPHICAL USER INTERFACE

The Bel Power Solutions provides with its “I²C Utility” a Windows® XP/Vista/Win7 compatible graphical user interface allowing the programming and monitoring of the PFE1100-12-054xD Front-End.

The utility can be downloaded on www.belpowersolutions.com and supports both the PSM1 and Power Management Bus protocols.

The GUI allows automatic discovery of the units connected to the communication bus and will show them in the navigation tree. In the monitoring view the power supply can be controlled and monitored.

If the GUI is used in conjunction with the PFE1100-12-054xD Evaluation Kit it is also possible to control the PSON pin(s) of the power supply.

Further there is a button to disable the internal fan for approximately 5 seconds (not implemented yet). This allows the user to take input power measurements without fan consumptions to check efficiency compliance to the Climate Saver Computing Platinum specification.

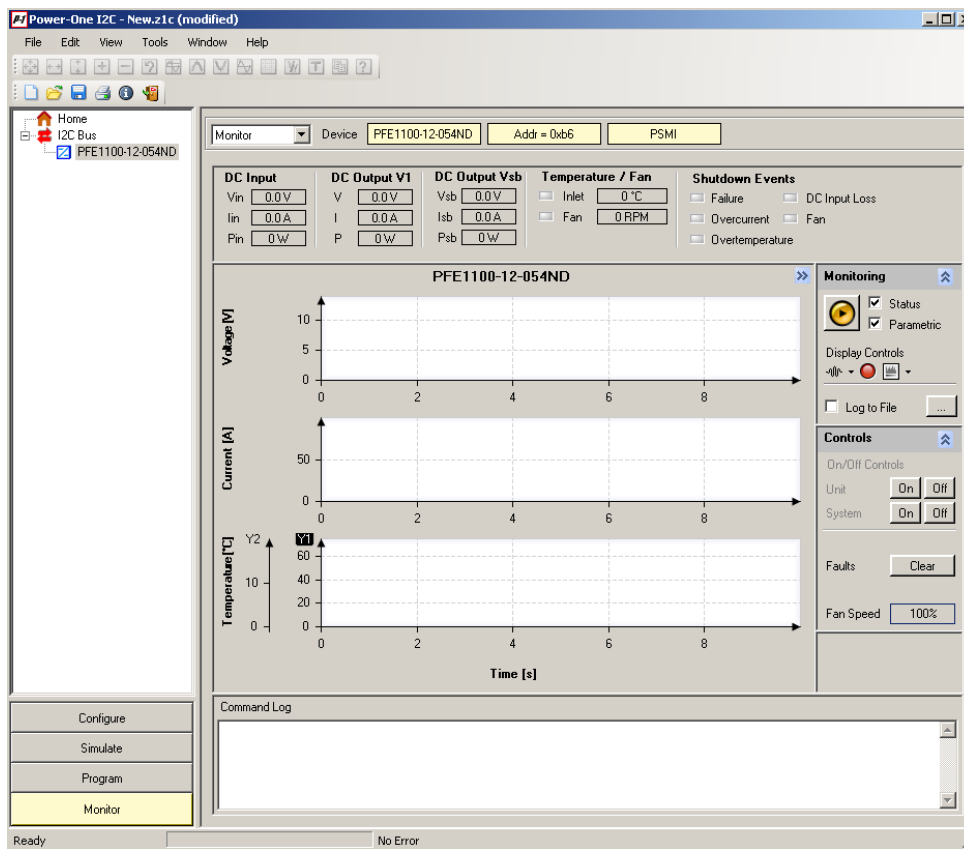

Figure 2. I2C Bus to uC (Graphical User Interface)

The monitoring screen also allows to enable the hot-standby mode on the power supply. The mode status is monitored and by changing the load current it can be monitored when the power supply is being disabled for further energy savings. This obviously requires 2 power supplies being operated as a redundant system (like the evaluation kit).

NOTE: The user of the GUI needs to ensure that only one of the power supplies have the hot-standby mode enabled.



Asia-Pacific
+86 755 298 85888

Europe, Middle East
+353 61 225 977

North America
+1 408 785 5200

5. ELECTROMAGNETIC COMPATIBILITY

NOTE: Meets the EMC requirements according to EN IEC 61204-3, EN 55035 and EN 55032.

5.1 IMMUNITY

TEST	STANDARD / DESCRIPTION	CRITERIA
ESD Contact Discharge	IEC / EN 61000-4-2, ± 8 kV, 25 + 25 discharges per test point (metallic case, LEDs, connector body)	B
ESD Air Discharge	IEC / EN 61000-4-2, ± 15 kV, 25 + 25 discharges per test point (non-metallic user accessible surfaces)	B
Radiated Electromagnetic Field	IEC / EN 61000-4-3, 10 V/m, 1 kHz / 80% Amplitude Modulation, 1 μ s Pulse Modulation, 10 kHz...2 GHz	A
Burst	IEC / EN 61000-4-4, Level 3 Input DC port ± 1 kV, 1 minute DC port ± 0.5 kV, 1 minute	B
Surge	IEC / EN 61000-4-5 Line to earth: ± 1 kV Line to line: ± 0.5 kV	A
RF Conducted Immunity	IEC/EN 61000-4-6, Level 3, 10 Vrms, CW, 0.1 ... 80 MHz	A

5.2 EMISSION

TEST	STANDARD / DESCRIPTION	CRITERIA
Conducted Emission	EN55032 / CISPR 32: 0.15 ... 30 MHz, QP and AVG, single unit, $V_f = 53$ VDC, $P_{x, nom}$	Class A 6 dB margin
	EN55032 / CISPR 32: 0.15 ... 30 MHz, QP and AVG, 2 units in rack system, $V_f = 53$ VDC, $P_{x, nom}$	Class A 6 dB margin
Radiated Emission	EN55032 / CISPR 32: 30 MHz ... 1 GHz, QP, single unit, $V_f = 53$ VDC, $P_{x, nom}$	Class A 6 dB margin
	EN55032 / CISPR 32: 30 MHz ... 1 GHz, QP, 2 units in rack system, $V_f = 53$ VDC, $P_{x, nom}$	Class A 6 dB margin
Acoustical Noise	Sound power statistical declaration (ISO 9296, ISO 7779, IS9295) @ 50% load	62 dBA

6. SAFETY / APPROVALS

Maximum electric strength testing is performed in the factory according to EN/IEC 62368-1, and UL 62368-1. Input-to-output electric strength tests should not be repeated in the field. Bel Power Solutions will not honor any warranty claims resulting from electric strength field tests.

PARAMETER	DESCRIPTION / CONDITION	MIN	NOM	MAX	UNIT
Agency Approvals	Approved to latest edition of the following standards: UL/CSA 62368-1, EN/IEC 62368-1				
Isolation Strength	Input (L/N) to case (PE)		Basic		
	Input (L/N) to output		Basic		
	Output to case (PE)		Functional		
α Creepage / Clearance	Primary (L/N) to protective earth (PE)				
	Primary to secondary				
Electrical Strength Test	Input to case	1500			VDC
	Input to output (tested by manufacturer only)	1500			

7. ENVIRONMENTAL SPECIFICATIONS

PARAMETER	DESCRIPTION / CONDITION	MIN	NOM	MAX	UNIT	
T_A	Ambient Temperature	$V_{i\min}$ to $V_{i\max}$, $I_{n\text{ nom}}$, $I_{SB\text{ nom}}$		0	+45	°C
T_{Aext}	Extended Temp. Range	Derated output		+45	+65	°C
		$V_{i\min}$ to $V_{i\max}$ / $I < 77\text{ A}$, $I_{SB\text{ nom}}$			+55	°C
		$V_{i\min}$ to $V_{i\max}$ / $I < 35\text{ A}$, $I_{SB\text{ nom}}$			+65	°C
T_S	Storage Temperature	Non-operational		-20	+70	°C
N_a	Audible Noise	Sound power @ $V_{i\text{ nom}}$, 50% $I_{n\text{ nom}}$, $T_A = 25^\circ\text{C}$		62		dBA

8. MECHANICAL SPECIFICATIONS

PARAMETER	DESCRIPTION / CONDITION	MIN	NOM	MAX	UNIT
Dimensions	Width		54.5		mm
	Height		40		
	Depth		321.5		
M	Weight		1.12		kg

NOTE: Tolerance (unless otherwise stated): 0 - 30 mm: +/- 0.2 mm; 30 - 120 mm: +/- 0.4 mm; 120 - 400 mm: +/-0.6 mm

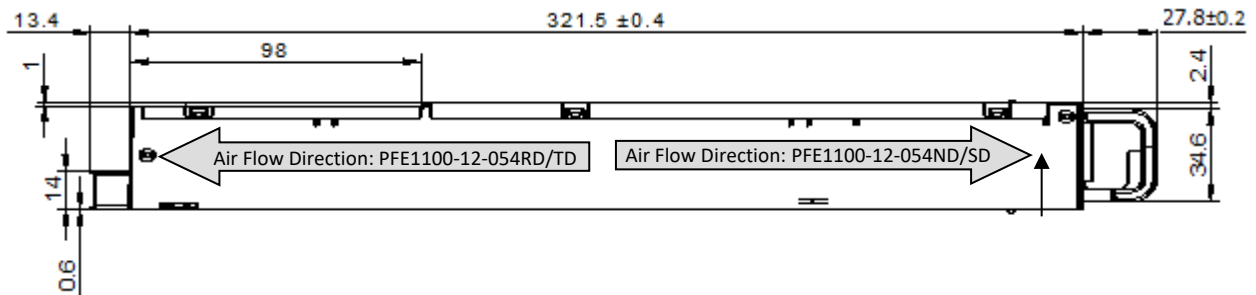

NOTES: A 3D step file of the power supply casing is available on request.
 Unlatching the supply is performed by pulling the green trigger in the handle.

Figure 3. Side View 1

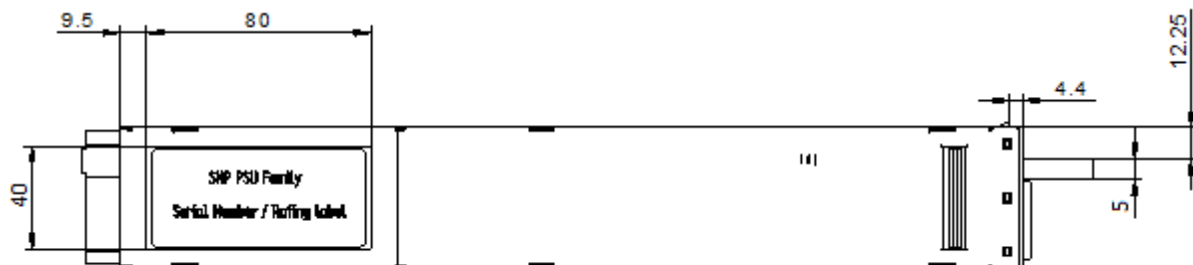

Figure 4. Top View

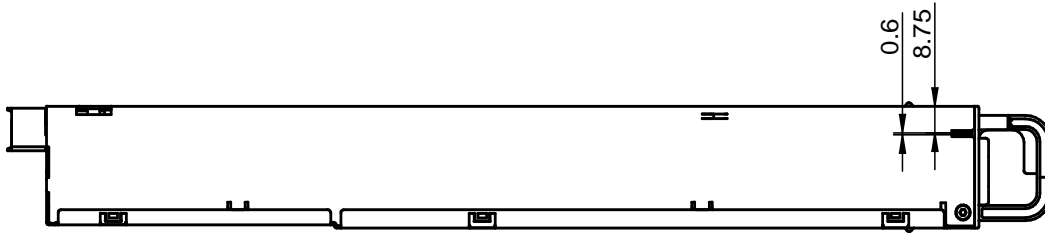

Figure 5. Side View 2

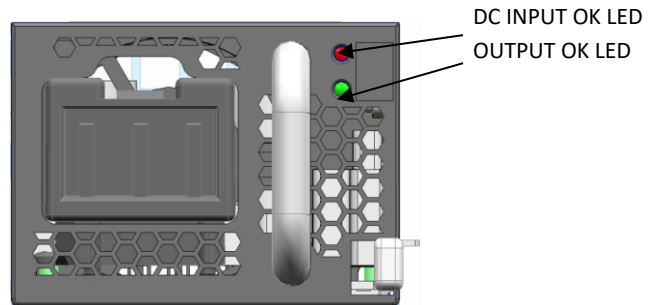
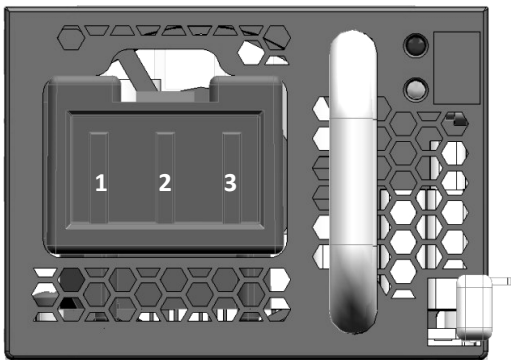

Figure 6. Front View (PFE1100-12-054ND/RD)

9. CONNECTIONS

9.1 INPUT CONNECTOR



PIN	NAME	DESCRIPTION
<i>Input</i>		
1	Vin+	Input positive
2	Vin-	Input negative
3	PE	Ground

Unit: China Aviation (JOHNON OPTRONIC) P/N DP5ZJW0300-001
 Counter part: China Aviation (JOHNON OPTRONIC) P/N DP5TJY0300-001(provided)

9.2 OUTPUT CONNECTOR

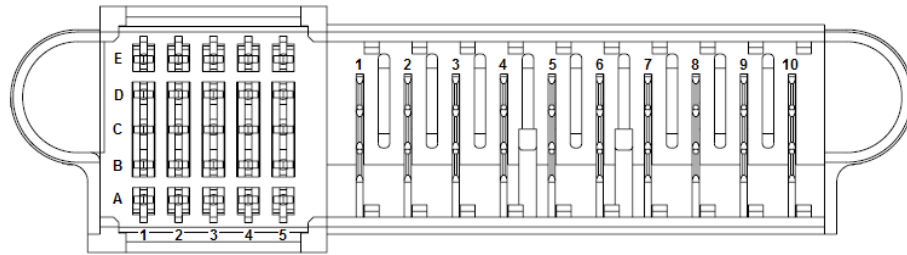

Unit: Tyco Electronics P/N: 1926736-3
FCI P/N: 101-22460-007LF

Counter part: Tyco Electronics P/N: 2-1926739-5
FCI P/N: 10108888-R10253SLF

NOTE: Column 5 is lagging (short pins)

PIN	NAME	DESCRIPTION
<i>Output</i>		
6, 7, 8, 9, 10	V1	+12 VDC main output
1, 2, 3, 4, 5	PGND	Power ground (return)
<i>Control Pins</i>		
A1	VSB	Standby positive output (+3.3 / 5 V)
B1	VSB	Standby positive output (+3.3 / 5 V)
C1	VSB	Standby positive output (+3.3 / 5 V)
D1	VSB	Standby positive output (+3.3 / 5 V)
E1	VSB	Standby positive output (+3.3 / 5 V)
A2	SGND	Signal ground (return)
B2	SGND	Signal ground (return)
C2	HOTSTANDBYEN	Hot standby enable signal
D2	VSB_SENSE_R	Standby output negative sense
E2	VSB_SENSE	Standby output positive sense
A3	APS	I ² C address and protocol selection (select by a pull down resistor)
B3	nc	Reserved
C3	SDA	I ² C data signal line
D3	V1_SENSE_R	Main output negative sense
E3	V1_SENSE	Main output positive sense
A4	SCL	I ² C clock signal line
B4	PSON	Power supply on input (connect to A2/B2 to turn unit on)
C4	SMB_ALERT	SMB Alert signal output
D4	nc	Reserved
E4	INOK	DC input OK signal
A5	PSKILL	Power supply kill (lagging pin)
B5	ISHARE	Current share bus (lagging pin)
C5	PWOK	Power OK signal output (lagging pin)
D5	VSB_SEL	Standby voltage selection (lagging pin)
E5	PRESENT_L	Power supply present (lagging pin)

Table 2. Pin Description

9.3 INPUT CONNECTOR MODIFICATION - MODELS PFE1100-12-054SD/TD

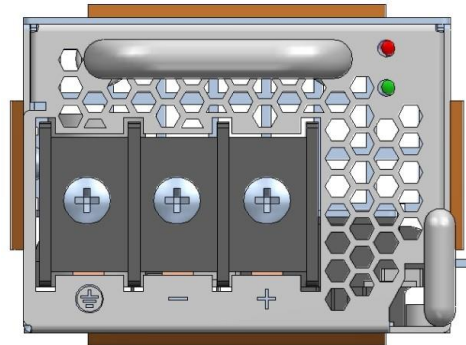

Figure 7. Front View (PFE1100-12-054SD/TD)

Unit: MF: Dinkle; P/N: DT-66-B11W-03
 Counter part: Wire with lugs: 18 – 8 AWG (wire range); lugs for M4 screws

NOTE: Column 5 is lagging (short pins)

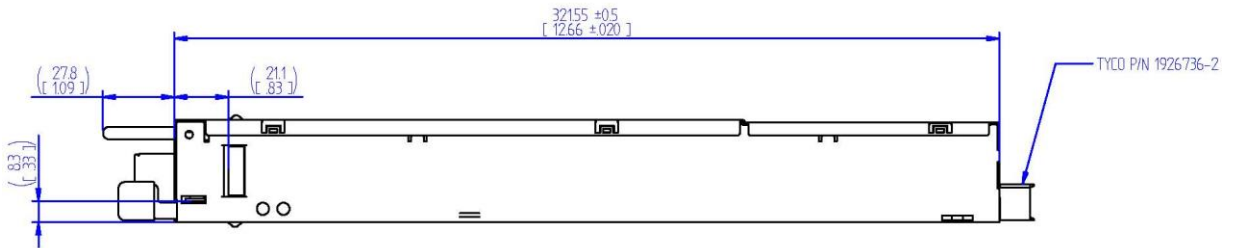

Figure 8. Side View (PFE1100-12-054SD/TD)

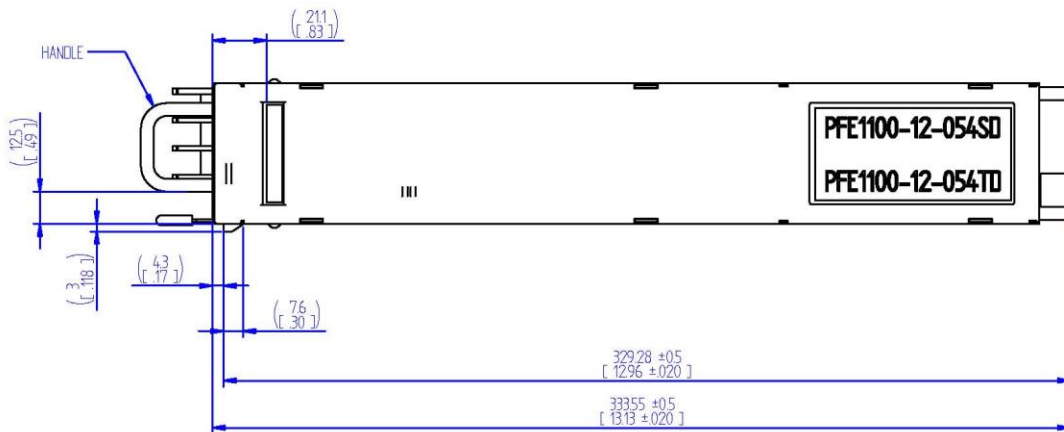

Figure 9. Top View (PFE1100-12-054SD/TD)

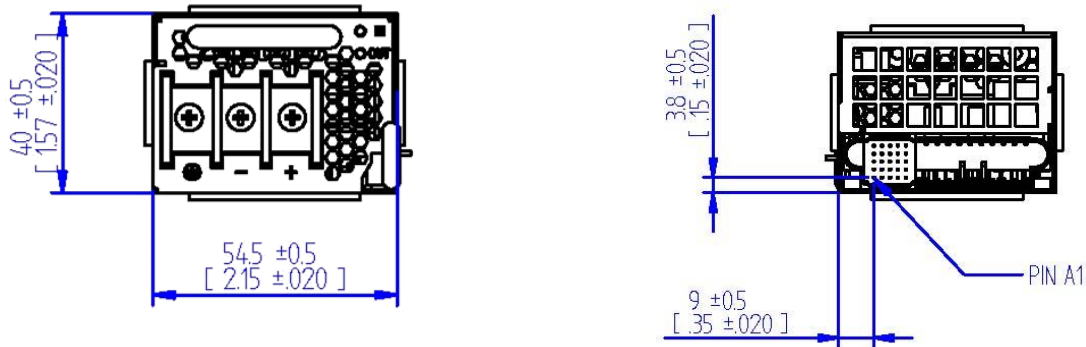

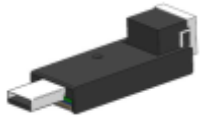

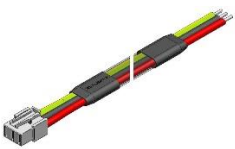
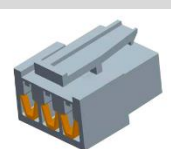

Figure 10. Front and Rear View (PFE1100-12-054SD/TD)

10. ACCESSORIES

ITEM	DESCRIPTION	ORDERING PART NUMBER	SOURCE
	I²C Utility Windows XP/Vista/7 compatible GUI to program, control and monitor PFE Front-Ends (and other I²C units)	N/A	belfuse.com/power-solutions
	USB to I²C Converter Master I²C device to program, control and monitor I²C units in conjunction with the <i>I²C Utility</i>	ZM-00056	Bel Power Solutions
	Dual Connector Board Connector board to operate 2 PFE units in parallel. Includes an on-board USB to I²C converter (use <i>I²C Utility</i> as desktop software)	SNP-OP-BOARD-01	Bel Power Solutions
	Cable Harness with Mating input Connector CHINA AVIATION , PN: DP5TJY0300-001 , 2.44m length, 10AWG wire with 10mm stripping at the end, encased with braided sleeving	ZLH.00742	Bel Power Solutions
	Female Pin Connector Terminal Spare Mating Connectors	ZES.00046	Bel Power Solutions

11. APPENDIX

11.1 SOCKET CRIMPING OPERATION INSTRUCTION (DP5TJY0300-001)

I. CRIMPING TOOLS AND MACHINE PREPARATION

Machine needed before crimping: Terminal Crimping Machine, Crimping Mould, Crimping Tools, Wire Strippers, Utility Knife and Wrench.

NOTES: 1. Crimping tool need to install onto crimping mould, and crimping mould need to fix onto crimping machine.
2. Two factors must be considered during the design of crimping mould:
A: must meet dimensions of tools installation.
B: Easy to install in machine and be in machine effective itinerary

NAME	SUPPLIER	PART NUMBER
Terminal Crimping Machine	JonHon Optronic	THB Terminal Crimping Machine
Crimping Mould	JonHon Optronic	12A-01
Crimping tools	JonHon Optronic	YJD-DP5

Crimping tools YJD-DP5 including 4 parts: 4U-A5881-1, 4U-A5881-2, 4D-A5881-1, 4D-A5881-2. (See picture 1)

Table 1. A Set of Machine Recommended

II. CRIMPING MACHINE AND TOOLS INSTALLATION

Crimping mould and crimping tools must be installed well before crimping.

Install Requirements:

1. Up tools 4U-A5881-1 and 4U-A5881-2 need install in dynamic mould. Down Tools 4D-A5881-1 and 4D-A5881-2 need install in static mould. (See picture 2)
2. 4 pieces of crimping tools can be divided into 2 pairs: 4U-A5881-1 mated with 4D-A5881-1, which is crimping cable jacket. 4U-A5881-2 match 4D-A5881-2, which is crimping cable core.
3. Up tool 4U-A5881-1 has U-shaped hole. Customer can adjust the install position according to wire thickness, which to make sure the wire jacket and core will be crimping tightly. Tool 4D-A5881-1 need to install outside of crimping mould, in order to adjust tool 4U-A5881-1. (Reference at Picture 2)



Picture 1. YJD-DP5 (4 pieces crimping tools)

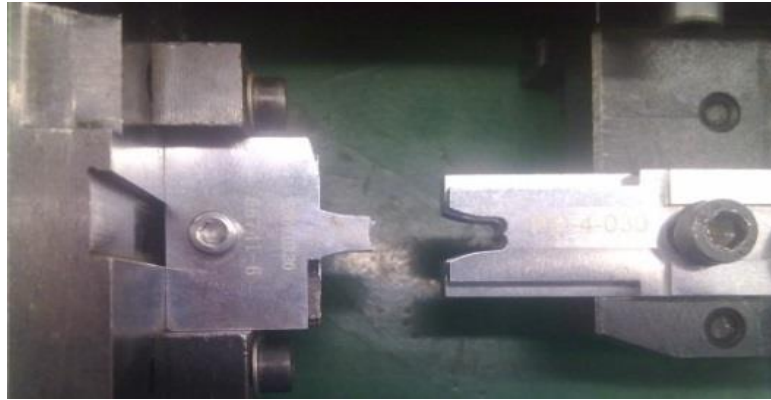

Picture 2. Tools Installation

III. CRIMPING

1. **Wire Cutting:** Cutting wire with required length, and the wire can be used 8AWG American standard wire or other 8mm² wire.
2. **Wire Stripping:** Stripping the wire jacket 8±1mm with Wire Strippers and cutting the jacket straight with Utility Knife. The wire should be at the set of bundles after stripping, shown as Picture 3.



Picture 3. The wire stripped



Picture 4. Wire and Terminal before Crimping

3. **Crimping:** Placing the wire and the terminal shown as picture 4, and placing them into the gap between up tool and down tool shown as picture 5.



Picture 5. Position before Crimping

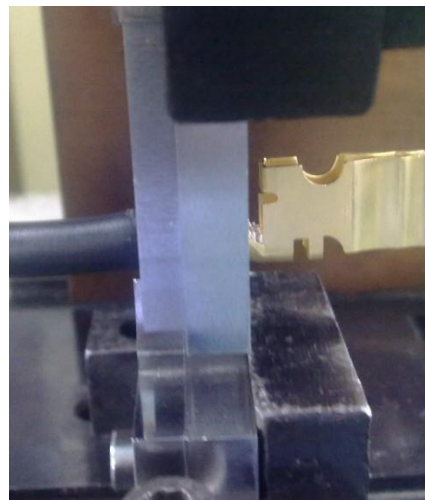

Picture 6. Position after crimped

4. Start the terminal crimping machine, and crimping closed shown as picture 6.
5. **Test after Crimping**
 - a) **Appearance Inspection:** The crimped position should be smooth and firm. (reference see picture 7)



Picture 7.

If the severe deformation after crimping, we need to adjust the machine knob to adjust the crimping mould and distance between up tool and down tool, which to ensure the crimp the wire correctly and beautifully. Meanwhile, we need to avoid too much crimping strength so as to short the tools life, or even to damage the tools.

- b) **Pulling-Out Force Test:** When the first batch after a terminal crimping, crimp pull out force should be inspected

Test Method: Fixed the terminal and Non-crimped wire onto ends of tension meter, and then gradually increase the tension until the wire is pulled and separated from the terminal, and read the tension meter reading is to pull off the greatest force.

Qualification Criterion: When the pull-out force meets the requirements of Table 2, and then can show pull-out force is qualified.

Failure Treatment: When the pull-out force failed, we need to adjust the machine knob to adjust the crimping mould and distance between up tool and down tool, and then re-crimp until the test qualified. After that, we can make mass production.

CABLE SIZE	CORE CROSS-SECTIONAL AREA	PULL-OUT FORCE
8 AWG	8.5 mm ²	950 N
10 AWG	5.5 mm ²	650 N

Table 2. Pull-Out Force Table

NOTE: Mid-value clustering Method will be used if core cross-sectional area is not in the range of Table 2

IV. TREATMENT AFTER CRIMPING

Crimping tools, crimping mould should be removed from crimping machine and properly kept after crimping work.

11.2 INPUT CONNECTOR DATASHEET (DP5ZJW0300-001/DP5TJY0300-001)

- **Material Code :**
- **Part Name :** DP5ZJW0300-001 3pin PCB receptacle, DP5TJY0300-001 3 pin crimp plug
- **Part Number :** Receptacle (fix connector) DP5ZJW0300-001
Plug (moving connector) DP5TJY0300-001
- **Information of environment protection: compliant with ROHS**
- **Technical Parameter Mated :**
 - **Electrical**
 - Current rating: 40 A at 55°C (accord with UL1977)
 - Withstanding voltage: 1500 V
 - Insulation Resistance \geq 500 M Ω (Normal temperature); \geq 100 M Ω (Damp Heat)
 - Hot plug function: Can meet the over load requirement of UL1977
 - **Mechanical Characteristics**
 - Terminal type: receptacle PCB, plug crimp
 - Service life: 250 cycles
 - **Material and Surface Treatment**
 - Contact material sockets: Copper alloy; pins: Copper
Surface Treatment : 0.2~0.6 μ m gold plated over 1.27 μ m nickel (or 5 μ m silver, up to customer requirement)
 - Housing material & processing
Material: glass fiber strengthened flameless PET UL94V-0
Color: black
Processing method: plastic injection
 - **Operating Environment**
 - Range of temperature : -55°C~125°C
 - Humidity: 93% at 40°C
 - Shock acceleration 490 m/s²
 - Vibration: 10Hz~2000 Hz, acceleration: 98 m/s²
 - **Dimensions of Product**
 - Dimension

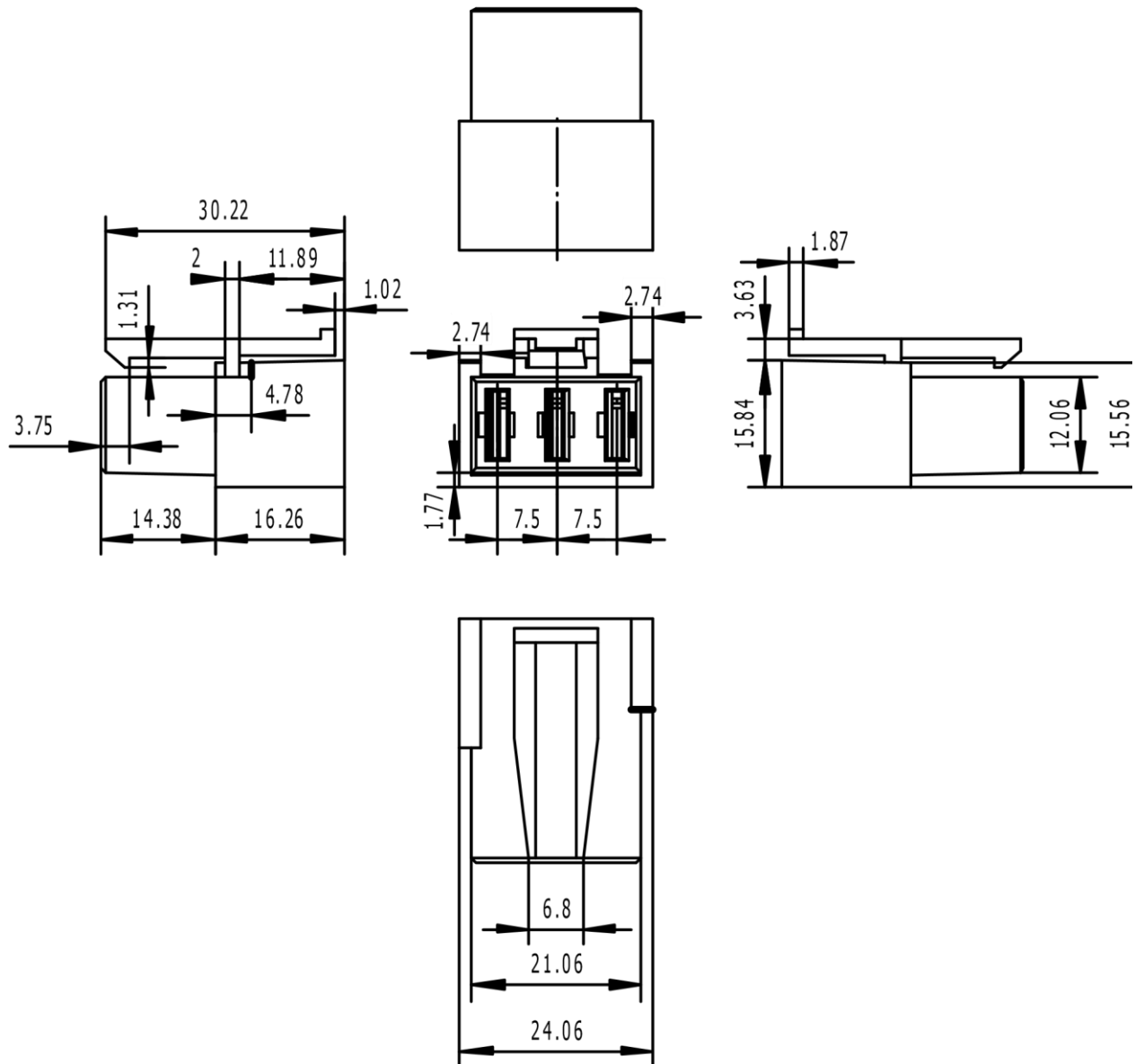

Picture 8. Receptacle: DP5ZJW0300-001

For more information on these products consult: tech.support@psbel.com

NUCLEAR AND MEDICAL APPLICATIONS - Products are not designed or intended for use as critical components in life support systems, equipment used in hazardous environments, or nuclear control systems.

TECHNICAL REVISIONS - The appearance of products, including safety agency certifications pictured on labels, may change depending on the date manufactured. Specifications are subject to change without notice.