

Type 2JQ / 3JQ Quick-Acting Fuse Series

HF  2JQ/3JQ Series, 5x15mm Glass Tube Quick-Acting Fuse

RoHS Compliant

Description

5x15mm Quick-Acting, glass tube body cartridge fuse designed, approved and complied with UL and CSA standard 248-14.

Features

- Meet UL and CSA standard 248-14
- Wide operating temperature range
- Bulk and Tape & Reel packing available
- Full compliance with EU Directive 2011/65/EU and amending directive 2015/863
- Halogen Free
- Lead Free

Applications

Provide individual protection for components or internal circuits.



- Power supplies
- Battery charger
- Monitor
- Adapter

LEAD FREE = 

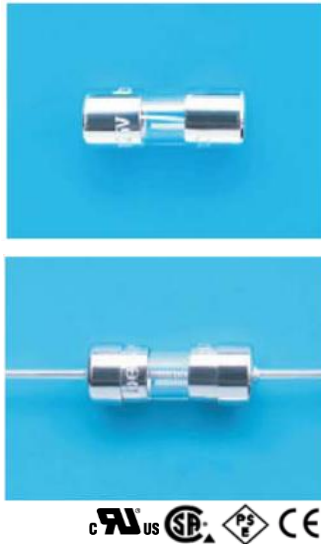
HALOGEN FREE = 





Physical Specifications

Materials	Body : Glass
	Cap : Nickel Plated Brass Caps
	Leads : Matte Tin Plated Copper
Marking	On Fuse :
	"bel", "JQ", "Current Rating", "Voltage Rating", "Appropriate Safety Logos", "✓" (RoHS compliant)
	On Label :
	"bel", "2JQ"or"3JQ", "Current Rating", "Voltage Rating", "Interrupting Rating", "Appropriate Safety Logos" and "  ", "  "(China RoHS compliant).

Electrical Characteristics (UL/CSA STD.248-14)

Testing Current	Blow Time	
	Minimum	Maximum
100%	4 hrs.	N/A
135%	N/A	1 hr.
200%	N/A	1 sec



Safety Agency Approvals

Safety Agency	Safety Agency Certificate	Ampere Rating/ Voltage Rating	Ampere Range / Volt @ I.R. ability*
	E20624	500mA-7A /350V AC	500mA-7A / 350V AC@100A 140V DC@150A
	LR39772		500mA-7A / 350V AC @100A
	JET1037-31003-1010 JET1037-31003-1011		1A-5A / 125V AC@500A
	JET1037-31003-1007		>5A-15A / 125V AC@300A
*I.R.= Interrupting Rating = Short Circuit Rating(Amps)			

Environmental Specifications

Shock Resistance	MIL-STD-202G, Method 213B, Test Condition 1 (100 G's peak for 6 milliseconds; Sawtooth waveform)
Vibration Resistance	MIL-STD-202G, Method 201A (10-55 Hz, 0.06 inch, total excursion).
Salt Spray Resistance	MIL-STD-202G, Method 101E, Test Condition B (48 hrs).
Insulation Resistance	MIL-STD-202G, Method 302, Test Condition A (After Opening) 10,000 ohms minimum.
Solderability	MIL-STD-202G, Method 208H
Resistance to solder Heat	MIL-STD-202G, Method 210F, Test Condition B (260+/-5°C, 10+/-1 sec)
Thermal Shock	MIL-STD-202G, Method 107G, Test Condition B (-65°C to +125°C).
Operating Temperature	-55°C to +125°C
Terminal Strength	IEC-68-2-21

Electrical Specifications

Catalog Number	Ampere Rating	Typical Cold Resistance (ohms)	Volt-drop @100%In (Volt) max.	Voltage and Interrupting Ratings	Melting I²T <10 m Sec (A² Sec)	Melting I²T @10 In (A² Sec)	Maximum Power Dissipation (W)	Agency Approvals		
										
JQ 500-R	500mA	0.33	0.55	See Table of Safety Approvals on Page 1 for Voltage and associated Interrupting Ratings	0.10	0.11	0.092	Y	Y	
JQ 600-R	600mA	0.26	0.48		0.14	0.16	0.10	Y	Y	
JQ 750-R	750mA	0.188	0.45		0.26	0.30	0.12	Y	Y	
JQ 800-R	800mA	0.170	0.40		0.27	0.40	0.17	Y	Y	
JQ 1-R	1A	0.112	0.40		0.62	0.65	0.21	Y	Y	Y
JQ 1.25-R	1.25A	0.068	0.17		0.80	0.82	0.26	Y	Y	Y
JQ 1.5-R	1.5A	0.056	0.16		1.4	1.4	0.32	Y	Y	Y
JQ 1.6-R	1.6A	0.054	0.16		1.8	1.9	0.35	Y	Y	Y
JQ 2-R	2A	0.041	0.16		2.3	2.5	0.39	Y	Y	Y
JQ 2.5-R	2.5A	0.033	0.15		4.0	4.3	0.48	Y	Y	Y
JQ 3-R	3A	0.027	0.15		4.6	5.6	0.59	Y	Y	Y
JQ 3.5-R	3.5A	0.022	0.14		9	10	0.66	Y	Y	Y
JQ 4-R	4A	0.019	0.14		12	13	0.73	Y	Y	Y
JQ 5-R	5A	0.015	0.13		20	23	0.9	Y	Y	Y
JQ 6-R	6A	0.012	0.13		35	40	1.1	Y	Y	Y
JQ 7-R	7A	0.010	0.12		46	53	1.2	Y	Y	Y

Consult manufacturer for other ratings



Specifications subject to change without notice

Bel Fuse Inc.
206 Van Vorst Street
Jersey City, NJ 07302 USA

+1 201.432.0463
Bel.US.CS@belf.com
belfuse.com/circuit-protection

Temperature Derating Curve

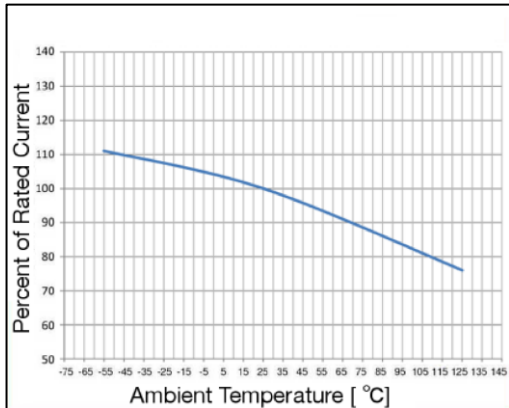

Average Time Current Curve

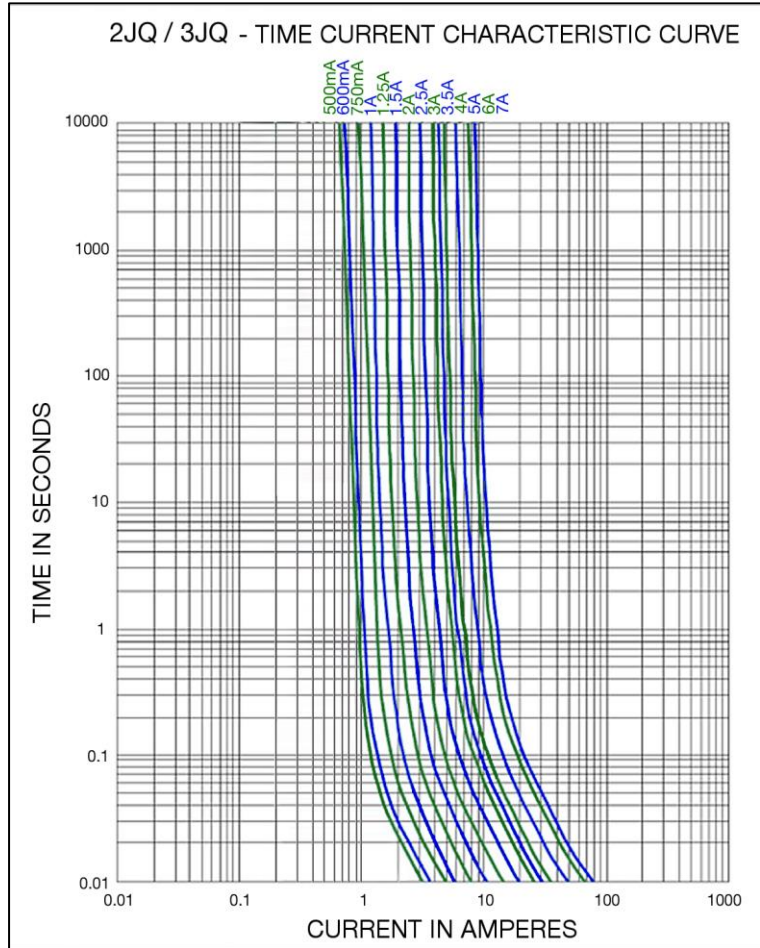

Soldering Parameters

Lead-free Wave Soldering Profile	
Wave Soldering Parameter	
Average ramp-up rate	200°C / second
Heating rate during preheat	typical 1 - 2°C / second Max 4°C / second
Final preheat temperature	within 125°C of soldering temperature
Peak temperature T _p	260°C
Time within +0°C / -5°C of actual peak temperature	10 seconds
Ramp-down rate	5°C / second max.

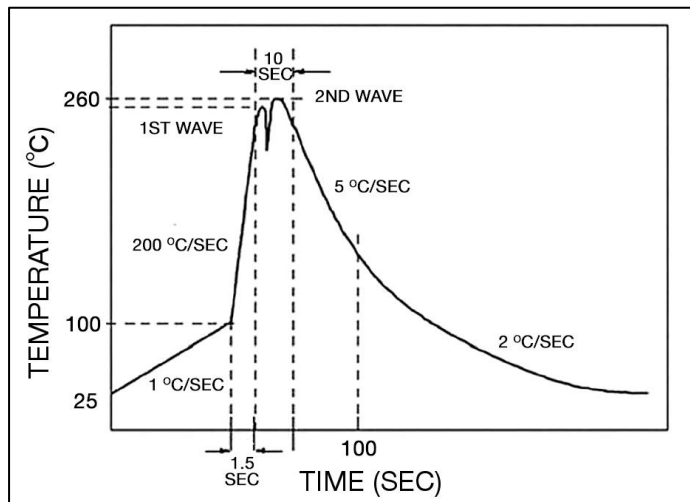

Fuse FGNO Explanation

0657 R [XXXX] -XX

0657R=2JQ/3JQ; [XXXX]=Ampere Rating; XX=See Ordering Information as below

Fraction	Decimal	Milliamps	Bel FGNO[XXXX]
1/2	.500	500	0500
6/10	.600	600	0600
3/4	.750	750	0750
8/10	.800	800	0800

Fraction	Decimal	Amps	Bel FGNO[XXXX]
	1.0	1	1000
1-1/4	1.25	1.25	1250
1-1/2	1.50	1.5	1500
	1.60	1.6	1600
	2.0	2	2000
2-1/2	2.5	2.5	2500
	3.0	3	3000
3-1/2	3.5	3.5	3500
	4.0	4	4000
	5.0	5	5000
	6.0	6	6000
	7.0	7	7000

Mechanical Dimensions

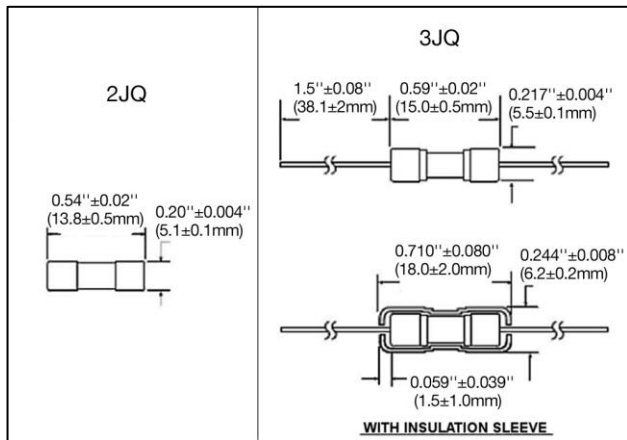

*Diameter lead 0.032" ± 0.002" for all ratings

Ordering Information

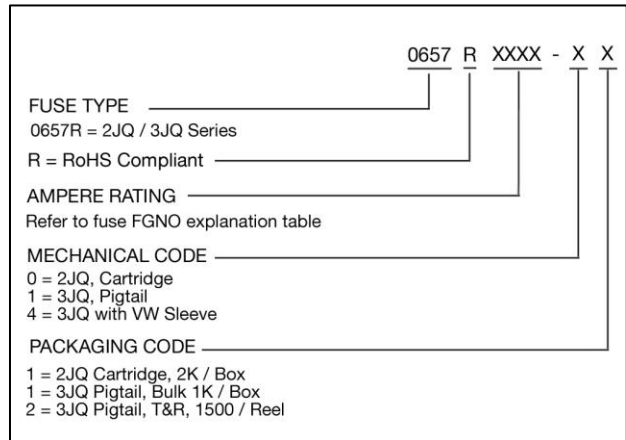

Packaging

Packaging Option	Packaging Specification	Quantity	Packaging Code	Inside Tape Spacing
Bulk (bag)	N/A	2000	01	N/A
Bulk (Pigtail Type)	N/A	1000	11	N/A
Bulk (Pigtail Type) with Insulation Sleeve	N/A	1000	41	N/A
Tape & Reel	EIA-296-F	1500	12	10mm Pitch and 53mm
Tape & Reel with Insulation Sleeve	EIA-296-F	1500	42	10mm Pitch and 53mm



Specifications subject to change without notice

Bel Fuse Inc.
206 Van Vorst Street
Jersey City, NJ 07302 USA

+1 201.432.0463
Bel.US.CS@belf.com
belfuse.com/circuit-protection