

TOP VIEW

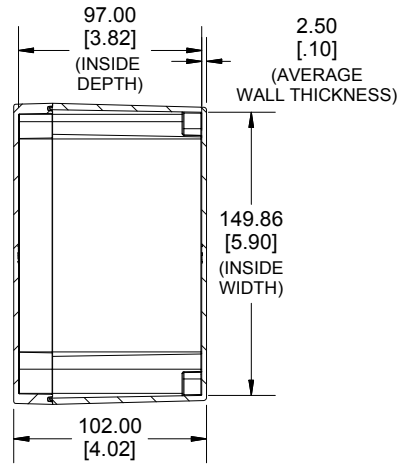

**SECTION A-A
END VIEW**

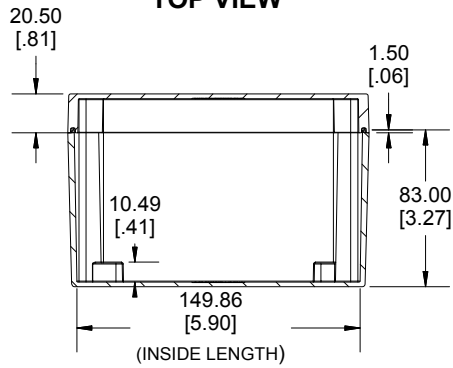

**SECTION B-B
SIDE VIEW**

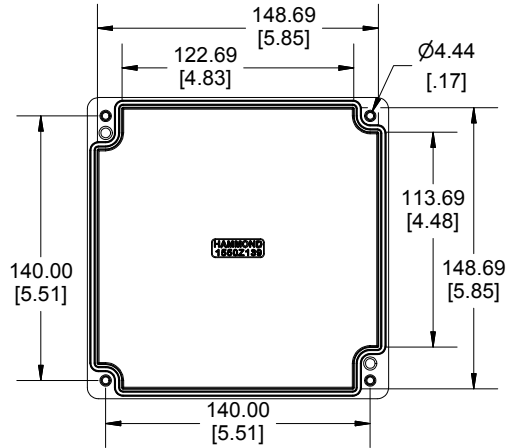

INSIDE LID

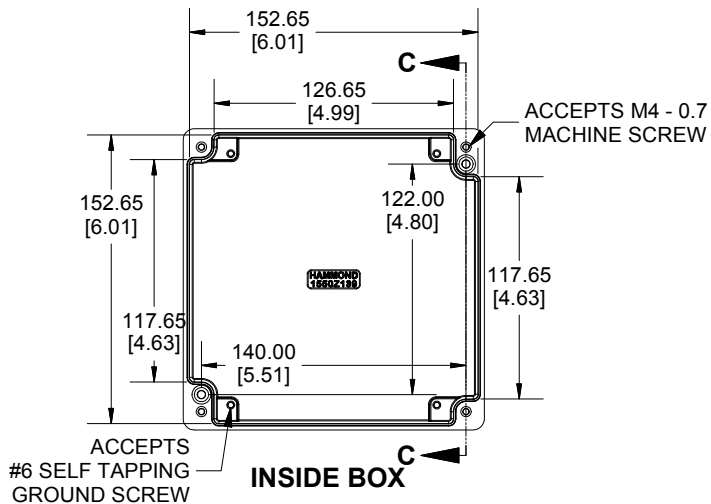

INSIDE BOX

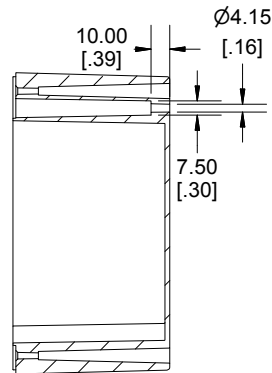

**SECTION C-C
MOUNTING HOLE**



Enclosures can be Factory Modified (Milling, Drilling, Printing etc.)
 Contact Factory mjm@hammondmfg.com for quotes
 Solid models of this enclosure available in STEP or IGES.
 (Part number and text placement/orientation on our products are subject to change,
 we do not recommend using them as a locating reference for modification purposes)

NOTE

Purchased assembly includes box, lid, silicone gasket, and 4 cover screws.
 Box and lid are made from Diecast Aluminum Alloy.

Screws should not be torqued past 5-7.5 lbf.in (50 -75 cN.m)

PART NUMBERS

1550Z139 Enclosure

Basic Enclosure

1550Z139

Black Enclosure

1550Z139BK

ACCESSORIES

Pre-Formed Silicone Gasket

1550Z139GASKET

**HAMMOND
MANUFACTURING**

1550Z139

www.hammondmfg.com

Dimensions:
mm
[inches]