

# NST3946DXV6

## Complementary General Purpose Transistor

The NST3946DXV6T1 device is a spin-off of our popular SOT-23/SOT-323 three-leaded device. It is designed for general purpose amplifier applications and is housed in the SOT-563 six-leaded surface mount package. By putting two discrete devices in one package, this device is ideal for low-power surface mount applications where board space is at a premium.

- $h_{FE}$ , 100–300
- Low  $V_{CE(sat)}$ ,  $\leq 0.4$  V
- Simplifies Circuit Design
- Reduces Board Space
- Reduces Component Count
- NSV Prefix for Automotive and Other Applications Requiring Unique Site and Control Change Requirements; AEC-Q101 Qualified and PPAP Capable
- These Devices are Pb-Free, Halogen Free/BFR Free and are RoHS Compliant

**Table 1. MAXIMUM RATINGS**

Rating	Symbol	Value	Unit
Collector–Emitter Voltage (NPN) (PNP)	$V_{CEO}$	40 –40	Vdc
Collector–Base Voltage (NPN) (PNP)	$V_{CBO}$	60 –40	Vdc
Emitter–Base Voltage (NPN) (PNP)	$V_{EBO}$	6.0 –5.0	Vdc
Collector Current – Continuous (NPN) (PNP)	$I_C$	200 –200	mAdc
Electrostatic Discharge	ESD	HBM>16000, MM>2000	V

Stresses exceeding those listed in the Maximum Ratings table may damage the device. If any of these limits are exceeded, device functionality should not be assumed, damage may occur and reliability may be affected.



**ON Semiconductor®**

<http://onsemi.com>



**SOT-563  
CASE 463A**

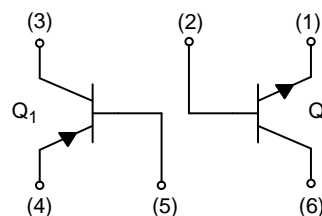

**NST3946DXV6T1\***

\*Q1 PNP  
Q2 NPN

### MARKING DIAGRAM



46 = Specific Device Code  
M = Date Code  
▪ = Pb-Free Package

(Note: Microdot may be in either location)

### ORDERING INFORMATION

Device	Package	Shipping†
NST3946DXV6T1G	SOT-563 (Pb-Free)	4,000 / Tape & Reel
NSVT3946DXV6T1G	SOT-563 (Pb-Free)	4,000 / Tape & Reel
NST3946DXV6T5G	SOT-563 (Pb-Free)	8,000 / Tape & Reel

†For information on tape and reel specifications, including part orientation and tape sizes, please refer to our Tape and Reel Packaging Specification Brochure, BRD8011/D.

# NST3946DXV6

**Table 2. THERMAL CHARACTERISTICS**

Characteristic (One Junction Heated)		Symbol	Max	Unit
Total Device Dissipation Derate above 25°C	$T_A = 25^\circ\text{C}$	$P_D$	357 (Note 1) 2.9 (Note 1)	mW mW/°C
Thermal Resistance Junction-to-Ambient		$R_{\theta JA}$	350 (Note 1)	°C/W
Characteristic (Both Junctions Heated)		Symbol	Max	Unit
Total Device Dissipation Derate above 25°C	$T_A = 25^\circ\text{C}$	$P_D$	500 (Note 1) 4.0 (Note 1)	mW mW/°C
Thermal Resistance Junction-to-Ambient		$R_{\theta JA}$	250 (Note 1)	°C/W
Junction and Storage Temperature Range		$T_J, T_{stg}$	55 to +150	°C

1. FR-4 @ Minimum Pad

**ELECTRICAL CHARACTERISTICS** ( $T_A = 25^\circ\text{C}$  unless otherwise noted)

Characteristic		Symbol	Min	Max	Unit
<b>OFF CHARACTERISTICS</b>					
Collector – Emitter Breakdown Voltage (Note 2) ( $I_C = 1.0\text{ mAdc}, I_B = 0$ ) ( $I_C = -1.0\text{ mAdc}, I_B = 0$ )	(NPN) (PNP)	$V_{(BR)CEO}$	40 -40	- -	Vdc
Collector – Base Breakdown Voltage ( $I_C = 10\text{ }\mu\text{Adc}, I_E = 0$ ) ( $I_C = -10\text{ }\mu\text{Adc}, I_E = 0$ )	(NPN) (PNP)	$V_{(BR)CBO}$	60 -40	- -	Vdc
Emitter – Base Breakdown Voltage ( $I_E = 10\text{ }\mu\text{Adc}, I_C = 0$ ) ( $I_E = -10\text{ }\mu\text{Adc}, I_C = 0$ )	(NPN) (PNP)	$V_{(BR)EBO}$	6.0 -5.0	- -	Vdc
Base Cutoff Current ( $V_{CE} = 30\text{ Vdc}, V_{EB} = 3.0\text{ Vdc}$ ) ( $V_{CE} = -30\text{ Vdc}, V_{EB} = -3.0\text{ Vdc}$ )	(NPN) (PNP)	$I_{BL}$	- -	50 -50	nAdc
Collector Cutoff Current ( $V_{CE} = 30\text{ Vdc}, V_{EB} = 3.0\text{ Vdc}$ ) ( $V_{CE} = -30\text{ Vdc}, V_{EB} = -3.0\text{ Vdc}$ )	(NPN) (PNP)	$I_{CEX}$	- -	50 -50	nAdc
<b>ON CHARACTERISTICS</b> (Note 2)					
DC Current Gain ( $I_C = 0.1\text{ mAdc}, V_{CE} = 1.0\text{ Vdc}$ ) ( $I_C = 1.0\text{ mAdc}, V_{CE} = 1.0\text{ Vdc}$ ) ( $I_C = 10\text{ mAdc}, V_{CE} = 1.0\text{ Vdc}$ ) ( $I_C = 50\text{ mAdc}, V_{CE} = 1.0\text{ Vdc}$ ) ( $I_C = 100\text{ mAdc}, V_{CE} = 1.0\text{ Vdc}$ )  ( $I_C = -0.1\text{ mAdc}, V_{CE} = -1.0\text{ Vdc}$ ) ( $I_C = -1.0\text{ mAdc}, V_{CE} = -1.0\text{ Vdc}$ ) ( $I_C = -10\text{ mAdc}, V_{CE} = -1.0\text{ Vdc}$ ) ( $I_C = -50\text{ mAdc}, V_{CE} = -1.0\text{ Vdc}$ ) ( $I_C = -100\text{ mAdc}, V_{CE} = -1.0\text{ Vdc}$ )	(NPN)     (PNP)	$h_{FE}$	40 70 100 60 30  60 80 100 60 30	- - 300 - -  - - 300 - -	-
Collector – Emitter Saturation Voltage ( $I_C = 10\text{ mAdc}, I_B = 1.0\text{ mAdc}$ ) ( $I_C = 50\text{ mAdc}, I_B = 5.0\text{ mAdc}$ )  ( $I_C = -10\text{ mAdc}, I_B = -1.0\text{ mAdc}$ ) ( $I_C = -50\text{ mAdc}, I_B = -5.0\text{ mAdc}$ )	(NPN)  (PNP)	$V_{CE(sat)}$	- -  -	0.2 0.3  -0.25 -0.4	Vdc
Base – Emitter Saturation Voltage ( $I_C = 10\text{ mAdc}, I_B = 1.0\text{ mAdc}$ ) ( $I_C = 50\text{ mAdc}, I_B = 5.0\text{ mAdc}$ )  ( $I_C = -10\text{ mAdc}, I_B = -1.0\text{ mAdc}$ ) ( $I_C = -50\text{ mAdc}, I_B = -5.0\text{ mAdc}$ )	(NPN)  (PNP)	$V_{BE(sat)}$	0.65 -  -0.65 -	0.85 0.95  -0.85 -0.95	Vdc

# NST3946DXV6

## ELECTRICAL CHARACTERISTICS (T<sub>A</sub> = 25°C unless otherwise noted) (continued)

Characteristic	Symbol	Min	Max	Unit
<b>SMALL-SIGNAL CHARACTERISTICS</b>				
Current-Gain – Bandwidth Product (I <sub>C</sub> = 10 mAdc, V <sub>CE</sub> = 20 Vdc, f = 100 MHz) (I <sub>C</sub> = -10 mAdc, V <sub>CE</sub> = -20 Vdc, f = 100 MHz)	f <sub>T</sub> (NPN) (PNP)	300 250	– –	MHz
Output Capacitance (V <sub>CB</sub> = 5.0 Vdc, I <sub>E</sub> = 0, f = 1.0 MHz) (V <sub>CB</sub> = -5.0 Vdc, I <sub>E</sub> = 0, f = 1.0 MHz)	C <sub>obo</sub> (NPN) (PNP)	– –	4.0 4.5	pF
Input Capacitance (V <sub>EB</sub> = 0.5 Vdc, I <sub>C</sub> = 0, f = 1.0 MHz) (V <sub>EB</sub> = -0.5 Vdc, I <sub>C</sub> = 0, f = 1.0 MHz)	C <sub>ibo</sub> (NPN) (PNP)	– –	8.0 10.0	pF
Input Impedance (V <sub>CE</sub> = 10 Vdc, I <sub>C</sub> = 1.0 mAdc, f = 1.0 kHz) (V <sub>CE</sub> = -10 Vdc, I <sub>C</sub> = -1.0 mAdc, f = 1.0 kHz)	h <sub>ie</sub> (NPN) (PNP)	1.0 2.0	10 12	k Ω
Voltage Feedback Ratio (V <sub>CE</sub> = 10 Vdc, I <sub>C</sub> = 1.0 mAdc, f = 1.0 kHz) (V <sub>CE</sub> = -10 Vdc, I <sub>C</sub> = -1.0 mAdc, f = 1.0 kHz)	h <sub>re</sub> (NPN) (PNP)	0.5 0.1	8.0 10	X 10 <sup>-4</sup>
Small-Signal Current Gain (V <sub>CE</sub> = 10 Vdc, I <sub>C</sub> = 1.0 mAdc, f = 1.0 kHz) (V <sub>CE</sub> = -10 Vdc, I <sub>C</sub> = -1.0 mAdc, f = 1.0 kHz)	h <sub>fe</sub> (NPN) (PNP)	100 100	400 400	–
Output Admittance (V <sub>CE</sub> = 10 Vdc, I <sub>C</sub> = 1.0 mAdc, f = 1.0 kHz) (V <sub>CE</sub> = -10 Vdc, I <sub>C</sub> = -1.0 mAdc, f = 1.0 kHz)	h <sub>oe</sub> (NPN) (PNP)	1.0 3.0	40 60	μmhos
Noise Figure (V <sub>CE</sub> = 5.0 Vdc, I <sub>C</sub> = 100 μAdc, R <sub>S</sub> = 1.0 k Ω, f = 1.0 kHz) (V <sub>CE</sub> = -5.0 Vdc, I <sub>C</sub> = -100 μAdc, R <sub>S</sub> = 1.0 k Ω, f = 1.0 kHz)	NF (NPN) (PNP)	– –	5.0 4.0	dB

## SWITCHING CHARACTERISTICS

Delay Time (V <sub>CC</sub> = 3.0 Vdc, V <sub>BE</sub> = -0.5 Vdc) (V <sub>CC</sub> = -3.0 Vdc, V <sub>BE</sub> = 0.5 Vdc)	t <sub>d</sub> (NPN) (PNP)	– –	35 35	ns
Rise Time (I <sub>C</sub> = 10 mAdc, I <sub>B1</sub> = 1.0 mAdc) (I <sub>C</sub> = -10 mAdc, I <sub>B1</sub> = -1.0 mAdc)	t <sub>r</sub> (NPN) (PNP)	– –	35 35	ns
Storage Time (V <sub>CC</sub> = 3.0 Vdc, I <sub>C</sub> = 10 mAdc) (V <sub>CC</sub> = -3.0 Vdc, I <sub>C</sub> = -10 mAdc)	t <sub>s</sub> (NPN) (PNP)	– –	200 225	ns
Fall Time (I <sub>B1</sub> = I <sub>B2</sub> = 1.0 mAdc) (I <sub>B1</sub> = I <sub>B2</sub> = -1.0 mAdc)	t <sub>f</sub> (NPN) (PNP)	– –	50 75	ns

Product parametric performance is indicated in the Electrical Characteristics for the listed test conditions, unless otherwise noted. Product performance may not be indicated by the Electrical Characteristics if operated under different conditions.

2. Pulse Test: Pulse Width ≤ 300 μs; Duty Cycle ≤ 2.0%.

# NST3946DXV6

(NPN)

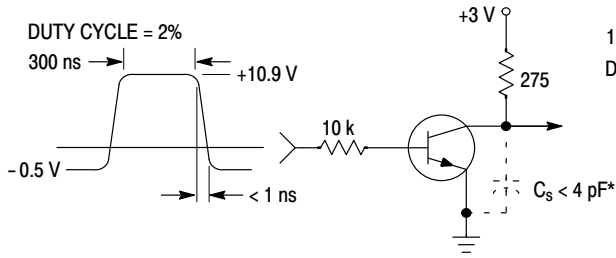

Figure 1. Delay and Rise Time Equivalent Test Circuit

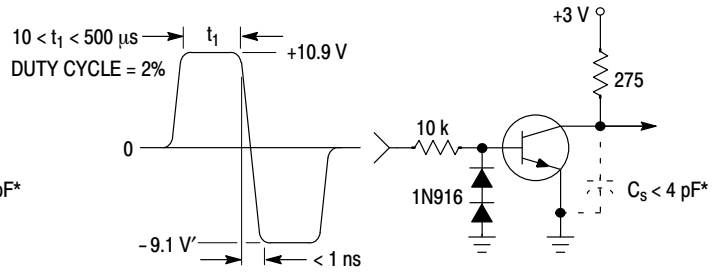

Figure 2. Storage and Fall Time Equivalent Test Circuit

\* Total shunt capacitance of test jig and connectors

## TYPICAL TRANSIENT CHARACTERISTICS

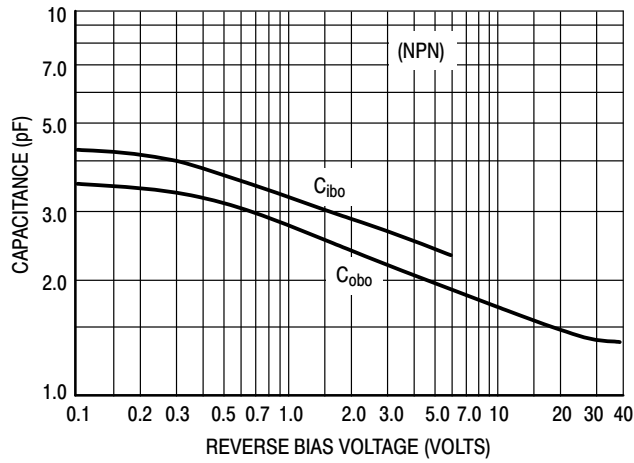

Figure 3. Capacitance

# NST3946DXV6

(NPN)

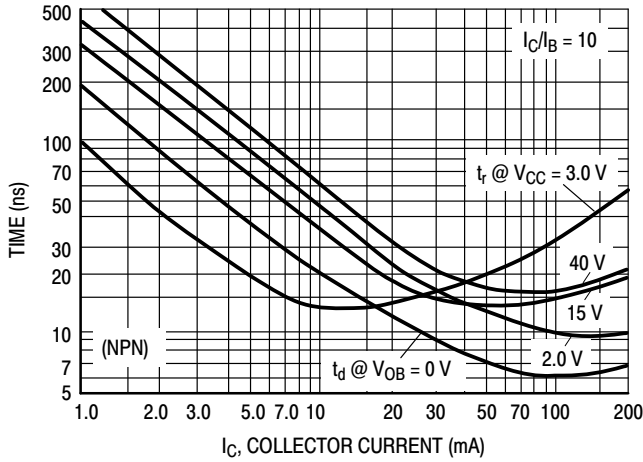

Figure 4. Turn-On Time

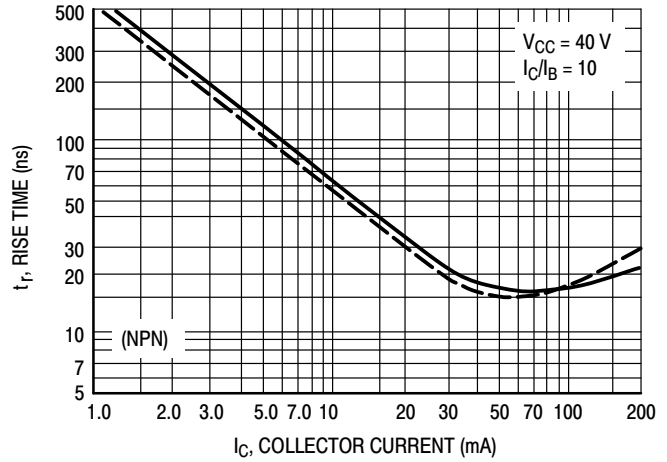

Figure 5. Rise Time

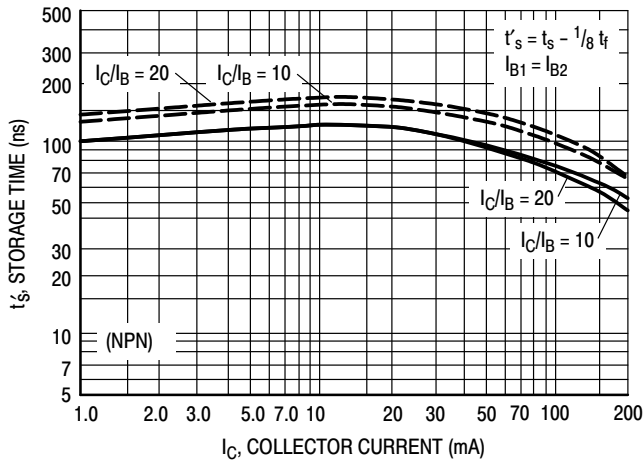

Figure 6. Storage Time

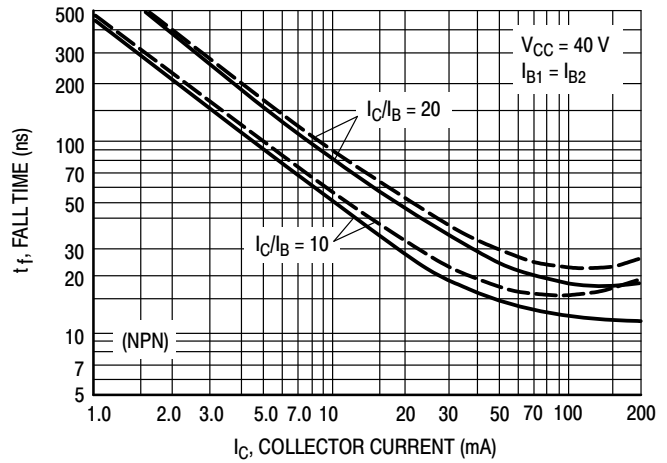

Figure 7. Fall Time

## TYPICAL AUDIO SMALL-SIGNAL CHARACTERISTICS NOISE FIGURE VARIATIONS

( $V_{CE} = 5.0 \text{ Vdc}$ ,  $T_A = 25^\circ\text{C}$ , Bandwidth = 1.0 Hz)

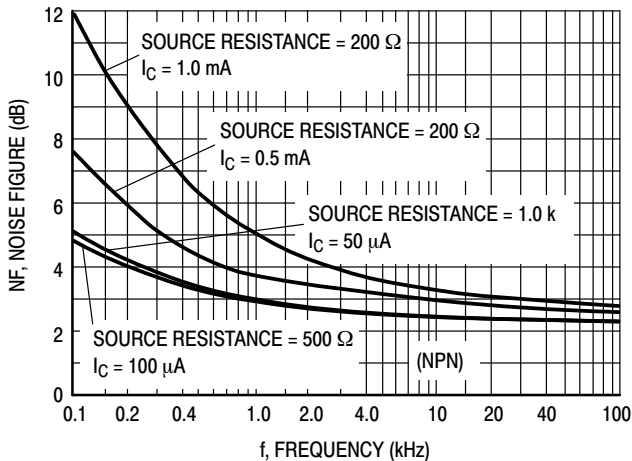

Figure 8. Noise Figure

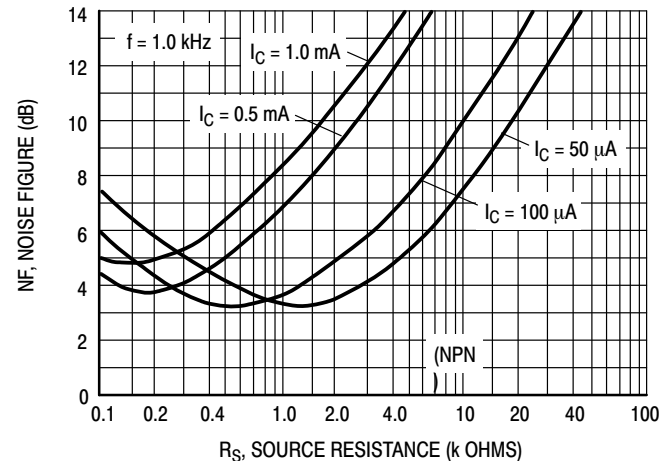

Figure 9. Noise Figure

# NST3946DXV6

(NPN)

## h PARAMETERS

( $V_{CE} = 10 \text{ Vdc}$ ,  $f = 1.0 \text{ kHz}$ ,  $T_A = 25^\circ\text{C}$ )

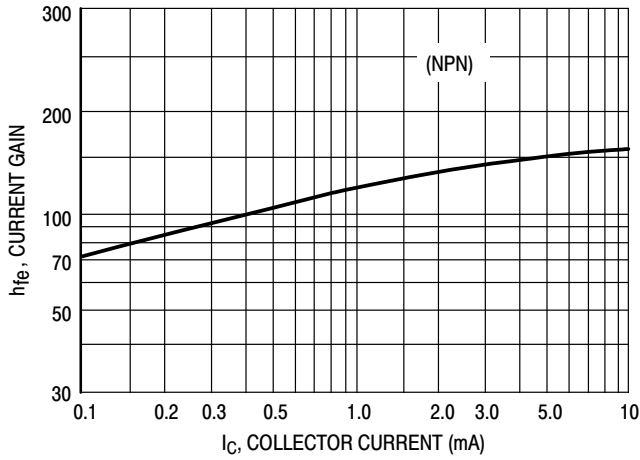

Figure 10. Current Gain

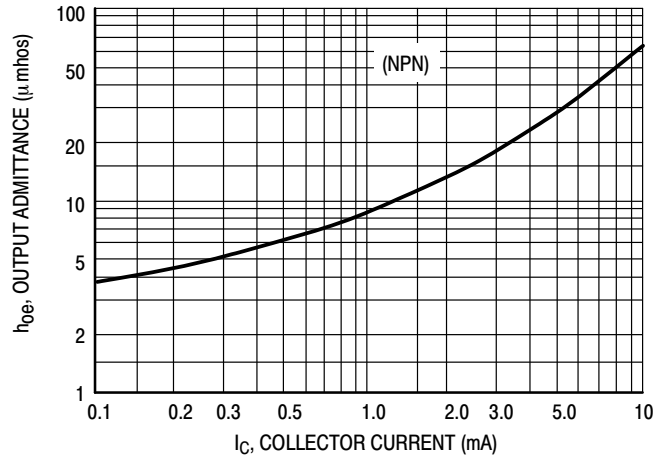

Figure 11. Output Admittance

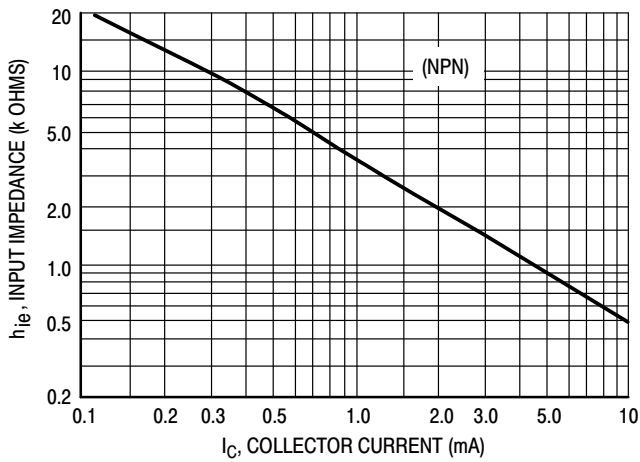

Figure 12. Input Impedance

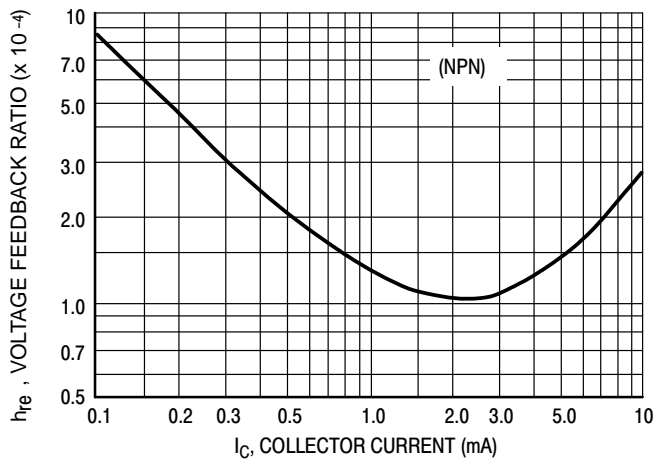

Figure 13. Voltage Feedback Ratio

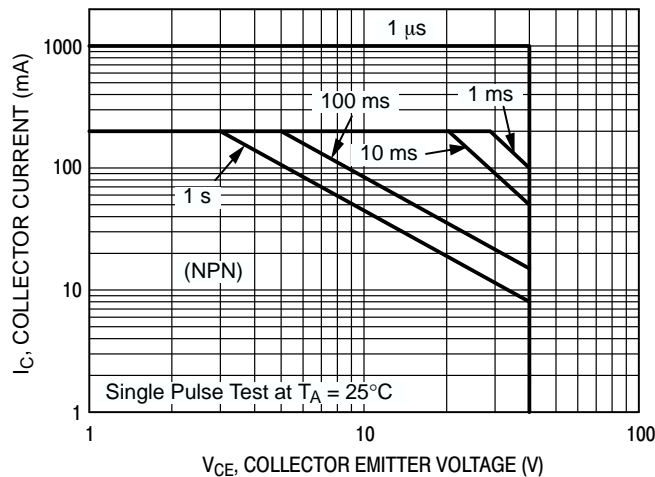

Figure 14. Safe Operating Area

# NST3946DXV6

(NPN)

## TYPICAL STATIC CHARACTERISTICS

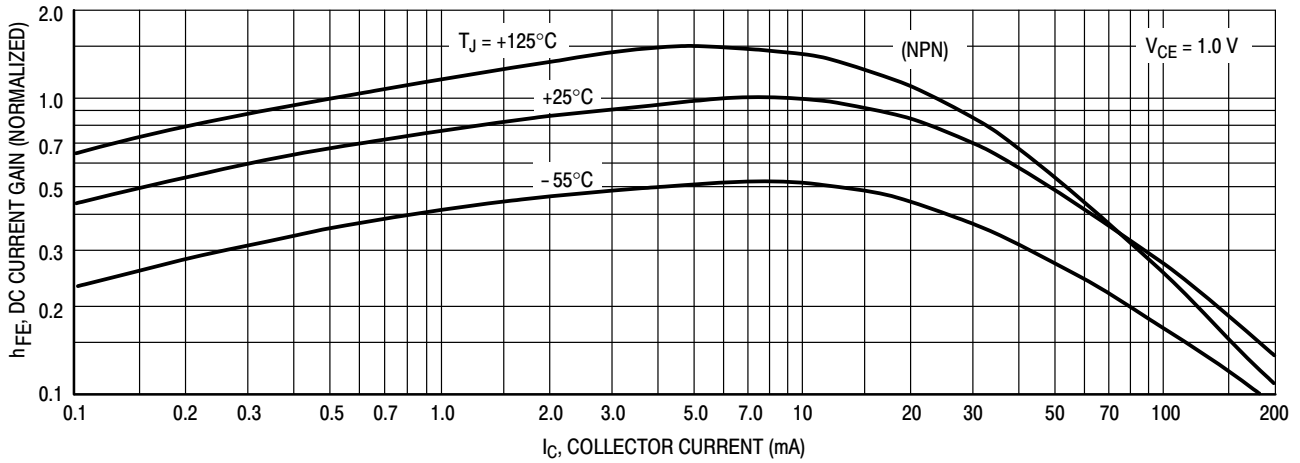

Figure 15. DC Current Gain

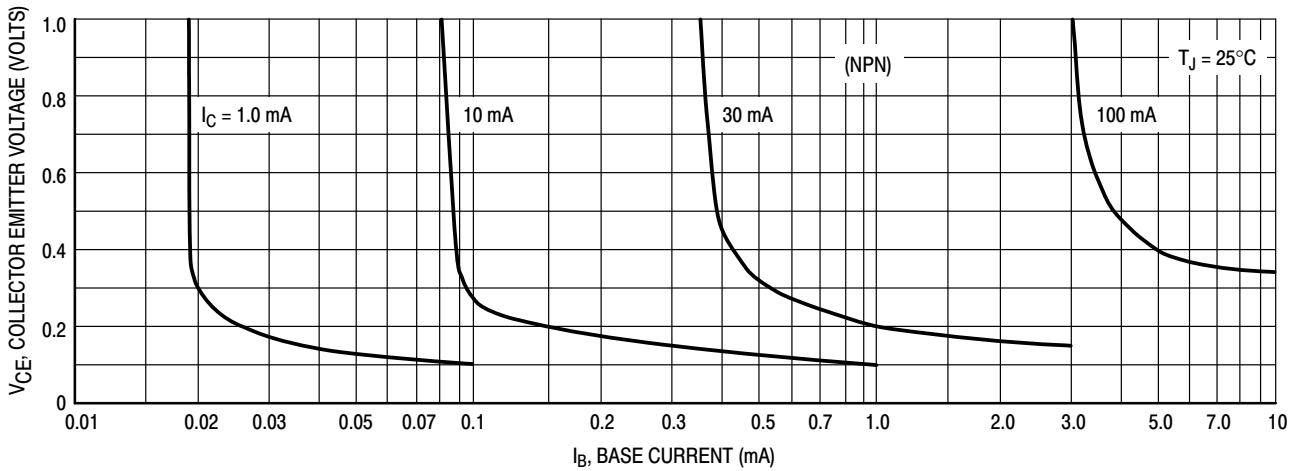

Figure 16. Collector Saturation Region

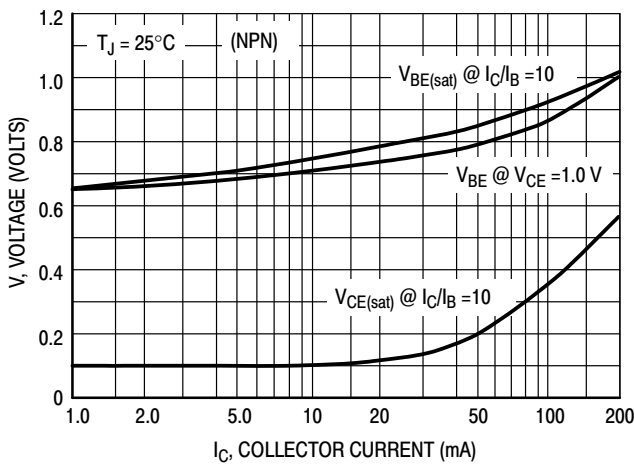

Figure 17. "ON" Voltages

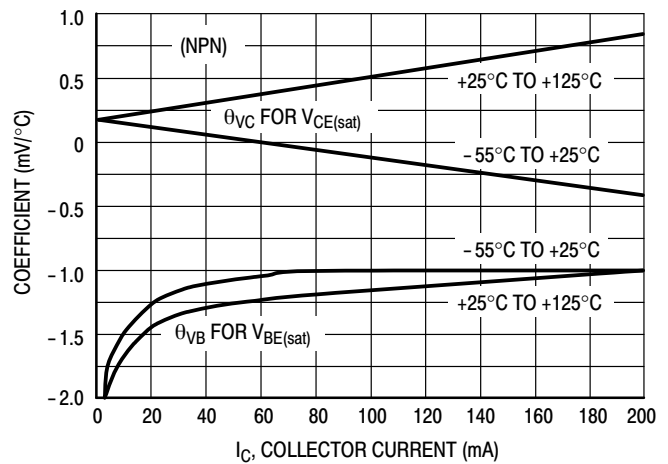

Figure 18. Temperature Coefficients

# NST3946DXV6

(PNP)

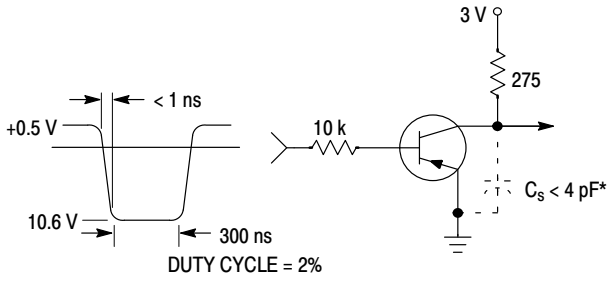

Figure 19. Delay and Rise Time Equivalent Test Circuit

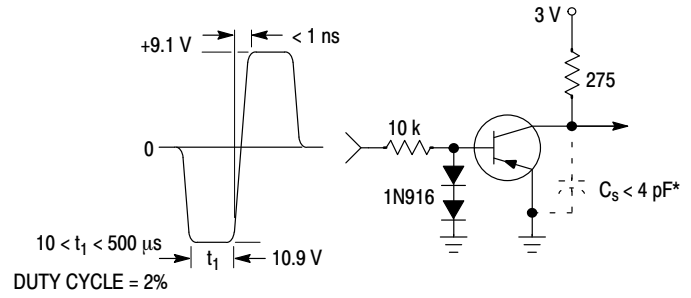

Figure 20. Storage and Fall Time Equivalent Test Circuit

\* Total shunt capacitance of test jig and connectors

## TYPICAL TRANSIENT CHARACTERISTICS

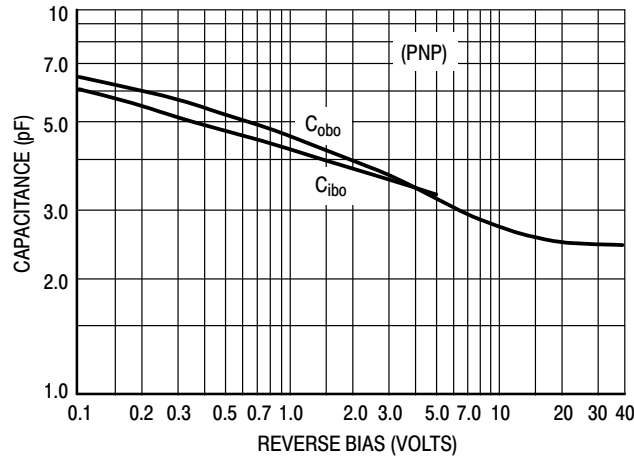

Figure 21. Capacitance

—  $T_J = 25^\circ\text{C}$   
 - - -  $T_J = 125^\circ\text{C}$

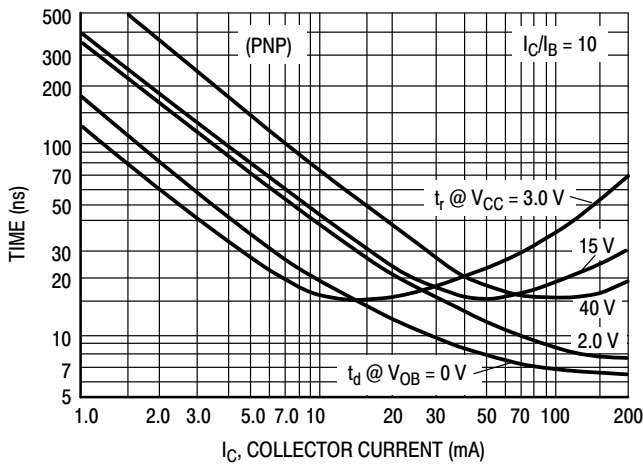

Figure 22. Turn-On Time

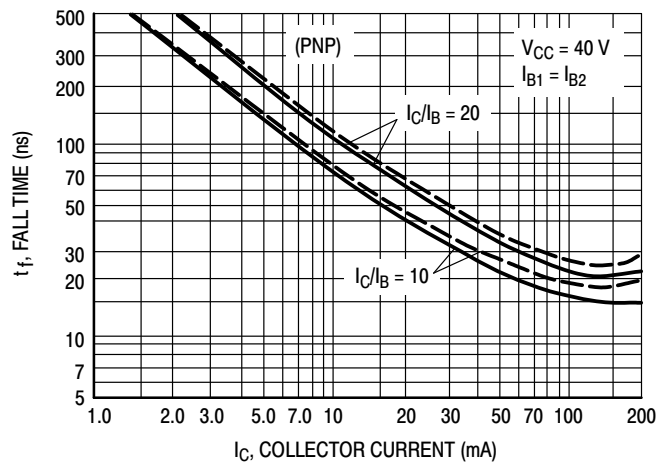

Figure 23. Fall Time



# NST3946DXV6

(PNP)

## TYPICAL AUDIO SMALL-SIGNAL CHARACTERISTICS NOISE FIGURE VARIATIONS

( $V_{CE} = -5.0$  Vdc,  $T_A = 25^\circ\text{C}$ , Bandwidth = 1.0 Hz)

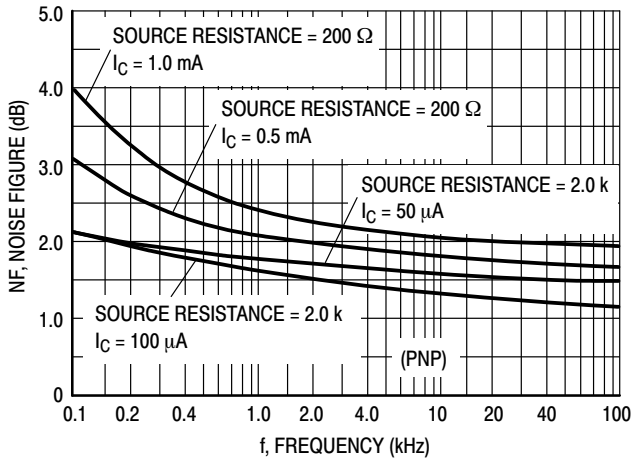

Figure 24.

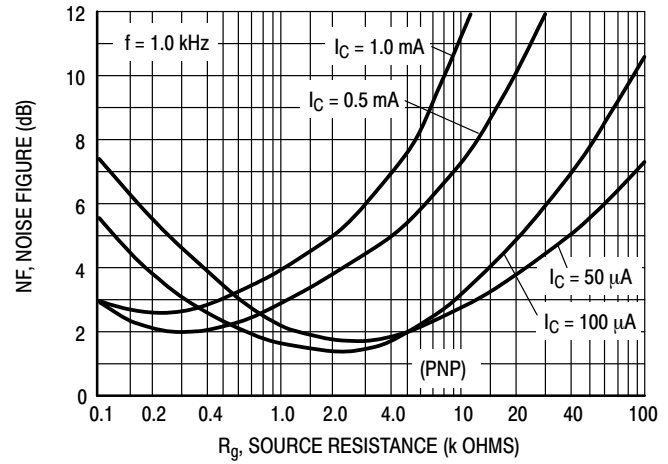

Figure 25.

## h PARAMETERS

( $V_{CE} = -10$  Vdc,  $f = 1.0$  kHz,  $T_A = 25^\circ\text{C}$ )

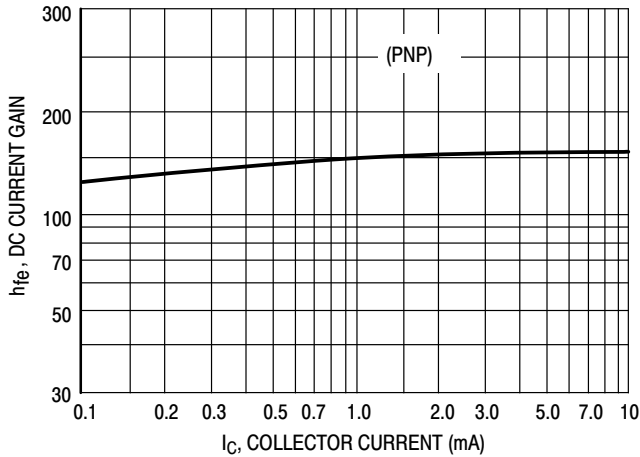

Figure 26. Current Gain

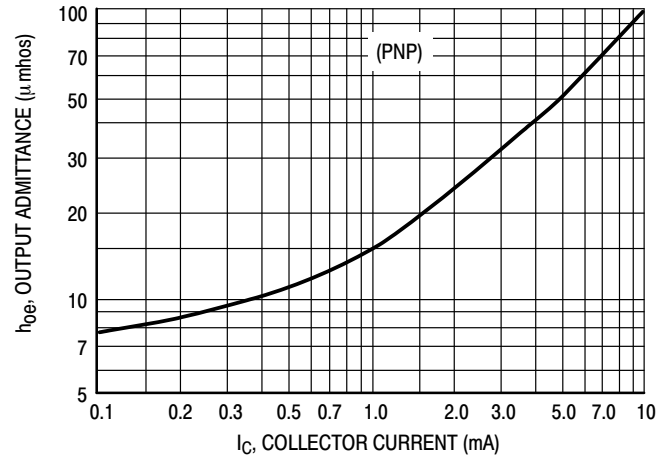

Figure 27. Output Admittance

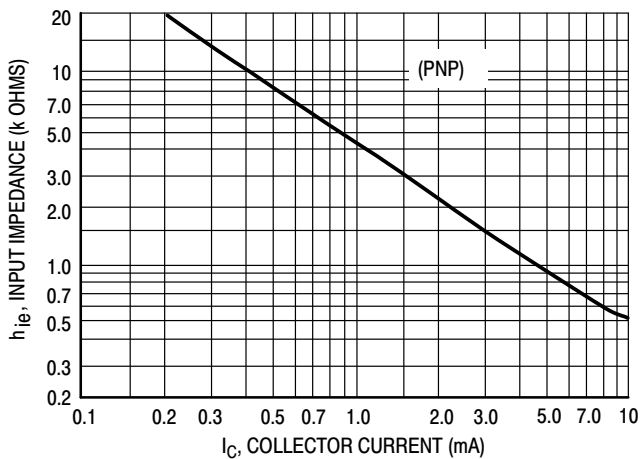

Figure 28. Input Impedance

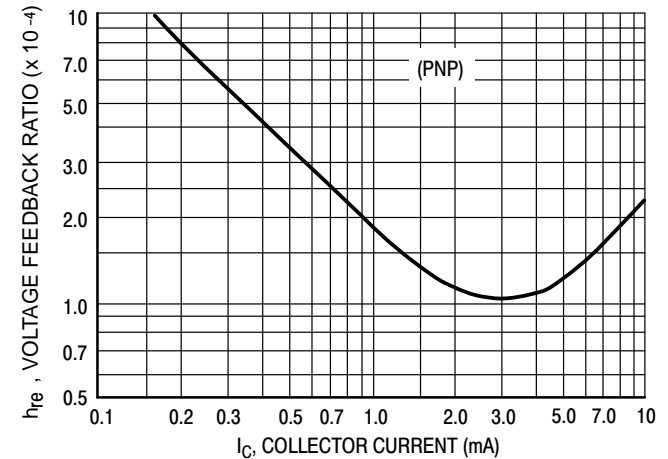

Figure 29. Voltage Feedback Ratio

# NST3946DXV6

(PNP)

## TYPICAL STATIC CHARACTERISTICS

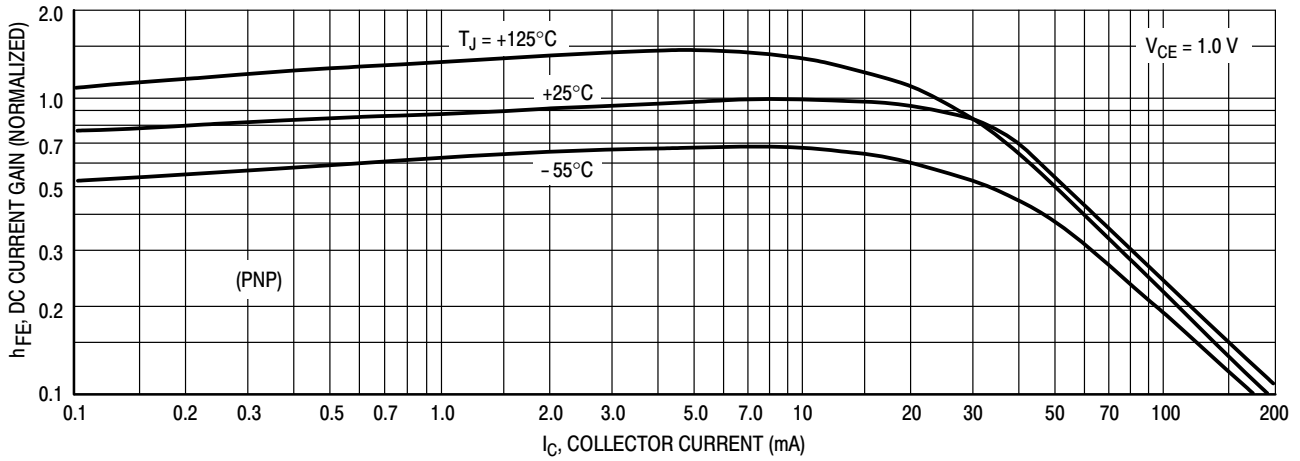

Figure 30. DC Current Gain

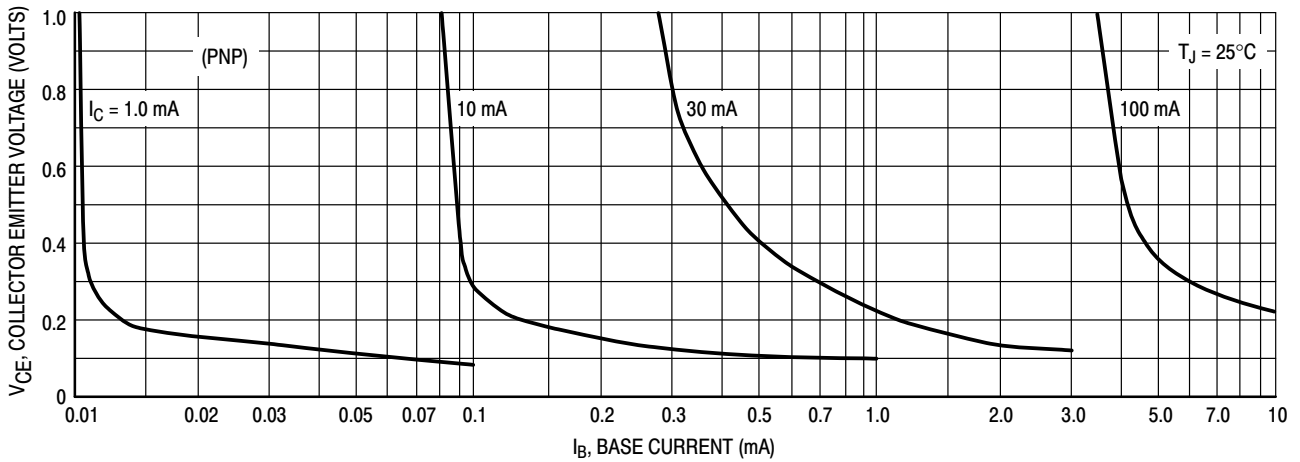

Figure 31. Collector Saturation Region

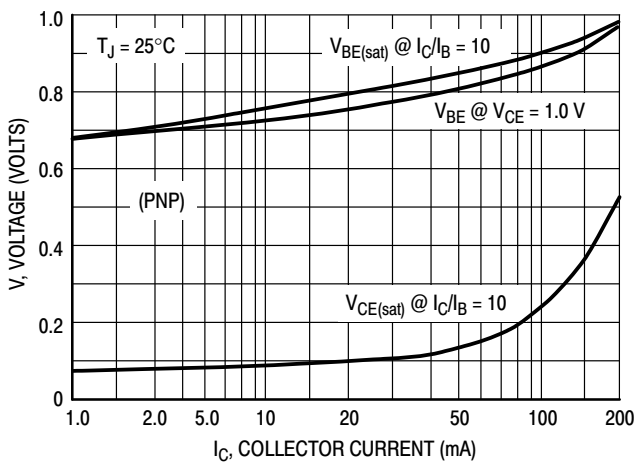

Figure 32. "ON" Voltages

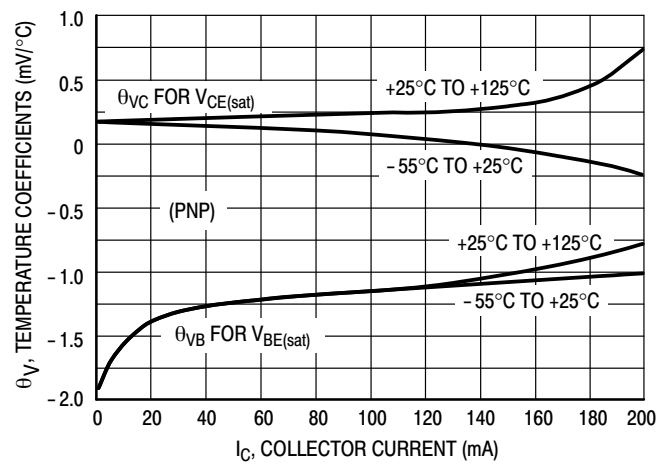

Figure 33. Temperature Coefficients

# NST3946DXV6

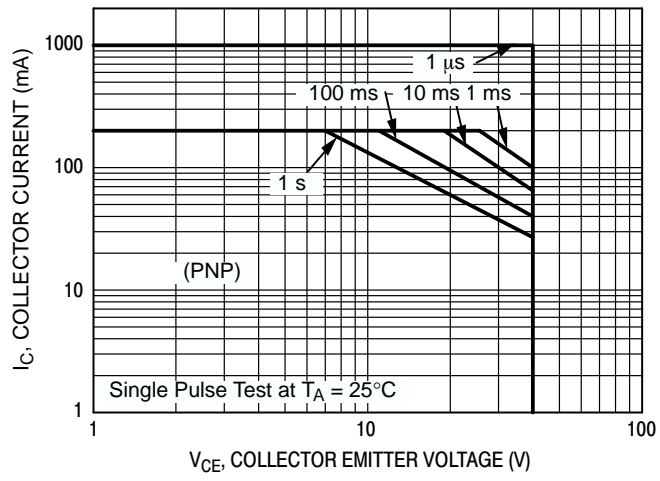

Figure 34. Safe Operating Area

# MECHANICAL CASE OUTLINE

## PACKAGE DIMENSIONS

ON Semiconductor®



SCALE 4:1

**SOT-563, 6 LEAD**  
CASE 463A  
ISSUE H

DATE 26 JAN 2021

**NOTES:**

1. DIMENSIONING AND TOLERANCING PER ASME Y14.5M, 2009.
2. CONTROLLING DIMENSION: MILLIMETERS
3. MAXIMUM LEAD THICKNESS INCLUDES LEAD FINISH THICKNESS. MINIMUM LEAD THICKNESS IS THE MINIMUM THICKNESS OF BASE MATERIAL.

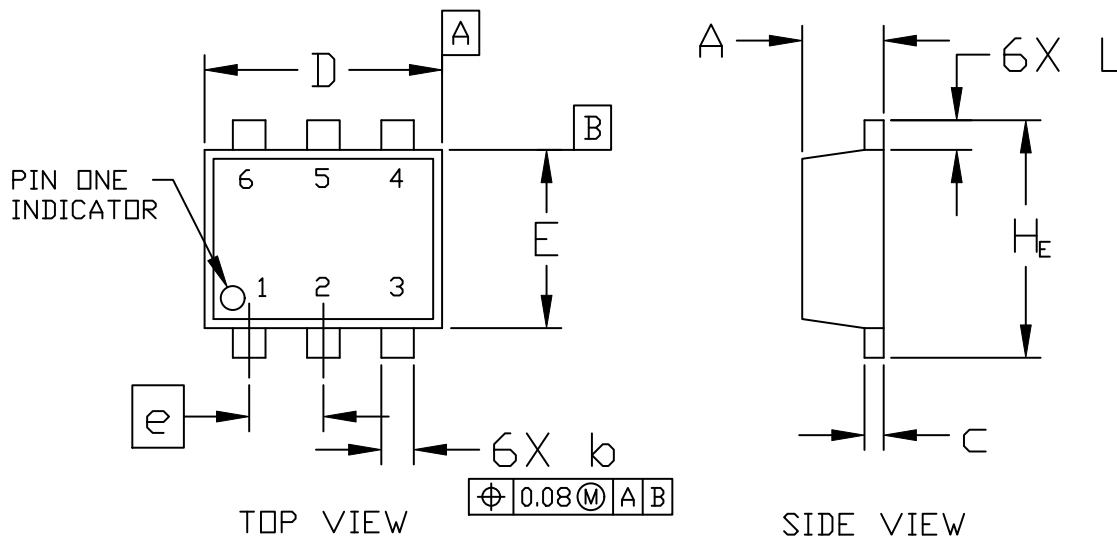

DIM	MILLIMETERS		
	MIN.	NOM.	MAX.
A	0.50	0.55	0.60
b	0.17	0.22	0.27
c	0.08	0.13	0.18
D	1.50	1.60	1.70
E	1.10	1.20	1.30
e	0.50 BSC		
L	0.10	0.20	0.30
H <sub>E</sub>	1.50	1.60	1.70

**RECOMMENDED MOUNTING FOOTPRINT\***

\* For additional information on our Pb-Free strategy and soldering details, please download the ON Semiconductor Soldering and Mounting Techniques Reference Manual, SOLDERRM/D.

<b>DOCUMENT NUMBER:</b>	<b>98AON11126D</b>	Electronic versions are uncontrolled except when accessed directly from the Document Repository. Printed versions are uncontrolled except when stamped "CONTROLLED COPY" in red.
<b>DESCRIPTION:</b>	<b>SOT-563, 6 LEAD</b>	<b>PAGE 1 OF 2</b>

ON Semiconductor and are trademarks of Semiconductor Components Industries, LLC dba ON Semiconductor or its subsidiaries in the United States and/or other countries. ON Semiconductor reserves the right to make changes without further notice to any products herein. ON Semiconductor makes no warranty, representation or guarantee regarding the suitability of its products for any particular purpose, nor does ON Semiconductor assume any liability arising out of the application or use of any product or circuit, and specifically disclaims any and all liability, including without limitation special, consequential or incidental damages. ON Semiconductor does not convey any license under its patent rights nor the rights of others.

**SOT-563, 6 LEAD**  
CASE 463A  
ISSUE H

DATE 26 JAN 2021

STYLE 1:  
PIN 1. EMITTER 1  
2. BASE 1  
3. COLLECTOR 2  
4. EMITTER 2  
5. BASE 2  
6. COLLECTOR 1

STYLE 2:  
PIN 1. EMITTER 1  
2. EMITTER 2  
3. BASE 2  
4. COLLECTOR 2  
5. BASE 1  
6. COLLECTOR 1

STYLE 3:  
PIN 1. CATHODE 1  
2. CATHODE 1  
3. ANODE/ANODE 2  
4. CATHODE 2  
5. CATHODE 2  
6. ANODE/ANODE 1

STYLE 4:  
PIN 1. COLLECTOR  
2. COLLECTOR  
3. BASE  
4. EMITTER  
5. COLLECTOR  
6. COLLECTOR

STYLE 5:  
PIN 1. CATHODE  
2. CATHODE  
3. ANODE  
4. ANODE  
5. CATHODE  
6. CATHODE

STYLE 6:  
PIN 1. CATHODE  
2. ANODE  
3. CATHODE  
4. CATHODE  
5. CATHODE  
6. CATHODE

STYLE 7:  
PIN 1. CATHODE  
2. ANODE  
3. CATHODE  
4. CATHODE  
5. ANODE  
6. CATHODE

STYLE 8:  
PIN 1. DRAIN  
2. DRAIN  
3. GATE  
4. SOURCE  
5. DRAIN  
6. DRAIN

STYLE 9:  
PIN 1. SOURCE 1  
2. GATE 1  
3. DRAIN 2  
4. SOURCE 2  
5. GATE 2  
6. DRAIN 1

STYLE 10:  
PIN 1. CATHODE 1  
2. N/C  
3. CATHODE 2  
4. ANODE 2  
5. N/C  
6. ANODE 1

STYLE 11:  
PIN 1. EMITTER 2  
2. BASE 2  
3. COLLECTOR 1  
4. EMITTER 1  
5. BASE 1  
6. COLLECTOR 2

**GENERIC  
MARKING DIAGRAM\***

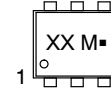

XX = Specific Device Code  
M = Month Code  
■ = Pb-Free Package

\*This information is generic. Please refer to device data sheet for actual part marking. Pb-Free indicator, "G" or microdot "■", may or may not be present. Some products may not follow the Generic Marking.

<b>DOCUMENT NUMBER:</b>	<b>98AON11126D</b>	Electronic versions are uncontrolled except when accessed directly from the Document Repository. Printed versions are uncontrolled except when stamped "CONTROLLED COPY" in red.
<b>DESCRIPTION:</b>	<b>SOT-563, 6 LEAD</b>	<b>PAGE 2 OF 2</b>

ON Semiconductor and are trademarks of Semiconductor Components Industries, LLC dba ON Semiconductor or its subsidiaries in the United States and/or other countries. ON Semiconductor reserves the right to make changes without further notice to any products herein. ON Semiconductor makes no warranty, representation or guarantee regarding the suitability of its products for any particular purpose, nor does ON Semiconductor assume any liability arising out of the application or use of any product or circuit, and specifically disclaims any and all liability, including without limitation special, consequential or incidental damages. ON Semiconductor does not convey any license under its patent rights nor the rights of others.

**onsemi**, **Onsemi**, and other names, marks, and brands are registered and/or common law trademarks of Semiconductor Components Industries, LLC dba "**onsemi**" or its affiliates and/or subsidiaries in the United States and/or other countries. **onsemi** owns the rights to a number of patents, trademarks, copyrights, trade secrets, and other intellectual property. A listing of **onsemi**'s product/patent coverage may be accessed at [www.onsemi.com/site/pdf/Patent-Marking.pdf](http://www.onsemi.com/site/pdf/Patent-Marking.pdf). **onsemi** reserves the right to make changes at any time to any products or information herein, without notice. The information herein is provided "as-is" and **onsemi** makes no warranty, representation or guarantee regarding the accuracy of the information, product features, availability, functionality, or suitability of its products for any particular purpose, nor does **onsemi** assume any liability arising out of the application or use of any product or circuit, and specifically disclaims any and all liability, including without limitation special, consequential or incidental damages. Buyer is responsible for its products and applications using **onsemi** products, including compliance with all laws, regulations and safety requirements or standards, regardless of any support or applications information provided by **onsemi**. "Typical" parameters which may be provided in **onsemi** data sheets and/or specifications can and do vary in different applications and actual performance may vary over time. All operating parameters, including "Typicals" must be validated for each customer application by customer's technical experts. **onsemi** does not convey any license under any of its intellectual property rights nor the rights of others. **onsemi** products are not designed, intended, or authorized for use as a critical component in life support systems or any FDA Class 3 medical devices or medical devices with a same or similar classification in a foreign jurisdiction or any devices intended for implantation in the human body. Should Buyer purchase or use **onsemi** products for any such unintended or unauthorized application, Buyer shall indemnify and hold **onsemi** and its officers, employees, subsidiaries, affiliates, and distributors harmless against all claims, costs, damages, and expenses, and reasonable attorney fees arising out of, directly or indirectly, any claim of personal injury or death associated with such unintended or unauthorized use, even if such claim alleges that **onsemi** was negligent regarding the design or manufacture of the part. **onsemi** is an Equal Opportunity/Affirmative Action Employer. This literature is subject to all applicable copyright laws and is not for resale in any manner.

## PUBLICATION ORDERING INFORMATION

### LITERATURE FULFILLMENT:

Email Requests to: [orderlit@onsemi.com](mailto:orderlit@onsemi.com)

**onsemi Website:** [www.onsemi.com](http://www.onsemi.com)

### TECHNICAL SUPPORT

**North American Technical Support:**  
Voice Mail: 1 800-282-9855 Toll Free USA/Canada  
Phone: 011 421 33 790 2910

**Europe, Middle East and Africa Technical Support:**

Phone: 00421 33 790 2910

For additional information, please contact your local Sales Representative