

Middle Power Class-D Speaker Amplifiers

Analog Input / BTL Output

Class-D Speaker Amplifier



BD5413EFV

No.10075EBT01

●Description

BD5413EFV is a 5W + 5W stereo class-D power amplifier specifically developed for low power consumption and low heat generation applications like powered speakers. BD5413EFV employs the state-of-the-art BCD (Bipolar, CMOS and DMOS) process technology to eliminate a turn-on resistance in the output power stage and an internal loss due to a wiring resistance as much as possible, achieving a high performance of 80% (4W + 4W output with a load resistance of 8Ω). In addition, BD5413EFV employs a compact power package which dissipates heat via the rear to achieve low power consumption and low heat generation so that the need for connecting an external heat radiator can be eliminated up to a total output of 12.8W. This product meets the needs for compact, thin sound generation systems and powerful, high-quality sound reproduction.

●Features

- 1) Small output noise voltage capable of achieving a high S/N set
Input conversion noise voltage = $2.8\mu\text{Vrms}$
A bipolar differential is used for input amplifier to eliminate 1/f noise.
- 2) Support of power supply voltage ranging from 6V to 10.5V
A supply voltage range is supported that matches an AC adaptor or battery cell driven set.
When a set is battery driven, its operating time can be extended by means of a high performance class-D amplifier.
- 3) Support of low current consumption mode
A circuit current in shut-down mode is $1\mu\text{A}$ or less.
- 4) Built-in soft muting function for reducing pop at shut-down ON or OFF
When a signal is present, its smooth envelope waveform is realized owing to this function.
In addition, when no signal is present, pop generation is eliminated.
A transit time can be adjusted easily through the use of an external capacitor.
- 5) Realization of high efficiency and low heat generation
Efficiency = 80% (4W+4W ($V_{CC}=9\text{V}$, $R_L=8\Omega$) output can be made without using an external heat radiator.)
A compact power package HTSSOP-B24 (7.8mm x 7.6mm) is employed.
- 6) Built-in function for reducing pop generation at disconnection from the outlet
- 7) Support of function for sampling frequency selection
An internal PWM sampling frequency can be selected from three frequencies (200kHz, 250kHz and 300kHz).
Countermeasures against interference (beat noise) due to a switching power source can be taken as needed.
- 8) Realization of high reliability
Countermeasures against short-circuits due to output terminals shorted to V_{CC} or ground can be taken (support of automatic recovery).
A temperature protection circuit is incorporated (support of automatic recovery).
- 9) Support of ERROR pin
ERROR output takes place as a warning which indicates an error.
(short-circuits due to output terminals shorted to V_{CC} or ground, or IC high temperature abnormality).

● Absolute maximum ratings

A circuit must be designed and evaluated not to exceed absolute maximum rating in any cases and even momentarily, to prevent reduction in functional performances and thermal destruction of a semiconductor product and secure useful life and reliability.

The following values assume $T_a = 25^\circ\text{C}$. For latest values, refer to delivery specifications.

Parameter	Symbol	Ratings	Unit	Conditions
Supply voltage	V _{CC}	+15	V	Pin 3, 5, 10, 12, 16, 21 (Note 1,2)
Power dissipation	P _d	1.1	W	(Note 3)
		2.8	W	(Note 4)
Input voltage for signal pin	V _{IN}	-0.2 to V _{CC} +0.2	V	Pin 23, 24 (Note 1)
Input voltage for control pin	V _{CONT}	-0.2 to V _{CC} +0.2	V	Pin 14, 15 (Note 1)
Operating temperature range	T _{opr}	-40 to +85	°C	
Storage temperature range	T _{stg}	-55 to +150	°C	
Maximum junction temperature	T _{jmax}	+150	°C	

(Note 1) A voltage that can be applied with reference to GND (pins 1, 7, 8, 13, 18 and 19)

(Note 2) P_d and T_{jmax}=150°C must not be exceeded.

(Note 3) 70mm × 70mm × 1.6mm FR4 One-sided glass epoxy board (Back copper foil 0%) installed.

If used under $T_a=25^\circ\text{C}$ or higher, reduce 8.8 mW for increase of every 1°C. The board is provided with thermal via.

(Note 4) 70mm × 70mm × 1.6mm FR4 Both-sided glass epoxy board (Back copper foil 100%) installed.

If used under $T_a=25^\circ\text{C}$ or higher, reduce 22.4 mW for increase of every 1°C. The board is provided with thermal via.

● Operating conditions

The temperature (T_a) is 25°C. For the latest temperature, refer to the delivery specifications.

Parameter	Symbol	Ratings	Unit	Conditions
Supply voltage	V _{CC}	+6 to +10.5	V	Pin 3, 5, 10, 12, 16, 21
Load resistance	R _L	6 to 16	Ω	(Note 5)

(Note 5) This value must not exceed P_d.

● Electrical characteristics

Unless otherwise stated, $T_a=25^\circ\text{C}$, V_{CC}=9V, f_{IN}=1kHz, R_g=0Ω, R_L=8Ω, SDX="H" and FC="M (OPEN)" are assumed. For the latest values, refer to the delivery specifications.

Parameter	Symbol	Limits	Unit	Conditions
Whole circuit				
Circuit current 1 (sampling mode)	I _{CC1}	12	mA	No signal, no load
Circuit current 2 (mute mode)	I _{CC2}	1	μA	SDX = "L"
Control				
Input voltage with SDX pin set to "H"	V _{IHSDX}	2.5 to 9	V	Sampling state
Input voltage with SDX pin set to "L"	V _{ILSDX}	0 to 0.5	V	Shut-down state
Input voltage with FC pin set to "H"	V _{IHFC}	8.2 to 9	V	Setting of F _s =300kHz
Input voltage with FC pin set to "M"	V _{IMFC}	3.8 to 5.2	V	Setting of F _s =250kHz
Input voltage with FC pin set to "L"	V _{ILFC}	0 to 0.8	V	Setting of F _s =200kHz
Audio output				
Voltage gain	G _V	30	dB	P _o = 1W
Maximum output power 1 (Note 6)	P _{O1}	4	W	THD+N = 10%, R _L = 8Ω
Maximum output power 2 (Note 6)	P _{O2}	5	W	THD+N = 10%, R _L = 6Ω
Total harmonic distortion ratio (Note 6)	THD	0.2	%	P _o = 1W, BW=20Hz to 20kHz
Crosstalk	CT	65	dB	P _o = 1W, R _g = 0Ω, BW = IHF-A
Output noise voltage (sampling mode)	V _{NO}	90	μV _{rms}	R _g = 0Ω, BW = IHF-A
Residual noise voltage (mute mode)	V _{NOM}	1	μV _{rms}	R _g = 0Ω, BW = IHF-A, MUTEX = "L"
Internal sampling clock frequency	F _s	200	kHz	FC = L FC = M(OPEN) FC = H
		250		
		300		

(Note 6) The rated values of items above indicate average performances of the device, which largely depend on circuit layouts, components, and power supplies. The reference values are those applicable to the device and components directly installed on a board specified by us.

●Electrical characteristic curves (Ta=25°C) (Reference data)

(1) Under Stereo Operation (RL=8Ω)

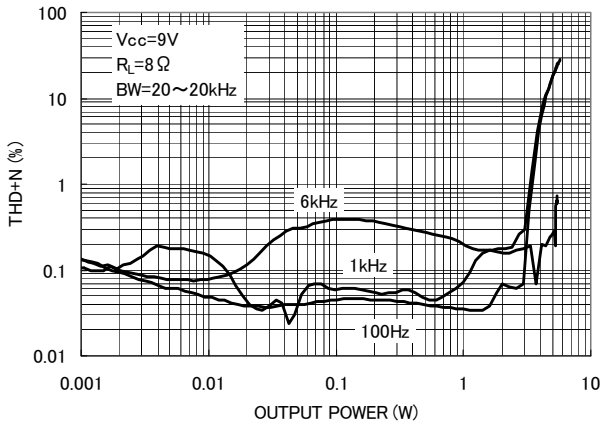

Fig. 1 THD+N - Output Power

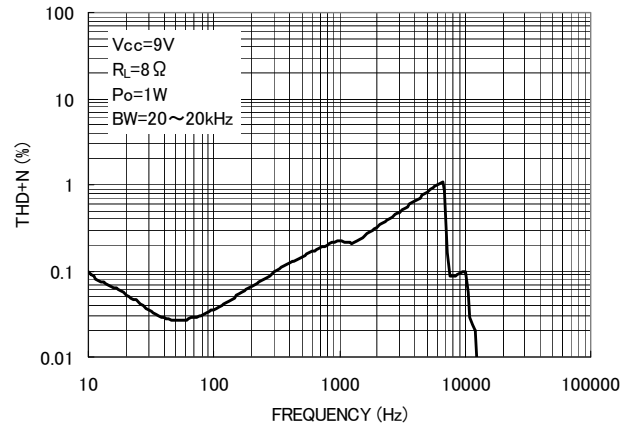

Fig. 2 THD+N - Frequency

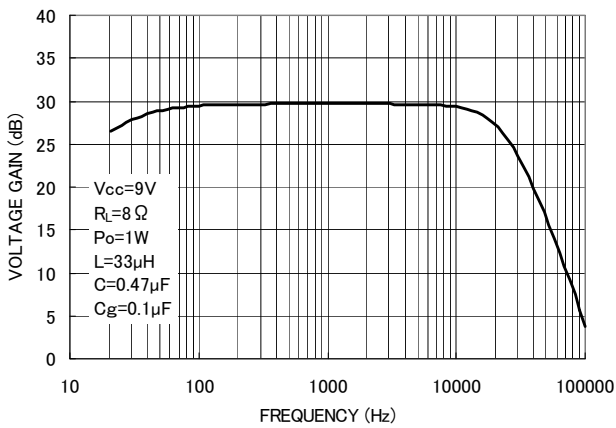

Fig. 3 Voltage Gain - Frequency

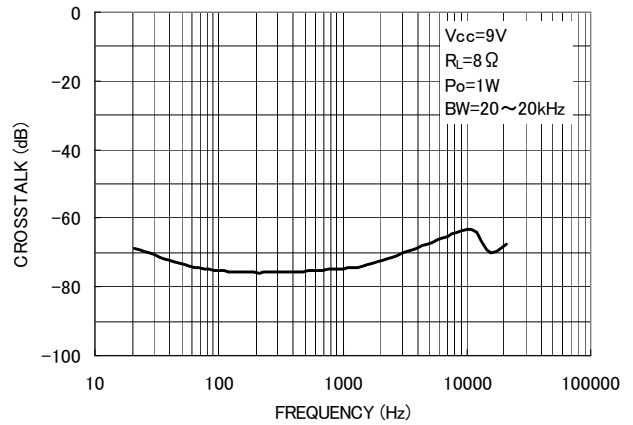

Fig. 4 Crosstalk - Frequency

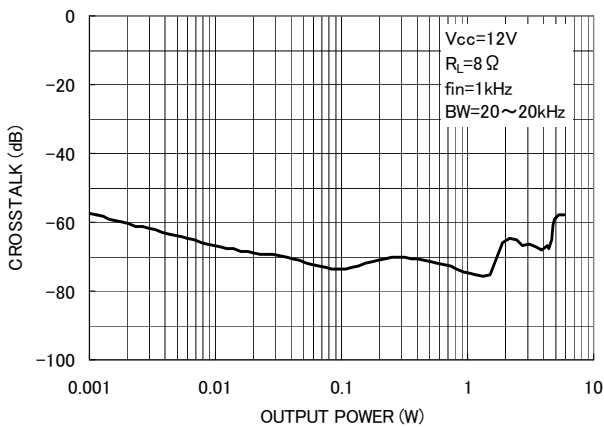

Fig. 5 Crosstalk - Output Power

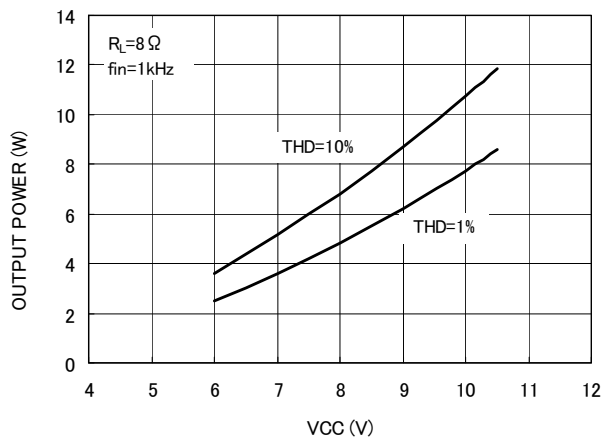

Fig. 6 Output Power - Supply Voltage

●Electrical characteristic curves (Reference data) – Continued

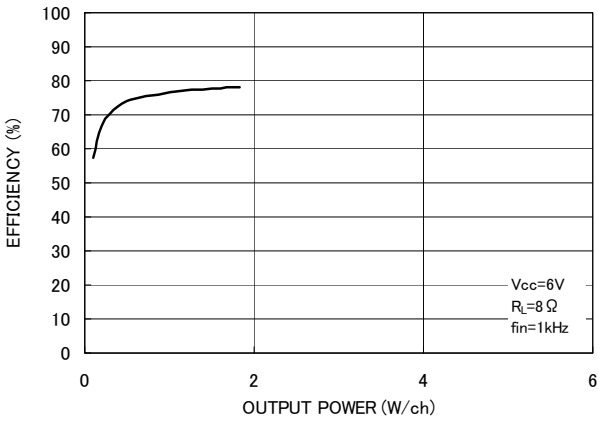

Fig. 7 Efficiency - Output Power

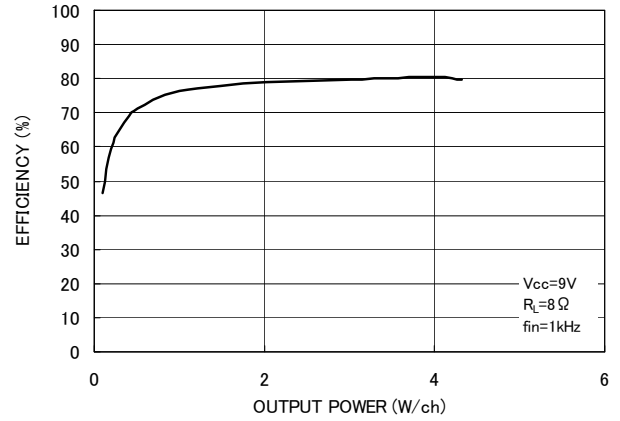

Fig. 8 Efficiency - Output Power

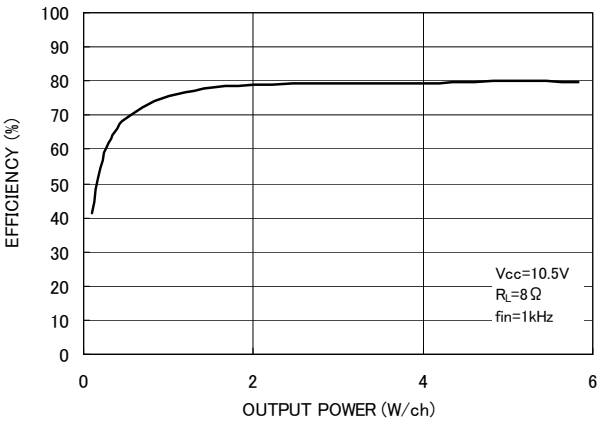

Fig. 9 Efficiency - Output Power

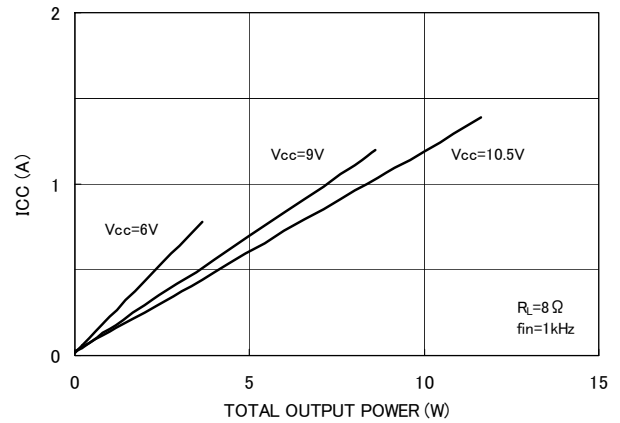

Fig. 10 Current Consumption - Output Power

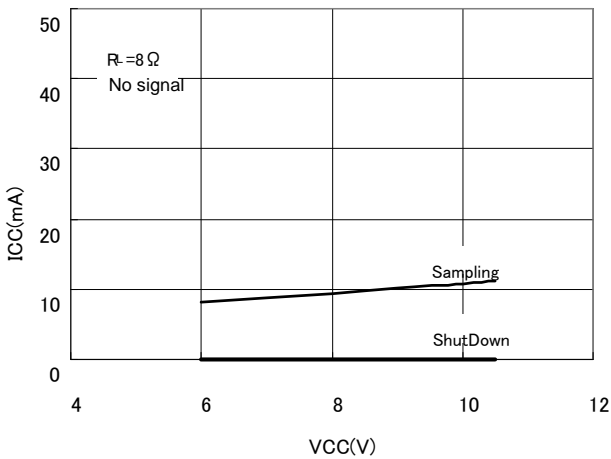

Fig. 11 50 Current Consumption - Supply Voltage

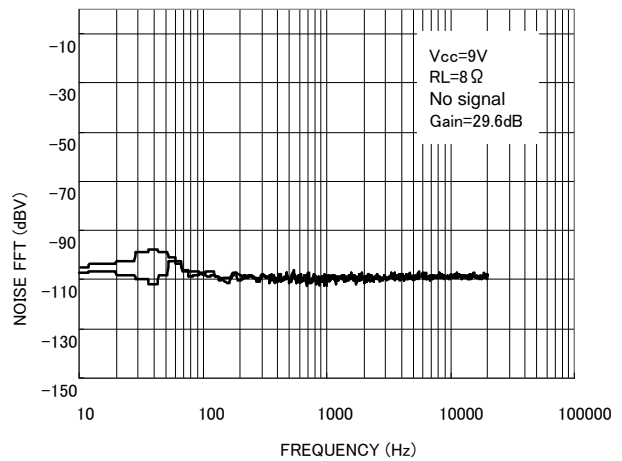

Fig. 12 Output Noise Voltage FFT

●Electrical characteristic curves (Reference data) – Continued

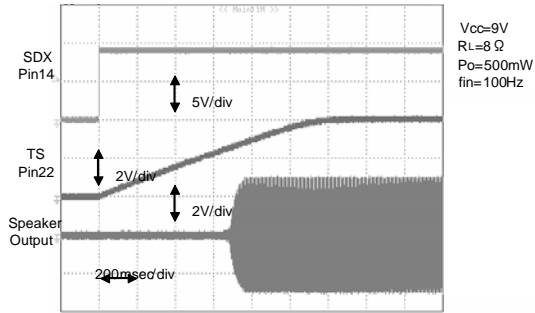

Fig. 13 Waveform at Soft Mute Reset

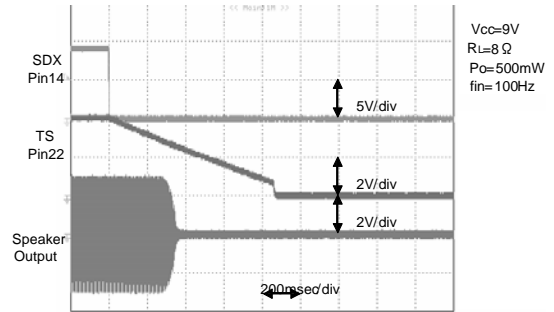

Fig. 14 Waveform at Soft Mute

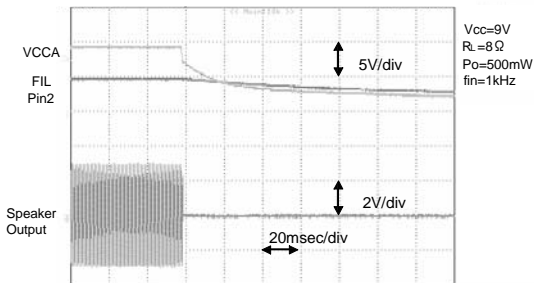

Fig. 15 Waveform at Instantaneous Power Interruption (20msec/div)

●Electrical characteristic curves (Reference data) – Continued

(2) Under Stereo Operation ($R_L=16\ \Omega$)

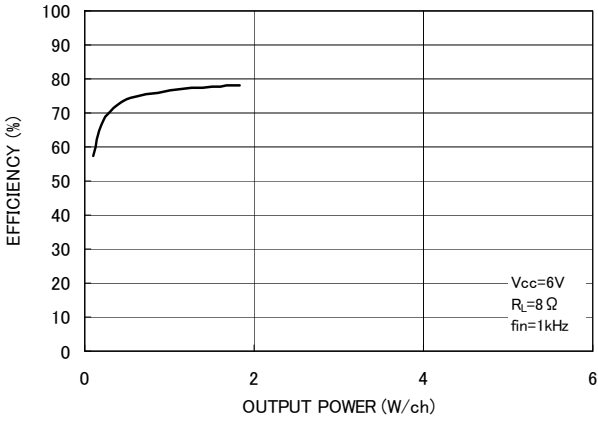

Fig. 16 Output Power - Supply Voltage

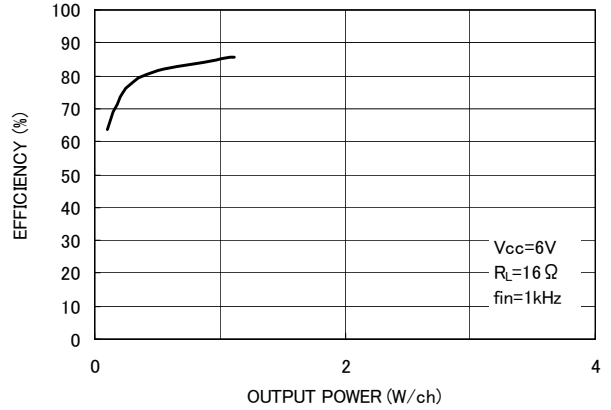

Fig. 17 Efficiency - Output Power

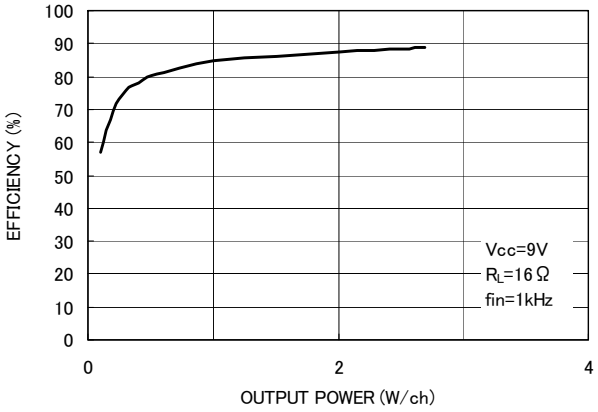

Fig. 18 Efficiency - Output Power

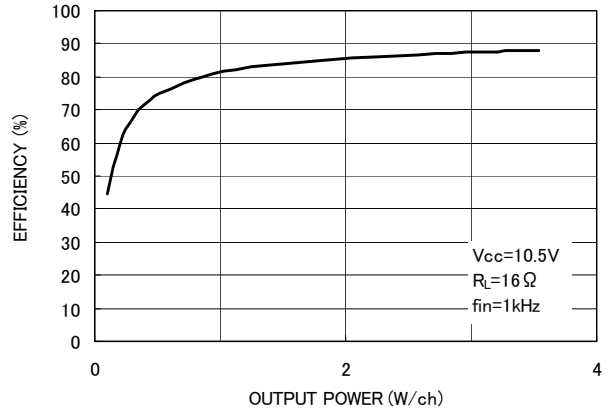

Fig. 19 Efficiency - Output Power

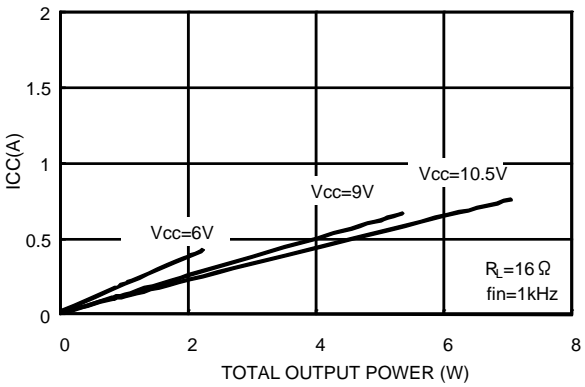

Fig. 20 Current Consumption - Output Power

●Electrical characteristic curves (Reference data) – Continued

(3) Under Stereo Operation ($R_L=6\Omega$)

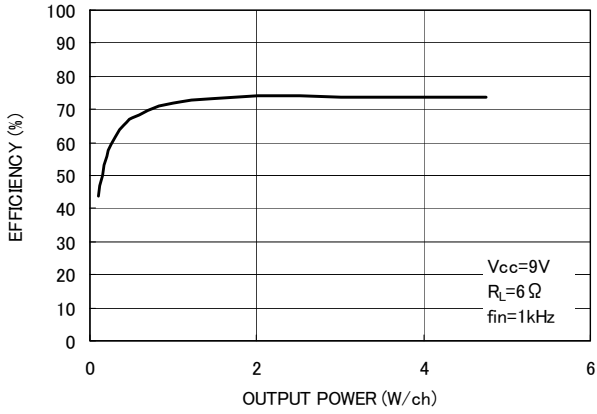

Fig. 21 Output Power - Supply Voltage

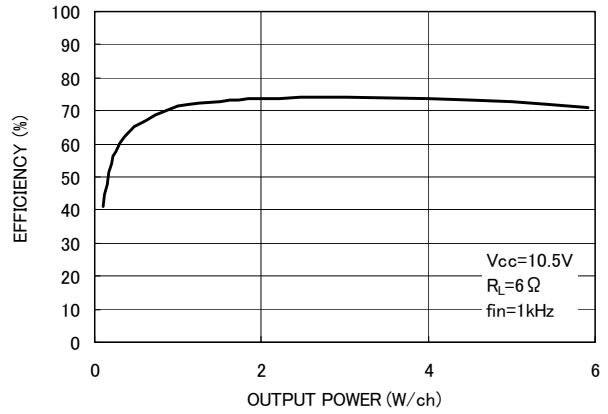

Fig. 22 Efficiency - Output Power

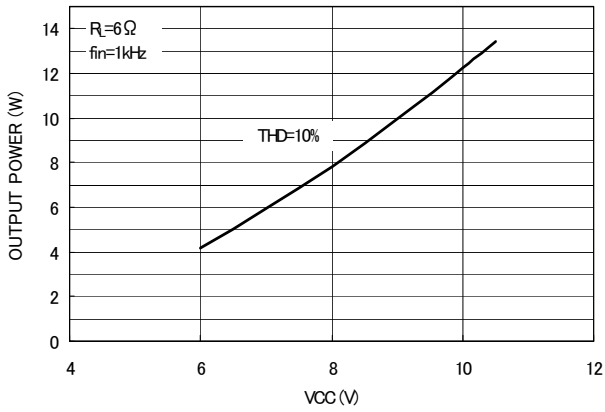

Fig. 23 Efficiency - Output Power

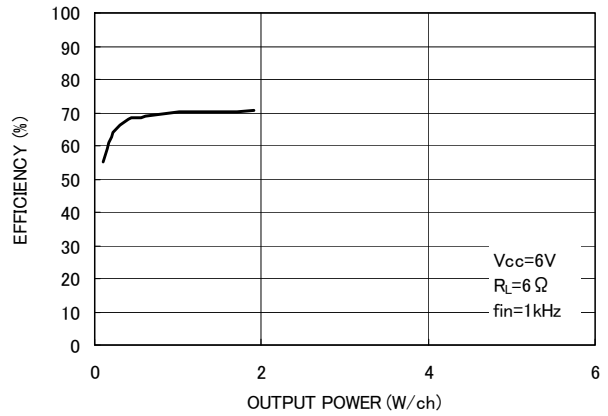

Fig. 24 Efficiency - Output Power

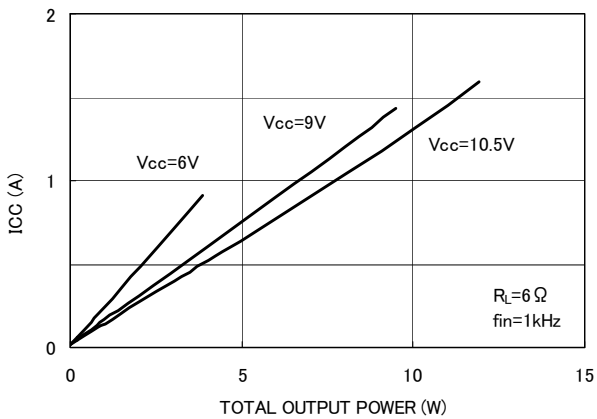
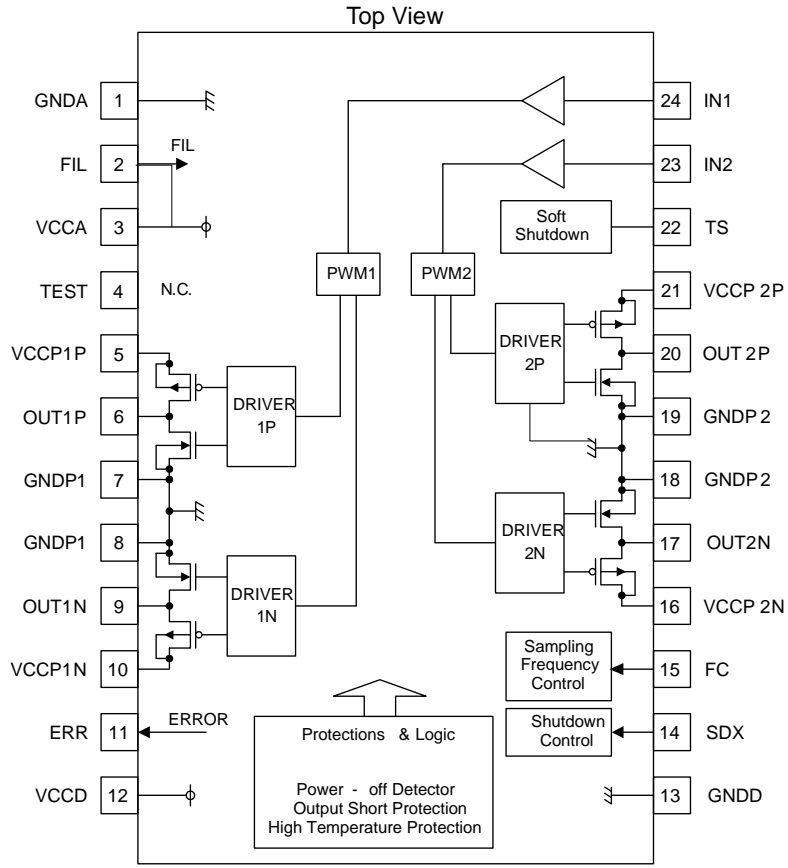

Fig. 25 Current Consumption - Output Power

● Pin Assignment Diagram



● Outer Dimensions and Inscriptions

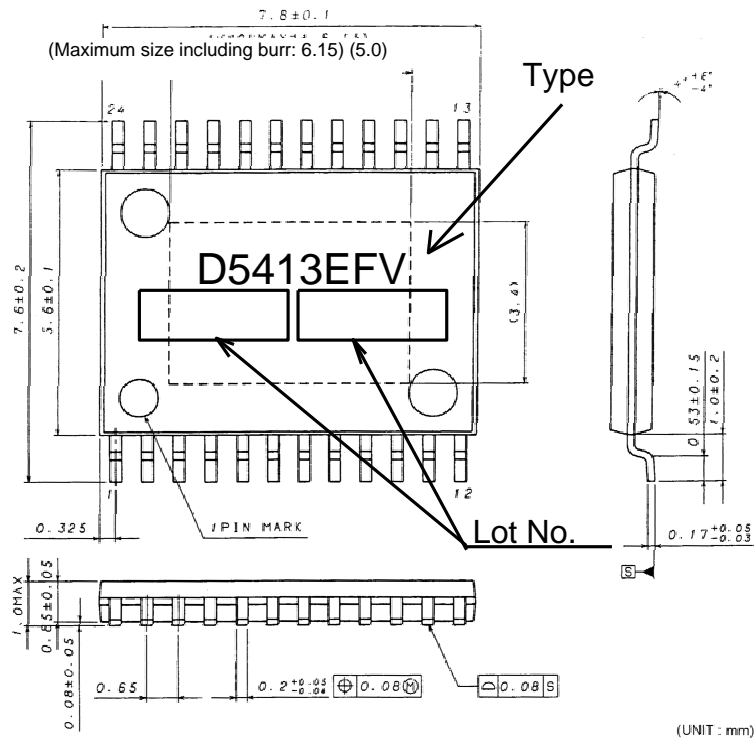
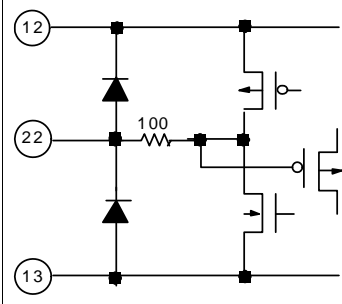
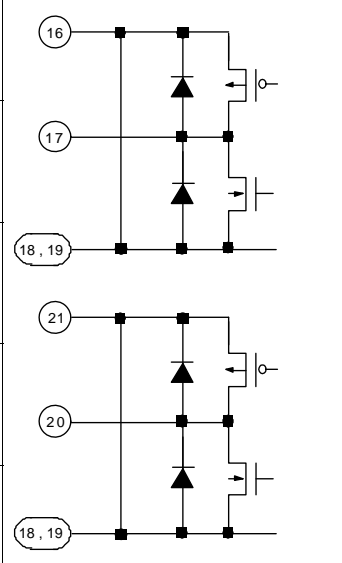
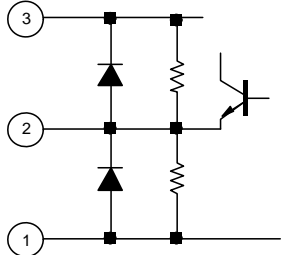

Fig. 27 Outer Dimensions and Inscriptions of the HTSSOP-B24 Package

●Pin configuration (Pin Voltage: Typical Value)

No.	Symbol	Pin voltage	Pin description	Internal equalizing circuit
24 23	IN1 IN2	1/2Vcc	ch1: Analog signal input pin ch2: Analog signal input pin Input an audio signal via a capacitor.	
5	VCCP1P	Vcc	ch1: Positive power system power supply pin	
6	OUT1P	Vcc to 0V	ch1: Positive PWM signal output pin Make connection to the output LPF.	
7, 8	GNDP1	0V	ch1: Power GND pin	
9	OUT1N	Vcc to 0V	ch1: Negative PWM signal output pin Make connection to the output LPF.	
10	VCCP1N	Vcc	ch1: Negative power system power supply pin	
11	ERROR	H: 5V L: 0V	Error output pin Pin for notifying an operation error H: Error L: Normal operation	
12	VCCD	Vcc	Control power supply pin	
13	GNDD	0V	Control GND pin	
14	SDX	-	Shut-down control pin H: Shut-down OFF L: Shut-down ON	

●Pin configuration - Continued

No.	Symbol	Pin voltage	Pin description	Internal equalizing circuit
4	TEST	Vcc	Do not use the TEST pin. Keep this pin open or connect it to VCC for regular use.	
22	TS	0 to 4V	Shut-down ON/OFF Constant setting pin Connect a capacitor.	
16	VCCP2N	Vcc	ch2: Negative power system power supply pin	
17	OUT2N	Vcc to 0V	ch2: Negative PWM signal output pin Make connection to the output LPF.	
18, 19	GNDP2	0V	ch2: Power GND pin	
20	OUT2P	Vcc to 0V	ch2: Positive PWM signal output pin Make connection to the output LPF.	
21	VCCP2P	Vcc	ch2: Positive power system power supply pin	
3	VCCA	Vcc	Analog system power supply pin	
2	FILA	1/2Vcc	Analog signal system bias pin Connect a capacitor.	
1	GND A	0V	Analog signal system GND pin	

●Application Circuit Diagram

- (1)Application Circuit Diagram with a Load of 8Ω for Stereo Operation
- Vcc=6V to 10.5V

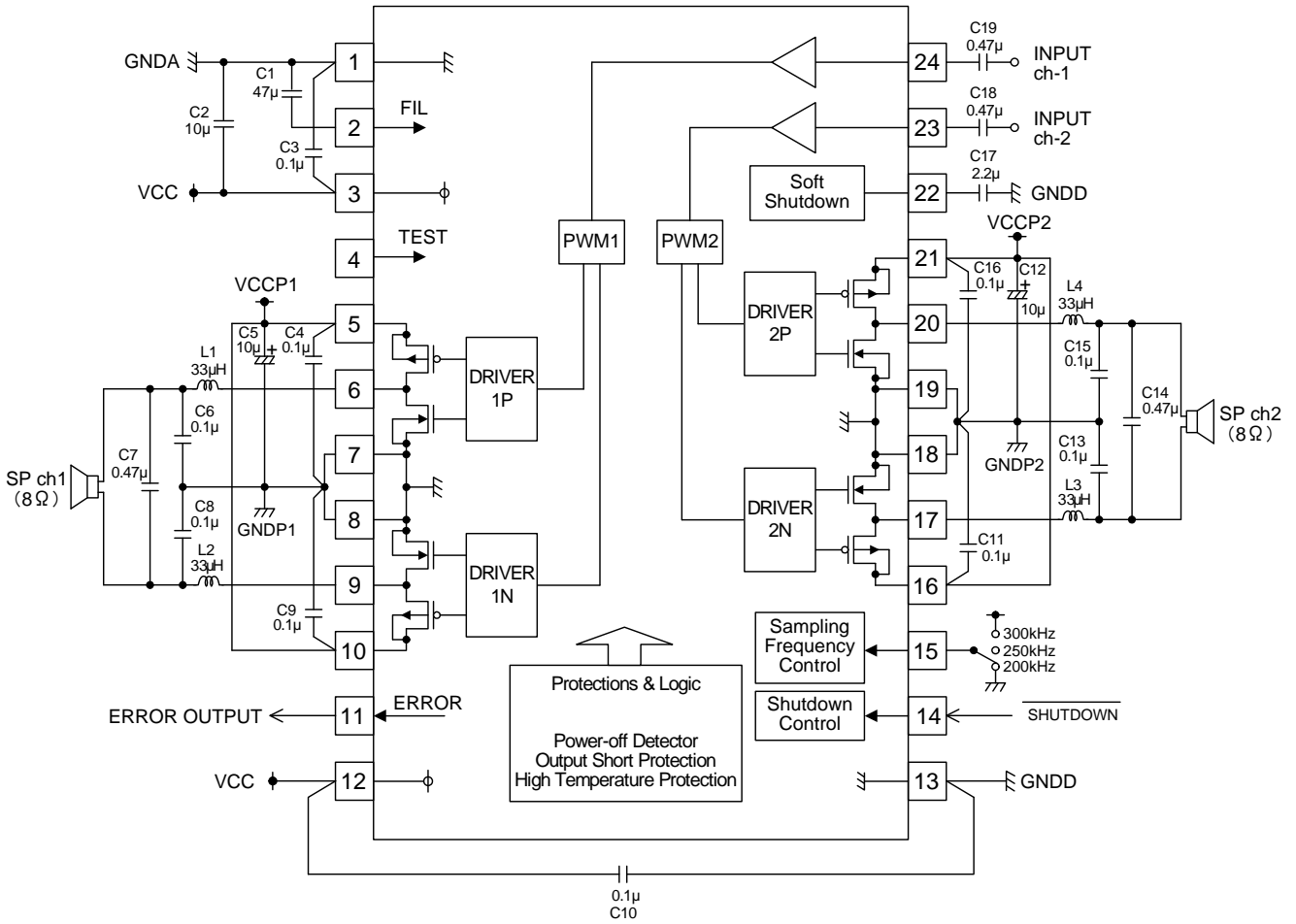

Fig.28 Circuit Diagram with a Load of 8Ω for Stereo Operation

(2)BOMs of Boards for Stereo Operation

Table 1 BOMs of Boards with Loads of 8Ω, 6Ω and 16Ω for Stereo Operation

No.	Item	Part Number	Vendor	Configuration		Value	Rated voltage	Tolerance	Temperature characteristics	Quantity	Reference
				mm	inch						
1	IC	BD5413EFV	ROHM	HTSSOP-B24		-	-	-	-	1	IC1
2	C	GRM32EB31A476KE20	MURATA	3225	1210	47μF	10V	±10%	±10%	1	C1
3	C	GRM21BB31C106KE15	MURATA	2012	0805	10μF	16V	±10%	±10%	1	C2
4	C	GRM188B11C104KA01	MURATA	1608	0603	0.1μF	16V	±10%	±10%	6	C3, C4, C9, C10, C11, C16
5	C	GRM188B30J225KE18	MURATA	1608	0603	2.2μF	6.3V	±10%	±10%	1	C17
6	C	GRM188B11C474KA87	MURATA	1608	0603	0.47μF	16V	±10%	±10%	2	C18, C19
7	C	EMZA350ADA100ME61G	CHEM1-00N	5.3×5.3		10μF	35V	±20%	+20%, -25%	2	C5, C12

BOM of Board with a Load Resistance of 8Ω

No.	Item	Part Number	Vendor	Configuration		Value	Rated voltage	Tolerance	Temperature characteristics	Quantity	Reference
				mm	inch						
8	C	GRM188B11C104KA01	MURATA	1608	0603	0.1μF	16V	±10%	±10%	4	C6, C8, C13, C15
9	C	GRM188B11C474KA87	MURATA	1608	0603	0.47μF	16V	±10%	±10%	2	C7, C14

No.	Item	Part Number	Vendor	Configuration		Value	Tolerance	DC Resistance	Rated DC Current	Quantity	Reference
				mm							
10	L	TSL0808RA-330K1R4-PF	TDK	Φ8.5, 8.3		33μH	±10%	92mΩmax	1.4A max	4	L1, L2, L3, L4

BOM of Board with a Load Resistance of 6Ω

No.	Item	Part Number	Vendor	Configuration		Value	Rated voltage	Tolerance	Temperature characteristics	Quantity	Reference
				mm	inch						
8	C	GRM188B11C474KA87	MURATA	1608	0603	0.47μF	16V	±10%	±10%	4	C6, C8, C13, C15
9	C	GRM188B11C474KA87	MURATA	1608	0603	0.47μF	16V	±10%	±10%	2	C7, C14

No.	Item	Part Number	Vendor	Configuration		Value	Tolerance	DC Resistance	Rated DC Current	Quantity	Reference
				mm							
10	L	TSL0808RA-220K1R7-PF	TDK	Φ8.5, 8.3		22μH	±10%	70mΩmax	1.7A max	4	L1, L2, L3, L4

BOM of Board with a Load Resistance of 16Ω

No.	Item	Part Number	Vendor	Configuration		Value	Rated voltage	Tolerance	Temperature characteristics	Quantity	Reference
				mm	inch						
8	C	GRM188B11C104KA01	MURATA	1608	0603	0.01μF	16V	±10%	±10%	4	C6, C8, C13, C15
9	C	GRM188B11C224KA01	MURATA	1608	0603	0.22μF	16V	±10%	±10%	2	C7, C14

No.	Item	Part Number	Vendor	Configuration		Value	Tolerance	DC Resistance	Rated DC Current	Quantity	Reference
				mm							
10	L	TSL0808RA-680K1R0-PF	TDK	Φ8.5, 8.3		68μH	±10%	160mΩmax	1A max	4	L1, L2, L3, L4

●Notes for use

1. About absolute maximum ratings

If an applied voltage or an operating temperature exceeds an absolute maximum rating, it may cause destruction of a device. A result of destruction, whether it is short mode or open mode, is not predictable. Therefore, provide a physical safety measure such as fuse, against a special mode that may violate conditions of absolute maximum ratings.

2. About power supply line

As return of current regenerated by back EMF of output coil happens, take steps such as putting capacitor between power supply and GND as a electric pathway for the regenerated current. Be sure that there is no problem with each property such as emptied capacity at lower temperature regarding electrolytic capacitor to decide capacity value. If the connected power supply does not have sufficient current absorption capacity, regenerative current will cause the voltage on the power supply line to rise, which combined with the product and its peripheral circuitry may exceed the absolute maximum ratings. It is recommended to implement a physical safety measure such as the insertion of a voltage clamp diode between the power supply and GND pins.

3. Potential of GND (1, 7, 8, 13, 18 and 19 pins)

Potential of the GND terminal must be the lowest under any operating conditions.

4. About thermal design

Perform thermal design with sufficient margins, in consideration of maximum power dissipation P_d under actual operating conditions. This product has an exposed frame on the back of the package, and it is assumed that the frame is used with measures to improve efficiency of heat dissipation. In addition to front surface of board, provide a heat dissipation pattern as widely as possible on the back also.

A class-D power amplifier has heat dissipation efficiency far higher than that of conventional analog power amplifier and generates less heat. However, extra attention must be paid in thermal design so that a power dissipation P_{diss} should not exceed the maximum power dissipation P_d .

$$\text{Maximum power dissipation} \quad P_d = P_o \frac{T_{jmax} - T_a}{\theta_{ja}} \quad [W]$$

$$\text{Power dissipation} \quad P_{diss} = P_o \left(\frac{1}{\eta} - 1 \right) \quad [W]$$

T_{jmax} : Maximum temperature junction = 150[°C]

T_a : Operating ambient temperature [°C]

θ_{ja} : Package thermal resistance [°C/W]

P_o : Output power [W]

η : Efficiency

5. About operations in strong electric field

Note that the device may malfunction in a strong electric field.

6. Thermal shutdown (TSD) circuit

This product is provided with a built-in thermal shutdown circuit. When the thermal shutdown circuit operates, the output transistors are placed under open status. The thermal shutdown circuit is primarily intended to shut down the IC avoiding thermal runaway under abnormal conditions with a chip temperature exceeding $T_{jmax} = 150^\circ\text{C}$, and is not intended to protect and secure an electrical appliance. Accordingly, do not use this circuit function to protect a customer's electrical appliance.

7. About shorting between pins and installation failure

Be careful about direction and displacement of an IC when installing it onto the board. Faulty installation may destroy the IC when the device is energized. In addition, a foreign matter getting in between IC pins, pins and power supply, and pins and GND may cause shorting and destruction of the IC.

8. About power-on or power-off sequence

Set the SDX pin (pin 14) to "L" level before initiating the power-on sequence. Similarly, set the SDX pin (pin 14) to "L" level before initiating the power-off sequence. If such a setting is made, pop reduction is achieved at power-on or power-off sequence. In addition, note that all power supply pins shall be made active or inactive at the same time.

9. About error output pin (pin 11)

When a high temperature protection function or VCC/GND shorting protection function is activated, an error flag is output via an error output pin. Because the error output pin is primarily intended to indicate the state of BD5413EFV and is available only to protect BD5413EFV, it cannot be used for any other purposes.

10. About TEST pin (pin 4)

Do not use the TEST pin. Keep this pin open or connect it to VCC for regular use.

● Ordering part number

B	D
---	---

Part No
BD.

5	4	1	3
---	---	---	---

Part No.
5413

E	F	V
---	---	---

Package
EFV:HTSSOP-B24

E	2
---	---

Packaging and forming specification
E2: Embossed tape and reel

HTSSOP-B24

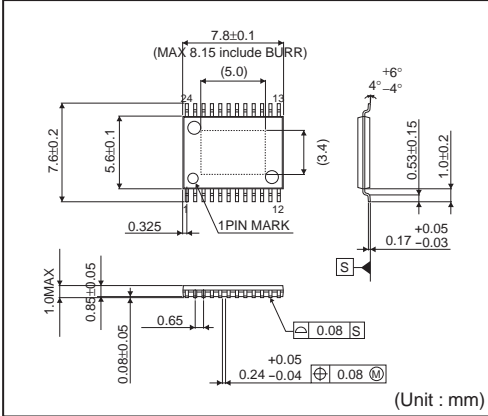

<Tape and Reel information>

Tape	Embossed carrier tape (with dry pack)
Quantity	2000pcs
Direction of feed	E2 (The direction is the 1pin of product is at the upper left when you hold reel on the left hand and you pull out the tape on the right hand)

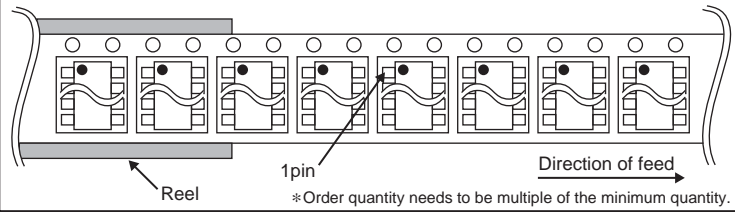

Notice

Precaution on using ROHM Products

- Our Products are designed and manufactured for application in ordinary electronic equipments (such as AV equipment, OA equipment, telecommunication equipment, home electronic appliances, amusement equipment, etc.). If you intend to use our Products in devices requiring extremely high reliability (such as medical equipment ^(Note 1), transport equipment, traffic equipment, aircraft/spacecraft, nuclear power controllers, fuel controllers, car equipment including car accessories, safety devices, etc.) and whose malfunction or failure may cause loss of human life, bodily injury or serious damage to property ("Specific Applications"), please consult with the ROHM sales representative in advance. Unless otherwise agreed in writing by ROHM in advance, ROHM shall not be in any way responsible or liable for any damages, expenses or losses incurred by you or third parties arising from the use of any ROHM's Products for Specific Applications.

(Note1) Medical Equipment Classification of the Specific Applications

JAPAN	USA	EU	CHINA
CLASS III	CLASS III	CLASS II b	CLASS III
CLASS IV		CLASS III	

- ROHM designs and manufactures its Products subject to strict quality control system. However, semiconductor products can fail or malfunction at a certain rate. Please be sure to implement, at your own responsibilities, adequate safety measures including but not limited to fail-safe design against the physical injury, damage to any property, which a failure or malfunction of our Products may cause. The following are examples of safety measures:
 - Installation of protection circuits or other protective devices to improve system safety
 - Installation of redundant circuits to reduce the impact of single or multiple circuit failure
- Our Products are designed and manufactured for use under standard conditions and not under any special or extraordinary environments or conditions, as exemplified below. Accordingly, ROHM shall not be in any way responsible or liable for any damages, expenses or losses arising from the use of any ROHM's Products under any special or extraordinary environments or conditions. If you intend to use our Products under any special or extraordinary environments or conditions (as exemplified below), your independent verification and confirmation of product performance, reliability, etc. prior to use, must be necessary:
 - Use of our Products in any types of liquid, including water, oils, chemicals, and organic solvents
 - Use of our Products outdoors or in places where the Products are exposed to direct sunlight or dust
 - Use of our Products in places where the Products are exposed to sea wind or corrosive gases, including Cl₂, H₂S, NH₃, SO₂, and NO₂
 - Use of our Products in places where the Products are exposed to static electricity or electromagnetic waves
 - Use of our Products in proximity to heat-producing components, plastic cords, or other flammable items
 - Sealing or coating our Products with resin or other coating materials
 - Use of our Products without cleaning residue of flux (even if you use no-clean type fluxes, cleaning residue of flux is recommended); or Washing our Products by using water or water-soluble cleaning agents for cleaning residue after soldering
 - Use of the Products in places subject to dew condensation
- The Products are not subject to radiation-proof design.
- Please verify and confirm characteristics of the final or mounted products in using the Products.
- In particular, if a transient load (a large amount of load applied in a short period of time, such as pulse. is applied, confirmation of performance characteristics after on-board mounting is strongly recommended. Avoid applying power exceeding normal rated power; exceeding the power rating under steady-state loading condition may negatively affect product performance and reliability.
- De-rate Power Dissipation (Pd) depending on Ambient temperature (Ta). When used in sealed area, confirm the actual ambient temperature.
- Confirm that operation temperature is within the specified range described in the product specification.
- ROHM shall not be in any way responsible or liable for failure induced under deviant condition from what is defined in this document.

Precaution for Mounting / Circuit board design

- When a highly active halogenous (chlorine, bromine, etc.) flux is used, the residue of flux may negatively affect product performance and reliability.
- In principle, the reflow soldering method must be used; if flow soldering method is preferred, please consult with the ROHM representative in advance.

For details, please refer to ROHM Mounting specification

Precautions Regarding Application Examples and External Circuits

1. If change is made to the constant of an external circuit, please allow a sufficient margin considering variations of the characteristics of the Products and external components, including transient characteristics, as well as static characteristics.
2. You agree that application notes, reference designs, and associated data and information contained in this document are presented only as guidance for Products use. Therefore, in case you use such information, you are solely responsible for it and you must exercise your own independent verification and judgment in the use of such information contained in this document. ROHM shall not be in any way responsible or liable for any damages, expenses or losses incurred by you or third parties arising from the use of such information.

Precaution for Electrostatic

This Product is electrostatic sensitive product, which may be damaged due to electrostatic discharge. Please take proper caution in your manufacturing process and storage so that voltage exceeding the Products maximum rating will not be applied to Products. Please take special care under dry condition (e.g. Grounding of human body / equipment / solder iron, isolation from charged objects, setting of ionizer, friction prevention and temperature / humidity control).

Precaution for Storage / Transportation

1. Product performance and soldered connections may deteriorate if the Products are stored in the places where:
 - [a] the Products are exposed to sea winds or corrosive gases, including Cl₂, H₂S, NH₃, SO₂, and NO₂
 - [b] the temperature or humidity exceeds those recommended by ROHM
 - [c] the Products are exposed to direct sunshine or condensation
 - [d] the Products are exposed to high Electrostatic
2. Even under ROHM recommended storage condition, solderability of products out of recommended storage time period may be degraded. It is strongly recommended to confirm solderability before using Products of which storage time is exceeding the recommended storage time period.
3. Store / transport cartons in the correct direction, which is indicated on a carton with a symbol. Otherwise bent leads may occur due to excessive stress applied when dropping of a carton.
4. Use Products within the specified time after opening a humidity barrier bag. Baking is required before using Products of which storage time is exceeding the recommended storage time period.

Precaution for Product Label

QR code printed on ROHM Products label is for ROHM's internal use only.

Precaution for Disposition

When disposing Products please dispose them properly using an authorized industry waste company.

Precaution for Foreign Exchange and Foreign Trade act

Since our Products might fall under controlled goods prescribed by the applicable foreign exchange and foreign trade act, please consult with ROHM representative in case of export.

Precaution Regarding Intellectual Property Rights

1. All information and data including but not limited to application example contained in this document is for reference only. ROHM does not warrant that foregoing information or data will not infringe any intellectual property rights or any other rights of any third party regarding such information or data. ROHM shall not be in any way responsible or liable for infringement of any intellectual property rights or other damages arising from use of such information or data.:
2. No license, expressly or implied, is granted hereby under any intellectual property rights or other rights of ROHM or any third parties with respect to the information contained in this document.

Other Precaution

1. This document may not be reprinted or reproduced, in whole or in part, without prior written consent of ROHM.
2. The Products may not be disassembled, converted, modified, reproduced or otherwise changed without prior written consent of ROHM.
3. In no event shall you use in any way whatsoever the Products and the related technical information contained in the Products or this document for any military purposes, including but not limited to, the development of mass-destruction weapons.
4. The proper names of companies or products described in this document are trademarks or registered trademarks of ROHM, its affiliated companies or third parties.

General Precaution

1. Before you use our Products, you are requested to carefully read this document and fully understand its contents. ROHM shall not be in any way responsible or liable for failure, malfunction or accident arising from the use of any ROHM's Products against warning, caution or note contained in this document.
2. All information contained in this document is current as of the issuing date and subject to change without any prior notice. Before purchasing or using ROHM's Products, please confirm the latest information with a ROHM sales representative.
3. The information contained in this document is provided on an "as is" basis and ROHM does not warrant that all information contained in this document is accurate and/or error-free. ROHM shall not be in any way responsible or liable for any damages, expenses or losses incurred by you or third parties resulting from inaccuracy or errors of or concerning such information.