

Gallery White LED Emitter

LZP-00GW00

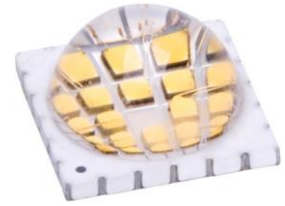

Key Features

- 24-die Gallery White (CRI 98) LED
- 3 SDCM color bins for CCT - 3000K
- Superior Color Rendering: CRI (Ra) 98; R9 98 and R15 98
- Up to 90 Watt power dissipation on compact 12.0mm x 12.0mm footprint
- Industry lowest thermal resistance per package size (0.6°C/W)
- Engineered ceramic package with integrated glass lens
- JEDEC Level 1 for Moisture Sensitivity Level
- Lead (Pb) free and RoHS compliant
- Reflow solderable (up to 6 cycles)
- Copper core MCPCB option with emitter thermal slug directly soldered to the copper core
- Full suite of TIR secondary optics family available

Typical Applications

- Gallery lighting
- Museum lighting
- High-end retail lighting
- Medical surgery lighting

Description

The LZP-00GW00 Gallery White features warm white light with an exceptional color rendering index (CRI) of 98, as well as impressive individual R values (R1-16) in industry's smallest footprint. It enables accurate color representation and enhances the contrast of retail merchandise, artwork and skin tones, which cannot be obtained with standard warm white LED emitters. The emitter, based on LED Engin's LuxiGen technology platform, may be driven up to 90W of power in a compact 12.0mmx12.0mm footprint. It has the industry lowest thermal resistance per package size, which allows users to drive the emitter with higher current, while keeping the junction temperature low to ensure long operating life.

Part number options

Base part number

Part number	Description
LZP-00GW00-xxxx	LZP Gallery White emitter
LZP-D0GW00-xxxx	LZP Gallery White emitter on 5 channel 4x6+1 Star MCPCB

Bin kit option codes

GW, Gallery White (CRI 98)			
Kit number suffix	Min flux Bin	Chromaticity bins	Description
0030	D2	3-step MacAdams ellipse	full distribution flux; 3000K ANSI CCT

Gallery White CCT Bins

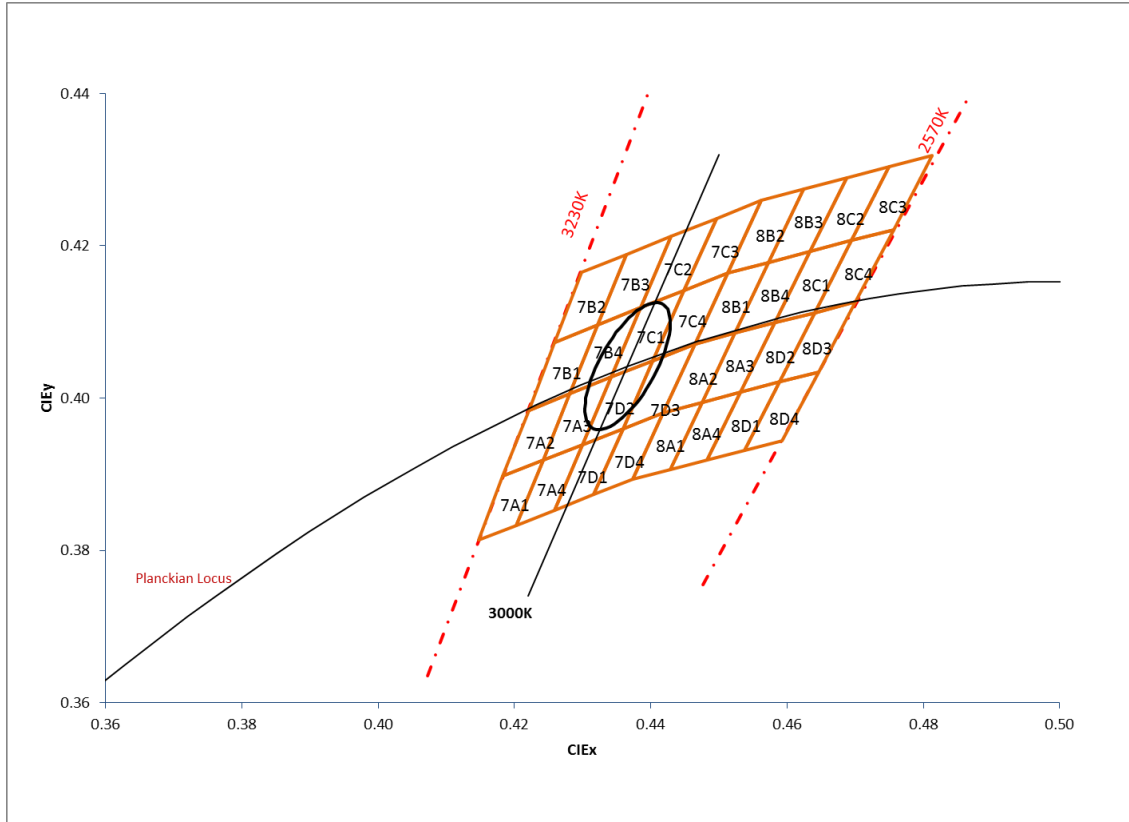

3-step MacAdam ellipse color bins plotted on excerpt from the CIE 1931 (2°) x-y Chromaticity Diagram. Coordinates are listed below in the table.

Gallery White 3-Step MacAdam Ellipse CCT Bin Coordinates

Nominal ANSI CCT	Center Point (cx, cy)	Major Axis a	Minor Axis b	Ellipse Rotation Angle (°)
3000	(0.4366, 0.4042)	0.00967	0.00399	56.6



Luminous Flux Bins

Table 1:

Bin Code	Minimum Luminous Flux (Φ_V) @ $I_F = 700\text{mA}$^[1,2] (lm)	Maximum Luminous Flux (Φ_V) @ $I_F = 700\text{mA}$^[1,2] (lm)
D2	2,350	2,600
E2	2,600	2,900
F2	2,900	3,200

Notes:

1. Luminous flux performance guaranteed within published operating conditions. LED Engin maintains a tolerance of $\pm 10\%$ on flux measurements.
2. Luminous Flux typical value is for all 24 LED dies operating at rated current. The LED is configured with 4 Channels of 6 dies in series.

Forward Voltage Bin

Table 2:

Bin Code	Minimum Forward Voltage (V_F) @ $I_F = 700\text{mA}$ /Channel^[1] (V)	Maximum Forward Voltage (V_F) @ $I_F = 700\text{mA}$ /Channel^[1] (V)
0	18.0 ^[2,3]	21.6 ^[2,3]

Notes:

1. LED Engin maintains a tolerance of $\pm 0.24\text{V}$ for forward voltage measurements.
2. All 4 white Channels have matched V_f for parallel operation
3. Forward Voltage is binned with 6 LED dies connected in series. The LED is configured with 4 Channels of 6 dies in series each.

Color Rendering Index Bin

Table 3:

Bin Code	Minimum Color Rendering Index @ $I_F = 700\text{mA}$
0	95.0

Absolute Maximum Ratings

Table 4:

Parameter	Symbol	Value	Unit
DC Forward Current at $T_{jmax}=135^{\circ}C$ ^[1]	I_F	1200	mA
DC Forward Current at $T_{jmax}=150^{\circ}C$ ^[1]	I_F	1000	mA
Peak Pulsed Forward Current ^[2]	I_{FP}	1500 /Channel	mA
Reverse Voltage	V_R	See Note 3	V
Storage Temperature	T_{stg}	-40 ~ +150	°C
Junction Temperature	T_J	150	°C
Soldering Temperature ^[4]	T_{sol}	260	°C
Allowable Reflow Cycles		6	
ESD Sensitivity ^[5]		> 8,000 V HBM Class 3B JESD22-A114-D	

Notes:

- Maximum DC forward current (per die) is determined by the overall thermal resistance and ambient temperature. Follow the curves in Figure 10 for current de-rating.
- Pulse forward current conditions: Pulse Width ≤ 10 msec and Duty cycle $\leq 10\%$.
- LEDs are not designed to be reverse biased.
- Solder conditions per JEDEC 020D. See Reflow Soldering Profile Figure 5.
- LED Engin recommends taking reasonable precautions towards possible ESD damages and handling the LZP-00GW00 in an electrostatic protected area (EPA). An EPA may be adequately protected by ESD controls as outlined in ANSI/ESD S6.1.

Optical Characteristics @ $T_C = 25^{\circ}C$

Table 5:

Parameter	Symbol	Typical	Unit
Luminous Flux (@ $I_F = 700mA$) ^[1]	Φ_V	2650	lm
Luminous Flux (@ $I_F = 1000mA$) ^[1]	Φ_V	3450	lm
Luminous Efficacy (@ $I_F = 350mA$)		63	lm/W
Correlated Color Temperature	CCT	3000	K
Color Rendering Index (CRI) ^[2]	R_a	98	
Viewing Angle ^[3]	$2\Theta_{1/2}$	110	Degrees

Notes:

- Luminous flux typical value is for all 24 LED dies operating at rated current.
- Typical R_a and individual R_1 through R_{16} values listed in Table 6
- Viewing Angle is the off-axis angle from emitter centerline where the luminous intensity is $\frac{1}{2}$ of the peak value.

Typical CRI (R_a) and individual R values

Table 6:

Ra	R1	R2	R3	R4	R5	R6	R7	R8	R9	R10	R11	R12	R13	R14	R15	R16
98	98	99	97	98	98	98	98	98	98	99	96	86	98	97	98	96

Electrical Characteristics @ T_C = 25°C

Table 7:

Parameter	Symbol	Typical	Unit
Forward Voltage (@ I _F = 700mA) ^[1]	V _F	19.4 /Channel	V
Forward Voltage (@ I _F = 1000mA) ^[1]	V _F	20.0 /Channel	V
Temperature Coefficient of Forward Voltage ^[1]	ΔV _F /ΔT _J	-12.0	mV/°C
Thermal Resistance (Junction to Case)	RΘ _{J-C}	0.6	°C/W

Notes:

1. Forward Voltage is measured for a single string of 6 dies connected in series. The LED is configured with 4 Channels of 6 dies in series each.

IPC/JEDEC Moisture Sensitivity Level

Table 8 - IPC/JEDEC J-STD-20D.1 MSL Classification:

Level	Soak Requirements					
	Floor Life		Standard		Accelerated	
	Time	Conditions	Time (hrs)	Conditions	Time (hrs)	Conditions
1	unlimited	≤ 30°C/ 85% RH	168 +5/-0	85°C/ 85% RH	n/a	n/a

Notes:

- The standard soak time includes a default value of 24 hours for semiconductor manufacturer's exposure time (MET) between bake and bag and includes the maximum time allowed out of the bag at the distributor's facility.

Average Lumen Maintenance Projections

Lumen maintenance generally describes the ability of a lamp to retain its output over time. The useful lifetime for solid state lighting devices (Power LEDs) is also defined as Lumen Maintenance, with the percentage of the original light output remaining at a defined time period. L70 defines the amount of operating hours at which the light output has reached 70% of its original output.

25 die (700mA & 1000mA, Rjc=0.6) L70 de-rating

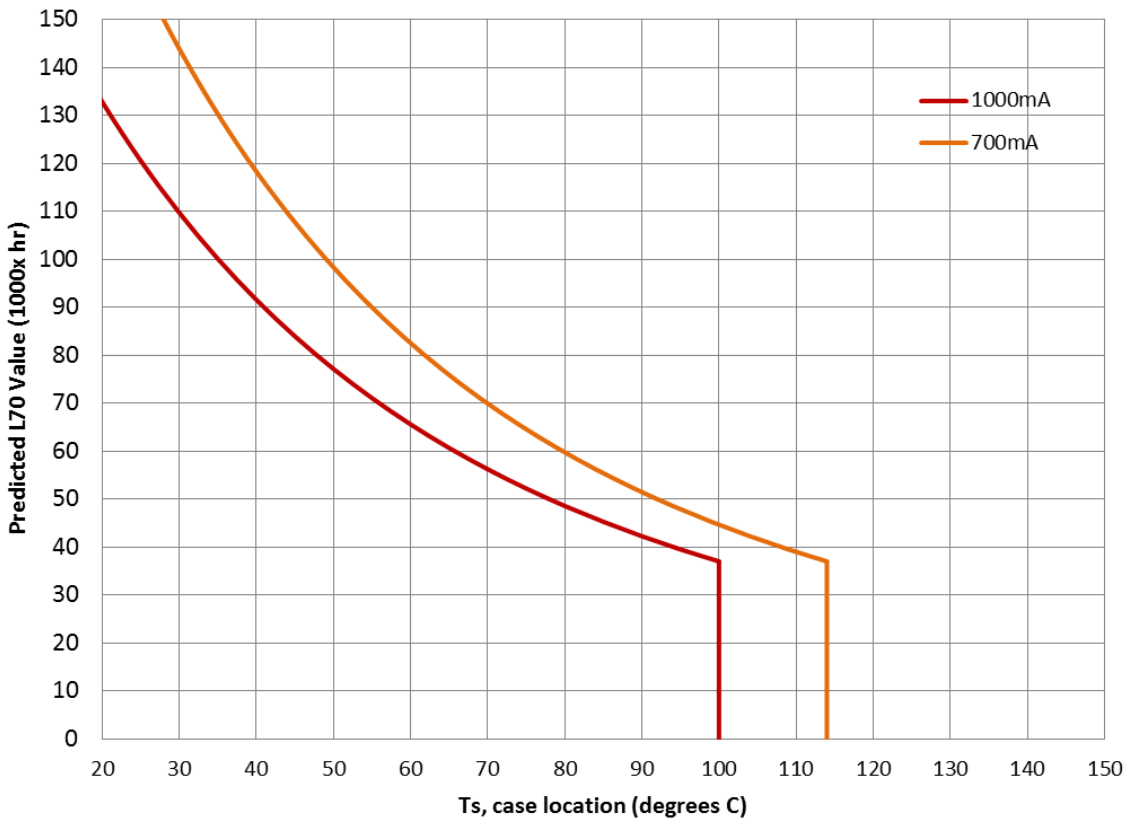

Figure 1: De-rating curve for operation of all dies at 700mA

Notes:

- See Figure 2 in Mechanical Dimensions section for exact Ts location.

Mechanical Dimensions (mm)

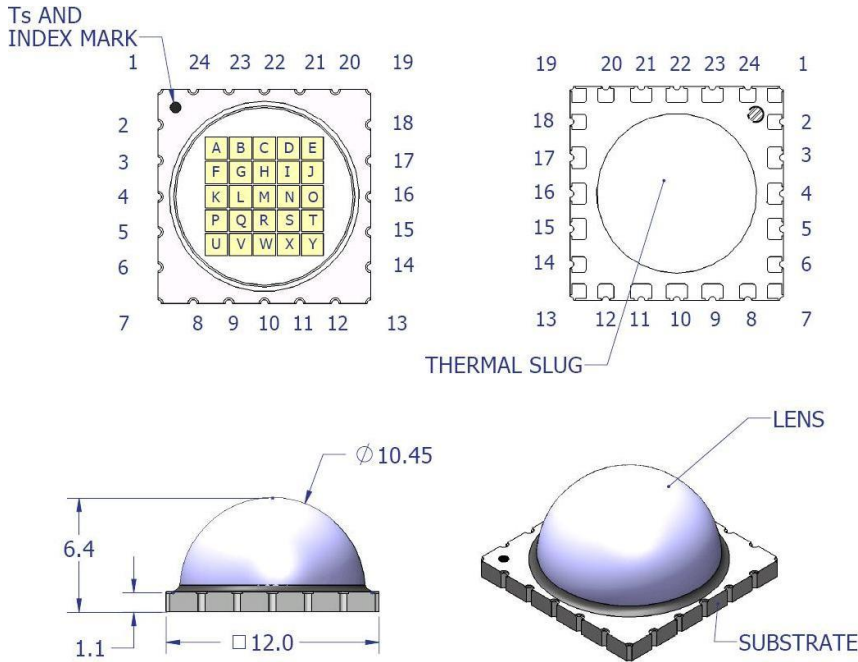

Figure 2: Package outline drawing.

Notes:

1. LZP-00GW00 pin out polarity is reversed; therefore it is not compatible with MCPCB designed for other LZP White emitters (i.e LZP-00xW00), except for LZP-00SW00.
2. Index mark, Ts indicates case temperature measurement point.
3. Unless otherwise noted, the tolerance = ± 0.20 mm.
4. Thermal slug is electrically isolated

Pin Out				
Ch.	Pad	Die	Color	Function
1	18	E	GW	Cathode
		D	GW	na
		C	GW	na
		B	GW	na
		A	GW	na
	24	F	GW	Anode
2	17	J	GW	Cathode
		I	GW	na
		H	GW	na
		G	GW	na
		L	GW	na
	3	K	GW	Anode
3	15	O	GW	Cathode
		N	GW	na
		S	GW	na
		R	GW	na
		Q	GW	na
	5	P	GW	Anode
4	14	T	GW	Cathode
		Y	GW	na
		X	GW	na
		W	GW	na
		V	GW	na
	8	U	GW	Anode
5	2	M	-	na
	23	M	-	na

Recommended Solder Pad Layout (mm)

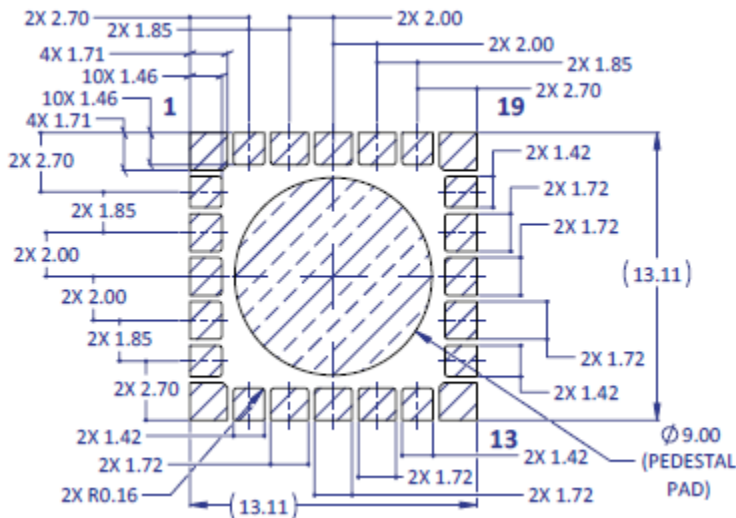
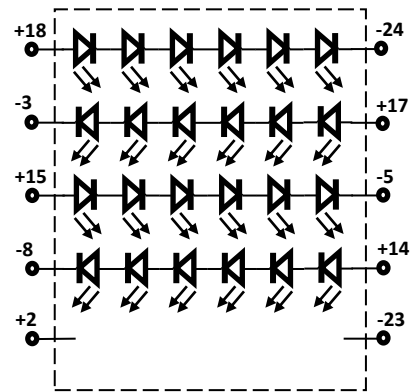

Figure 2a: Recommended solder pad layout for anode, cathode, and thermal pad

Notes:

1. Unless otherwise noted, the tolerance = ± 0.20 mm.
2. LED Engin recommends the use of copper core MCPCB's which allow for the emitter thermal slug to be soldered directly to the copper core (so called pedestal design). Such MCPCB technologies eliminate the high thermal resistance dielectric layer that standard MCPCB technologies use in between the emitter thermal slug and the metal core of the MCPCB, thus lowering the overall system thermal resistance.
3. LED Engin recommends x-ray sample monitoring for solder voids underneath the emitter thermal slug. The total area covered by solder voids should be less than 20% of the total emitter thermal slug area. Excessive solder voids will increase the emitter to MCPCB thermal resistance and may lead to higher failure rates due to thermal over stress.



Reflow Soldering Profile

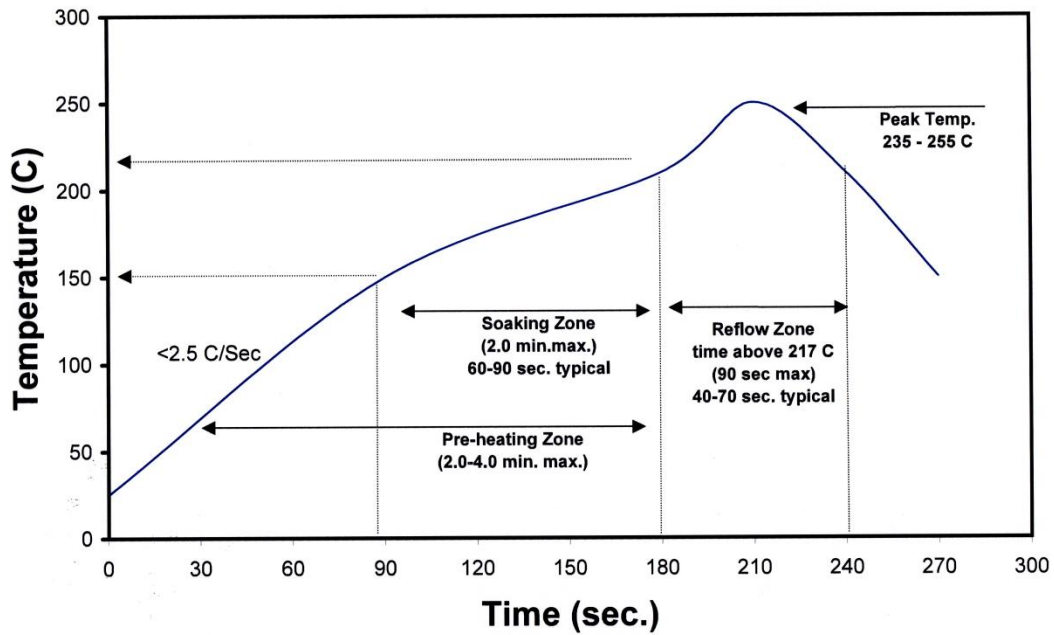

Figure 4: Reflow soldering profile for lead free soldering.

Typical Radiation Pattern

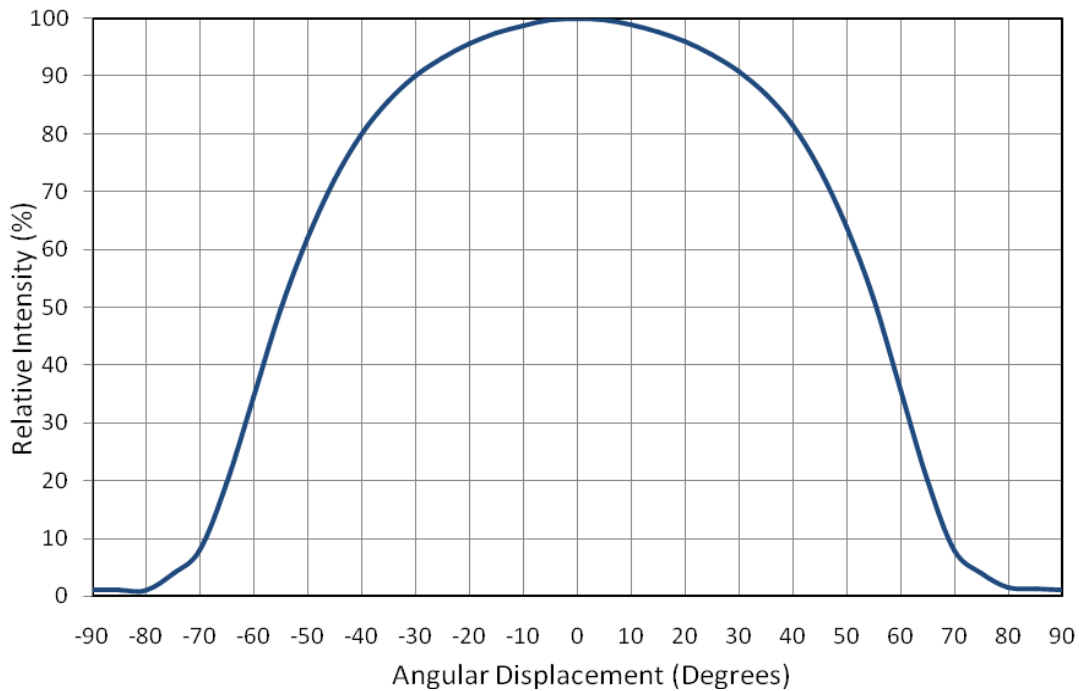

Figure 5: Typical representative spatial radiation pattern.

Typical Relative Spectral Power Distribution

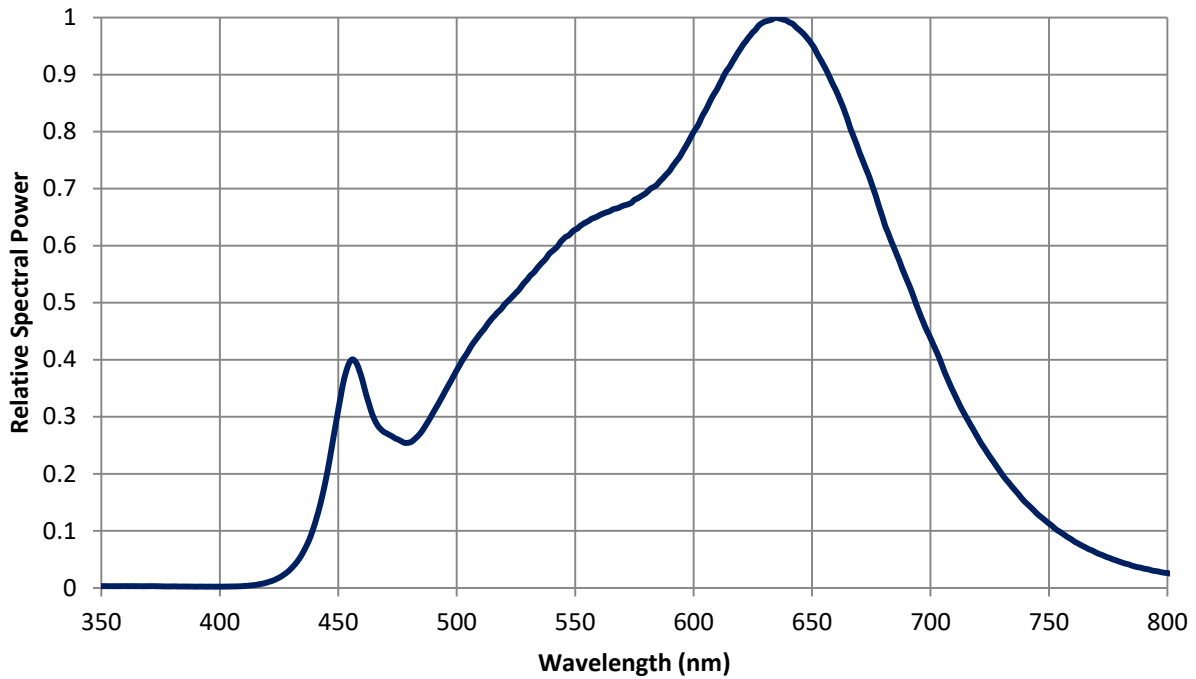

Figure 6: Typical relative spectral power vs. wavelength @ T_c = 25°C.

Typical Relative Light Output over Forward Current

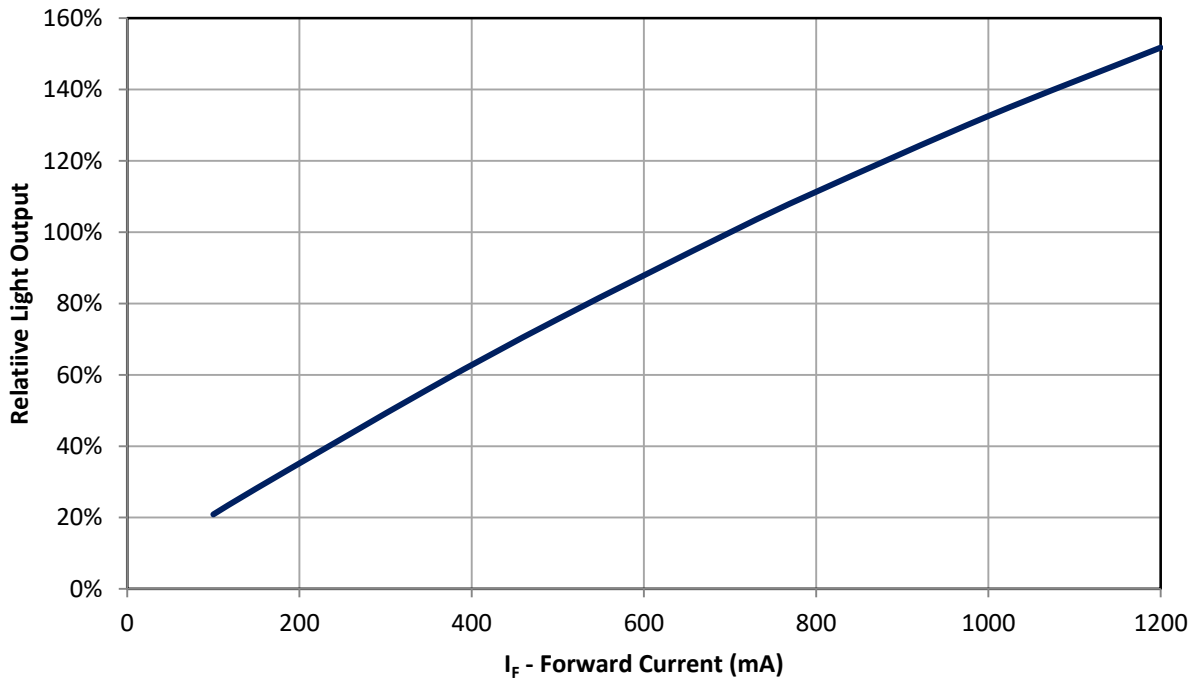

Figure 7: Typical relative light output vs. forward current @ T_c = 25°C.

Notes:

1. Luminous Flux typical value is for all 24 LED dies operating concurrently at rated current pro Channel.

Typical Relative Light Output over Temperature

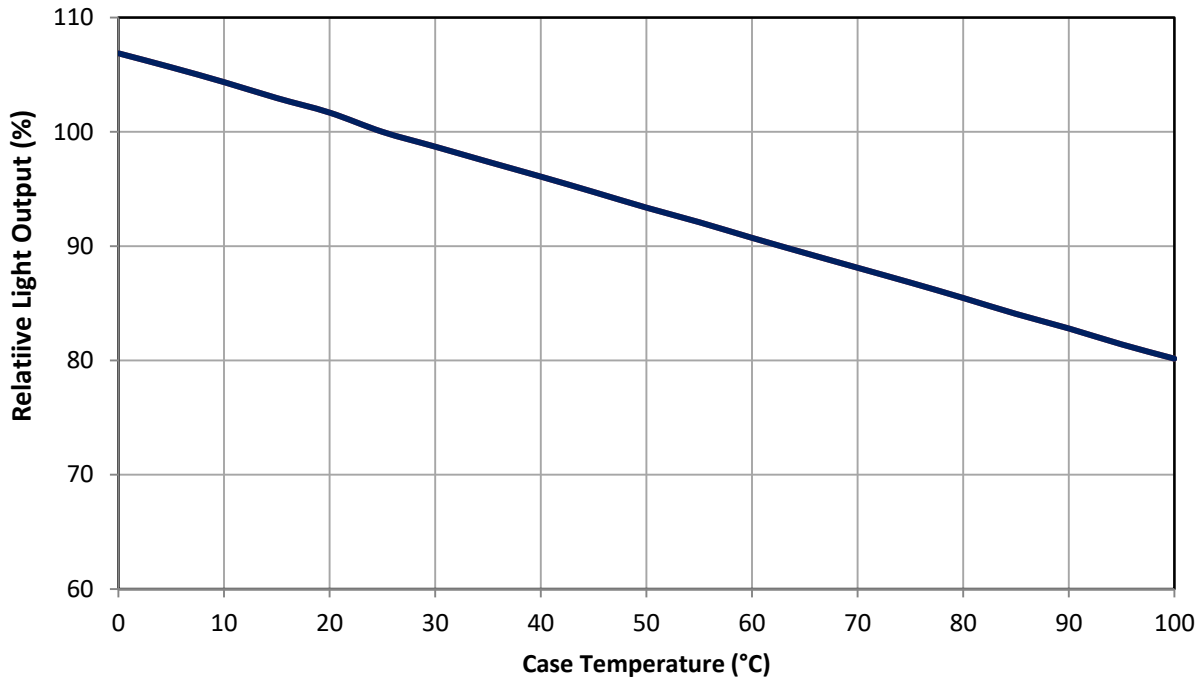

Figure 8: Typical relative light output vs. case temperature.

Notes:

1. Luminous Flux typical value is for all 24 LED dies operating concurrently at rated current pro Channel.

Typical Chromaticity Coordinate Shift over Forward Current

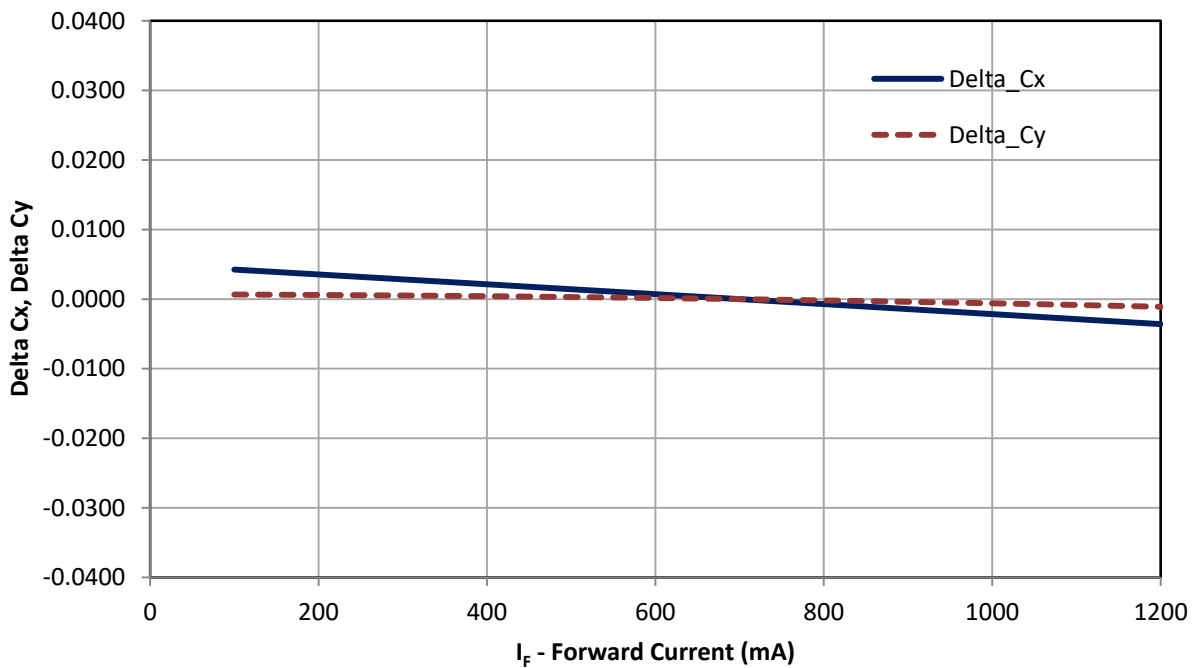

Figure 9: Typical chromaticity coordinate shift vs. forward current

Typical Chromaticity Coordinate Shift over Temperature

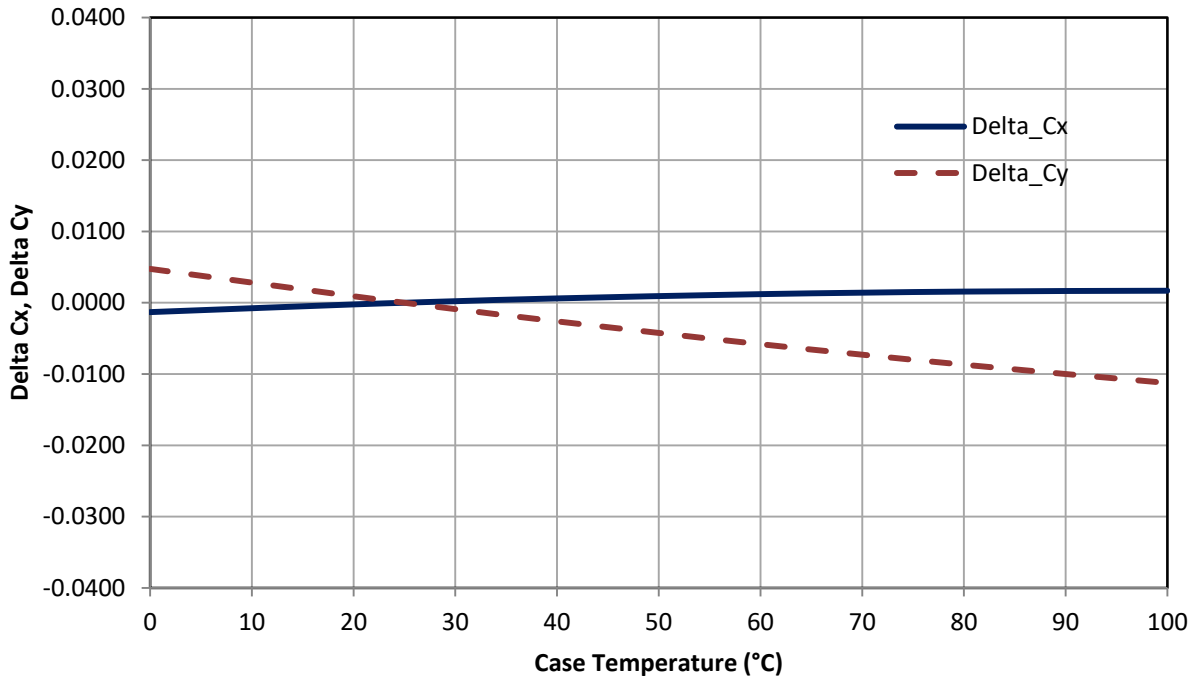

Figure 10: Typical chromaticity coordinate shift vs. Case temperature

Typical Forward Current Characteristics

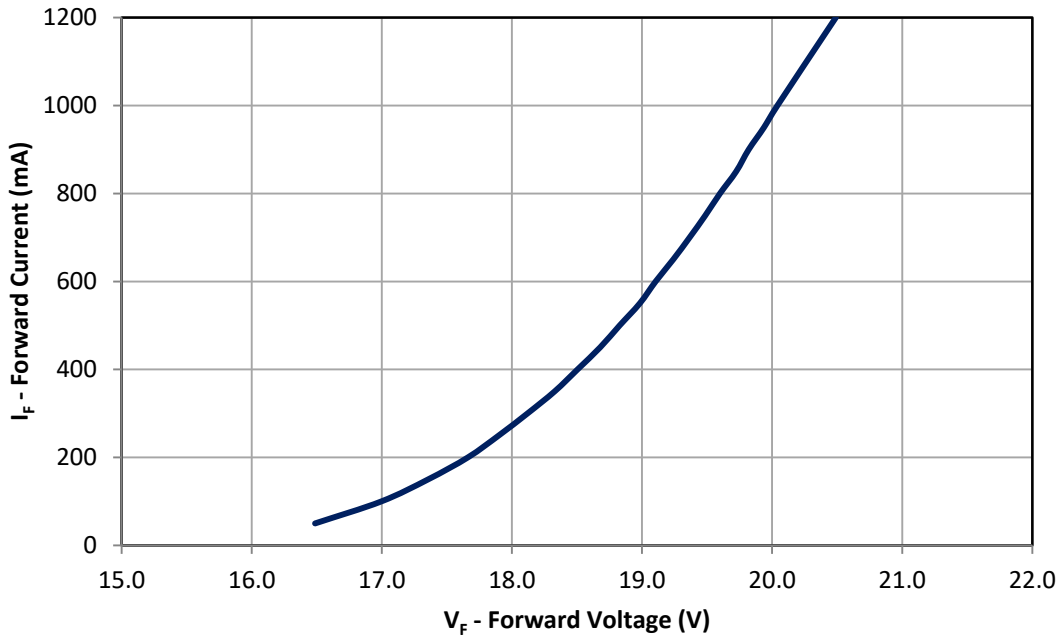

Figure 11: Typical forward current vs. forward voltage @ T_c = at 25°C.

Note:

1. Forward Voltage is measured for a single string of 6 dies connected in series. The LED is configured with 4 Channels of 6 dies in series each.

Current De-rating

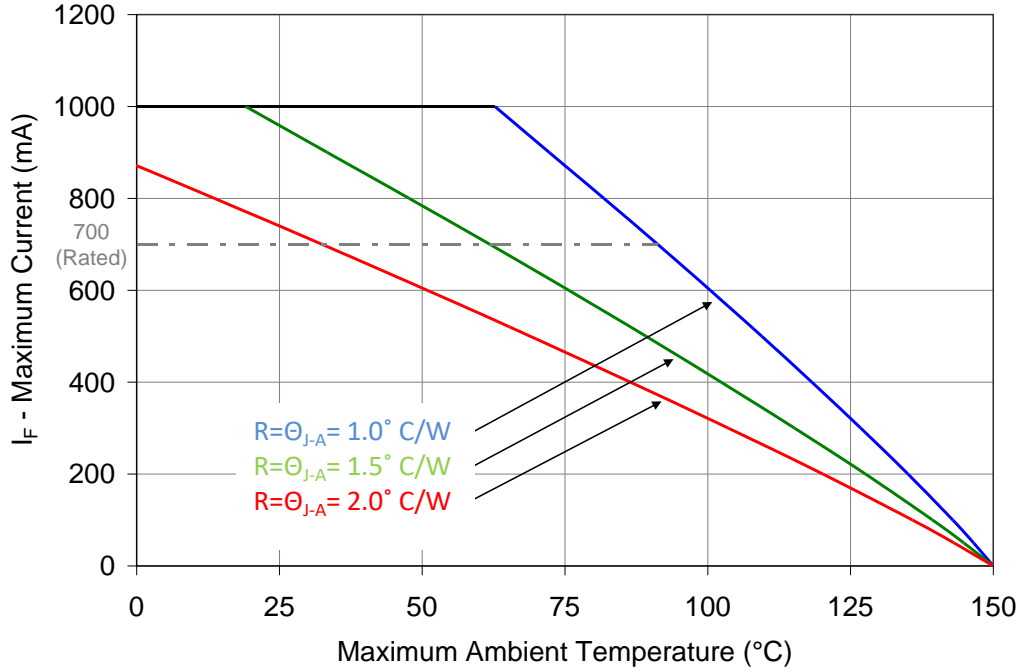

Figure 12: Maximum forward current vs. ambient temperature based on $T_{J(MAX)} = 150^{\circ}C$.

Notes:

1. Maximum current assumes that all LED dies are operating at rated current.
2. RO_{J-C} [Junction to Case Thermal Resistance] for the LZP-series is typically $0.6^{\circ}C/W$.
3. RO_{J-A} [Junction to Ambient Thermal Resistance] = RO_{J-C} + RO_{C-A} [Case to Ambient Thermal Resistance].

LZP MCPCB Family

Part number	Type of MCPCB	Diameter (mm)	Emitter + MCPCB Thermal Resistance (°C/W)	Typical V _f (V)	Typical I _f (mA)
LZP-DOGW00	5-channel (4x6+1 strings)	28.3	0.6 + 0.1 = 0.7	19.4	4 x 700

LZP-DOGW00

5-channel, Standard Star MCPCB (4x6+1) Mechanical Dimensions (mm)

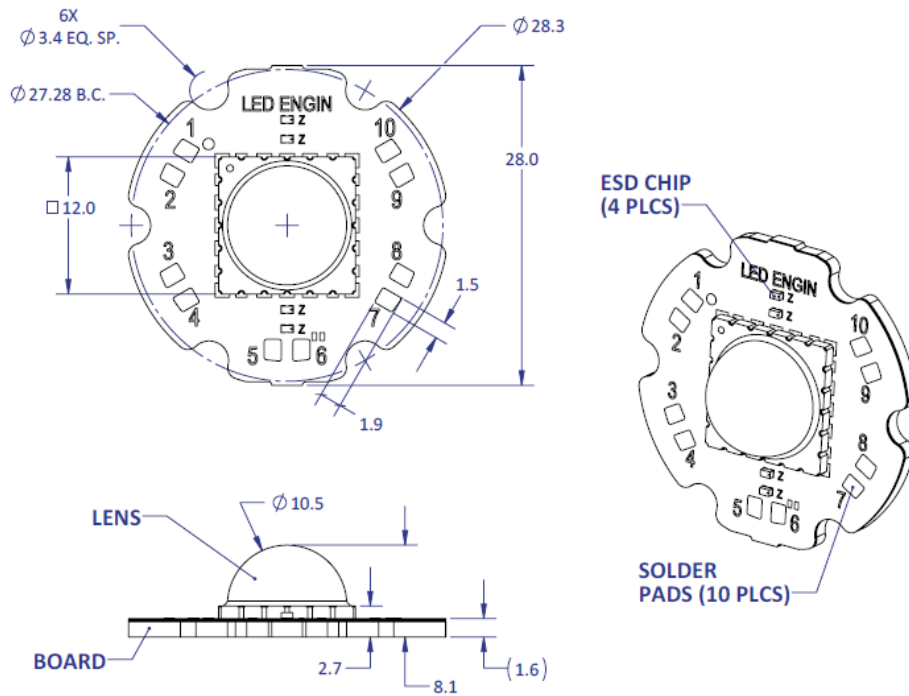

Notes:

- Unless otherwise noted, the tolerance = ± 0.20 mm.
- Slots in MCPCB are for M3 or #4 mounting screws.
- LED Engin recommends using plastic washers to electrically insulate screws from solder pads and electrical traces.
- LED Engin recommends using thermal interface material when attaching the MCPCB to a heat sink.
- LED Engin uses a copper core MCPCB with pedestal design, allowing direct solder connect between the MCPCB copper core and the emitter thermal slug. The thermal resistance of this copper core MCPCB is: $\theta_{JC-B} 0.1^{\circ}\text{C}/\text{W}$

Components used

MCPCB: SuperMCPCB (Bridge Semiconductor, copper core with pedestal design)
 ESD chips: BZT52C36LP (NXP, for 6 LED dies in series)

Pad layout			
Ch.	MCPCB Pad	String/die	Function
1	1	1/EDCBAF	Anode +
	10		Cathode -
2	2	2/JIHGLK	Anode +
	9		Cathode -
3	3	3/ONSRQP	Anode +
	8		Cathode -
4	4	4/TYXWVU	Anode +
	7		Cathode -
5	5	5/M	N/A
	6		N/A

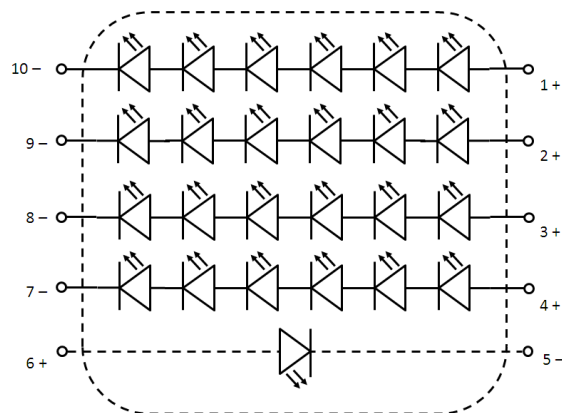

Application Guidelines

MCPCB Assembly Recommendations

A good thermal design requires an efficient heat transfer from the MCPCB to the heat sink. In order to minimize air gaps in between the MCPCB and the heat sink, it is common practice to use thermal interface materials such as thermal pastes, thermal pads, phase change materials and thermal epoxies. Each material has its pros and cons depending on the design. Thermal interface materials are most efficient when the mating surfaces of the MCPCB and the heat sink are flat and smooth. Rough and uneven surfaces may cause gaps with higher thermal resistances, increasing the overall thermal resistance of this interface. It is critical that the thermal resistance of the interface is low, allowing for an efficient heat transfer to the heat sink and keeping MCPCB temperatures low.

When optimizing the thermal performance, attention must also be paid to the amount of stress that is applied on the MCPCB. Too much stress can cause the ceramic emitter to crack. To relax some of the stress, it is advisable to use plastic washers between the screw head and the MCPCB and to follow the torque range listed below. For applications where the heat sink temperature can be above 50°C, it is recommended to use high temperature and rigid plastic washers, such as polycarbonate or glass-filled nylon.

LED Engin recommends the use of the following thermal interface materials:

1. Bergquist's Gap Pad 5000S35, 0.020in thick
 - Part Number: Gap Pad® 5000S35 0.020in/0.508mm
 - Thickness: 0.020in/0.508mm
 - Thermal conductivity: 5 W/m-K
 - Continuous use max temperature: 200°C
 - Using M3 Screw (or #4 screw), with polycarbonate or glass-filled nylon washer (#4) the recommended torque range is: 20 to 25 oz-in (1.25 to 1.56 lbf-in or 0.14 to 0.18 N-m)

2. 3M's Acrylic Interface Pad 5590H
 - Part number: 5590H @ 0.5mm
 - Thickness: 0.020in/0.508mm
 - Thermal conductivity: 3 W/m-K
 - Continuous use max temperature: 100°C
 - Using M3 Screw (or #4 screw), with polycarbonate or glass-filled nylon washer (#4) the recommended torque range is: 20 to 25 oz-in (1.25 to 1.56 lbf-in or 0.14 to 0.18 N-m)

Mechanical Mounting Considerations

The mounting of MCPCB assembly is a critical process step. Excessive mechanical stress build up in the MCPCB can cause the MCPCB to warp which can lead to emitter substrate cracking and subsequent cracking of the LED dies

LED Engin recommends the following steps to avoid mechanical stress build up in the MCPCB:

- Inspect MCPCB and heat sink for flatness and smoothness.
- Select appropriate torque for mounting screws. Screw torque depends on the MCPCB mounting method (thermal interface materials, screws, and washer).
- Always use three M3 or #4-40 screws with #4 washers.
- When fastening the three screws, it is recommended to tighten the screws in multiple small steps. This method avoids building stress by tilting the MCPCB when one screw is tightened in a single step.
- Always use plastic washers in combinations with the three screws. This avoids high point contact stress on the screw head to MCPCB interface, in case the screw is not seated perpendicular.
- In designs with non-tapped holes using self-tapping screws, it is common practice to follow a method of three turns tapping a hole clockwise, followed by half a turn anti-clockwise, until the appropriate torque is reached.

Wire Soldering

- To ease soldering wire to MCPCB process, it is advised to preheat the MCPCB on a hot plate of 125-150°C. Subsequently, apply the solder and additional heat from the solder iron will initiate a good solder reflow. It is recommended to use a solder iron of more than 60W.
- It is advised to use lead-free, no-clean solder. For example: SN-96.5 AG-3.0 CU 0.5 #58/275 from Kester (pn: 24-7068-7601)

About LED Engin

LED Engin, an OSRAM business based in California's Silicon Valley, develops, manufactures, and sells advanced LED emitters, optics and light engines to create uncompromised lighting experiences for a wide range of entertainment, architectural, general lighting and specialty applications. LuxiGen™ multi-die emitter and secondary lens combinations reliably deliver industry-leading flux density, upwards of 5000 quality lumens to a target, in a wide spectrum of colors including whites, tunable whites, multi-color and UV LEDs in a unique patented compact ceramic package. Our LuxiTune™ series of tunable white lighting modules leverage our LuxiGen emitters and lenses to deliver quality, control, freedom and high density tunable white light solutions for a broad range of new recessed and downlighting applications. The small size, yet remarkably powerful beam output and superior in-source color mixing, allows for a previously unobtainable freedom of design wherever high-flux density, directional light is required. LED Engin is committed to providing products that conserve natural resources and reduce greenhouse emissions; and reserves the right to make changes to improve performance without notice.

For more information, please contact LEDE-Sales@osram.com or +1 408 922-7200.