

SPECIFICATION

Part No. : **PC240.09.0300K**

Product Name : Embedded T-Bar 433MHz
Adhesive/Screw Mounted Helical Dipole
with 0.3M RG316 MMCX(M)RA

Features :

- Omni-Directional
- 96mm x 40mm x 3mm
- Integrated LC tank Balun to prevent influence of cable routing and cable length
- -1dBi Peak Gain @ 433MHz
- 48% high efficiency
- 300mm RG316 Coaxial Cable
- MMCX(M) Right Angle Connector
- Low profile – only 3mm in thickness

RoHS Compliant

Photo:

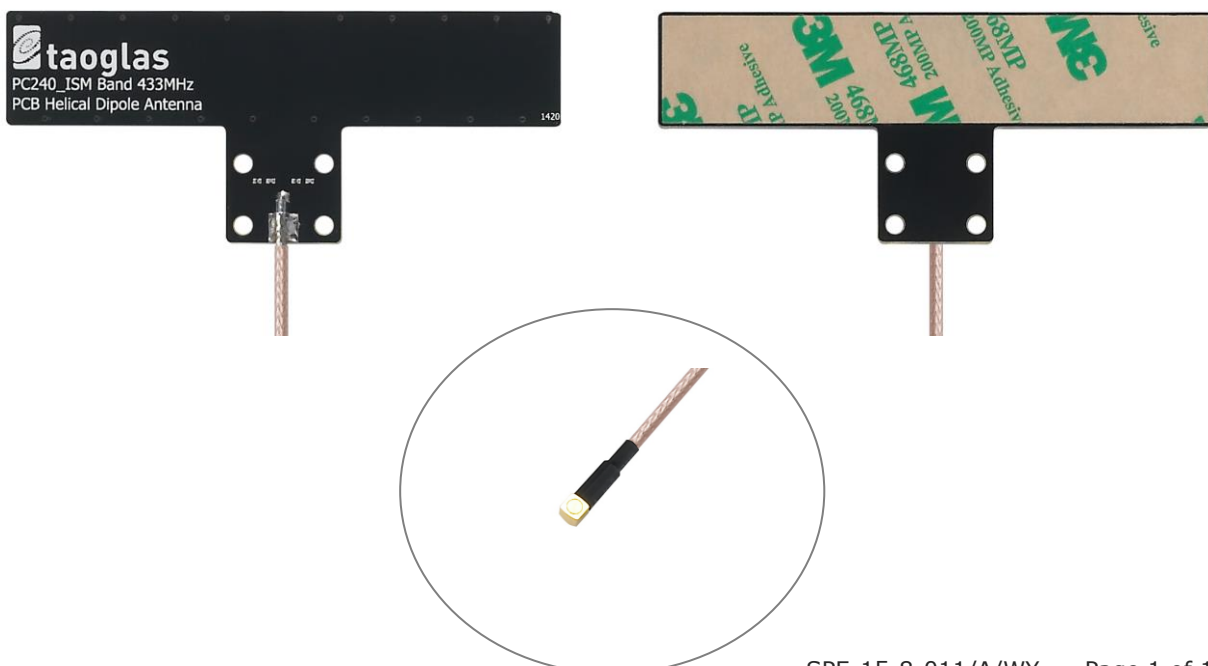

1. Introduction

The PC240.09.0300K is a 433MHz embedded omni-directional adhesive / screw mounted, linear polarised, dipole antenna with high efficiency at only 96mm in length.

The antenna was specifically designed for use in wireless alarm devices. It operates in license-free ISM band, making the PC240.09.0300K a suitable antenna in systems such as home security & alarm, home automation, metering, remote control, industrial control, and other 433MHz applications.

Most low frequency antennas detune inside enclosures when the cable is moved to new orientations. In order to mitigate the influence of cable routing direction while installing, the PC240.09.0300K uses a LC tank balun circuit. The LC tank balun circuit stabilizes the electrical characteristics when cable length changes. Please refer to Application Note (Section 7) for more details.

The PC240.09.0300K is designed as a helical dipole structure, which can significantly shorten the length while maintaining high efficiency. Users can easily attach the antenna on their device housing via the 3M adhesive, without worrying about their housing detuning the antenna as it has been tuned on a 2mm thick ABS board, which is typical enclosure thickness and material for electronic devices. It also has four thru holes that users can fix the antenna with screws.

With the balun circuit and helical dipole design, the PC240.09.0300K is truly a miniature 433 MHz PCB antenna, which can provide worry-free cable routing during installation.

2. Specification

| ELECTRICAL | | |
|------------------------------|-------------------|-------|
| Application Band | ISM | |
| Operation Frequency (MHz) | 433 | |
| Cable length (M) | 0.3 | |
| On 2mm thickness ABS Base | Average Gain (dB) | -3.14 |
| | Efficiency (%) | 48.82 |
| | Peak Gain | -0.97 |
| VSWR | < 2:1 | |
| Return Loss (dB) | < -10 | |
| Polarization | Linear | |
| Impedance | 50 Ohms | |

| MECHANICAL | |
|----------------|--|
| Dimension (mm) | Height = 3 mm, Length = 96 mm, Width = 40 mm |
| Cable length | 300mm RG316 – Fully Customizable |
| Connector | MMCX(M) RA – Fully Customizable |
| Material | Composite |
| Weight (g) | 18 |

| ENVIRONMENTAL RATINGS | |
|-----------------------|----------------------------|
| Temperature Range | -40°C to +85°C |
| Thermal Shock | 100 cycles -40°C to +85°C |
| Humidity | Non-condensing 65°C 95% RH |
| Cable Pulling Force | 18.2kgF |

3. Antenna Characteristics

3.1 Testing Setup

PC240 antenna was tested with R&S ZNB-8 network analyzer.

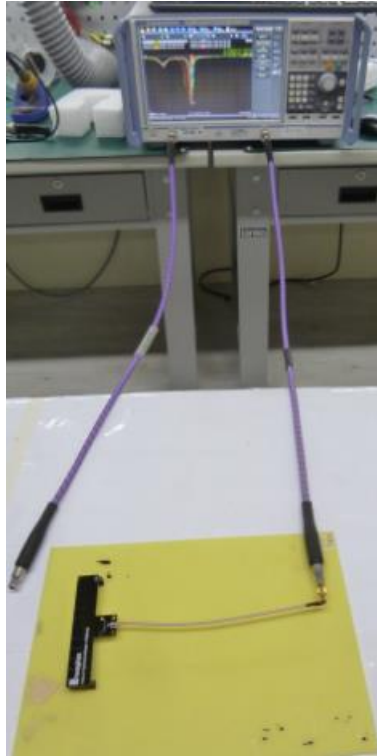

On 2mm thick ABS base

3.2 Return Loss

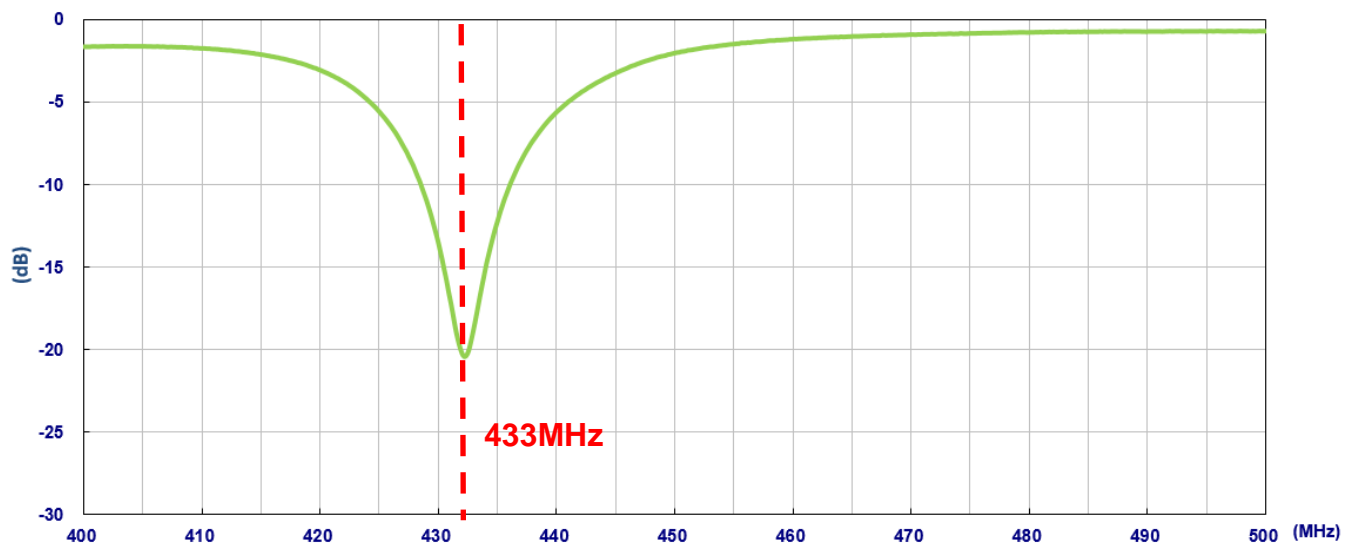

3.3 Average Gain

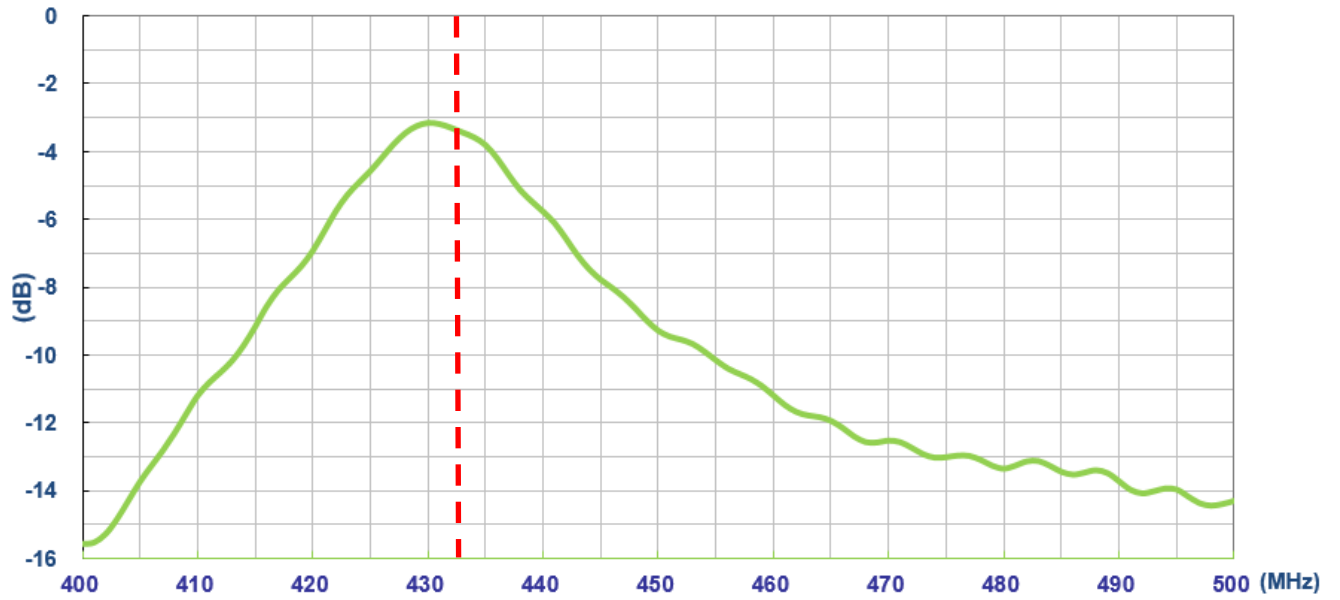

3.4 Efficiency

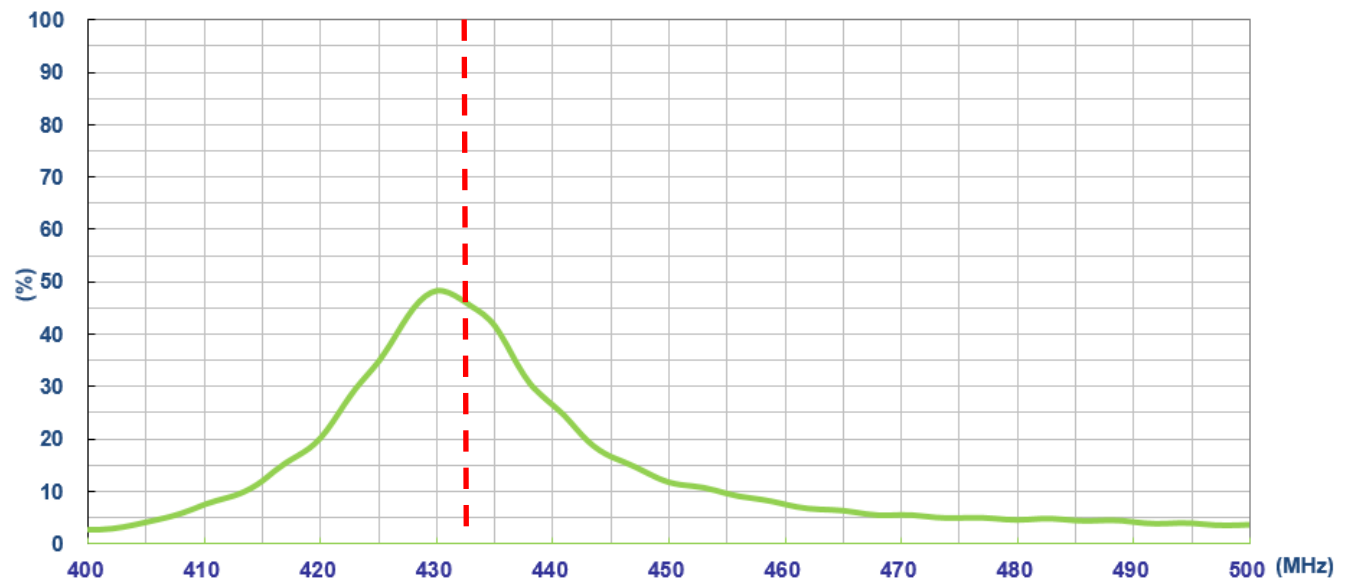

3.5 Peak Gain

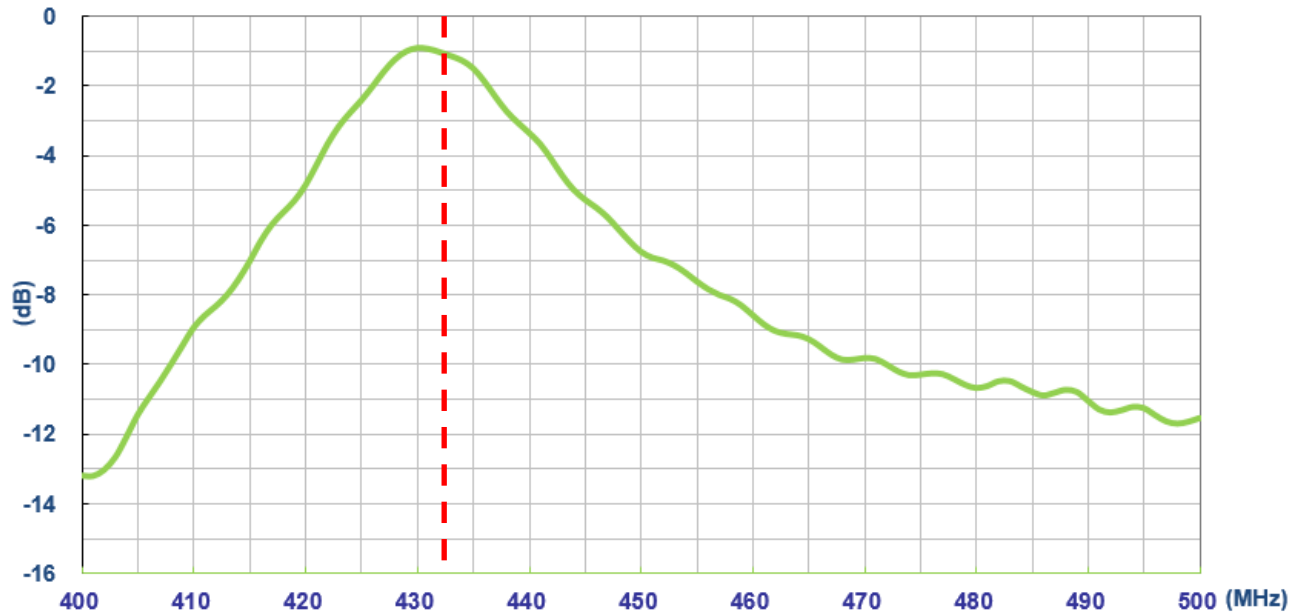

4. Antenna Radiation Patterns

4.1 Antenna Setup

The antenna radiation pattern measurement setup is shown below.

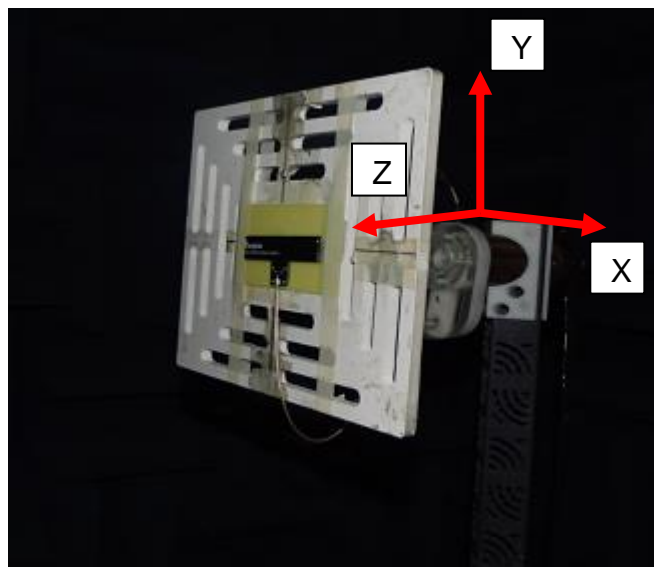

4.2 Antenna Radiation Patterns

2D Patterns

YZ Plane

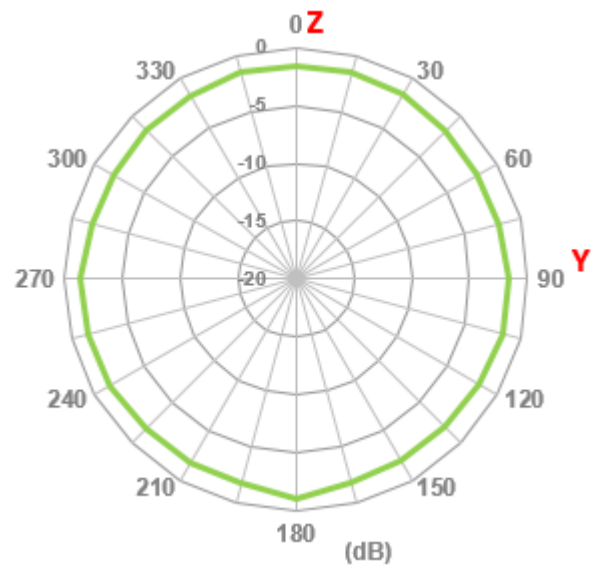

XY Plane

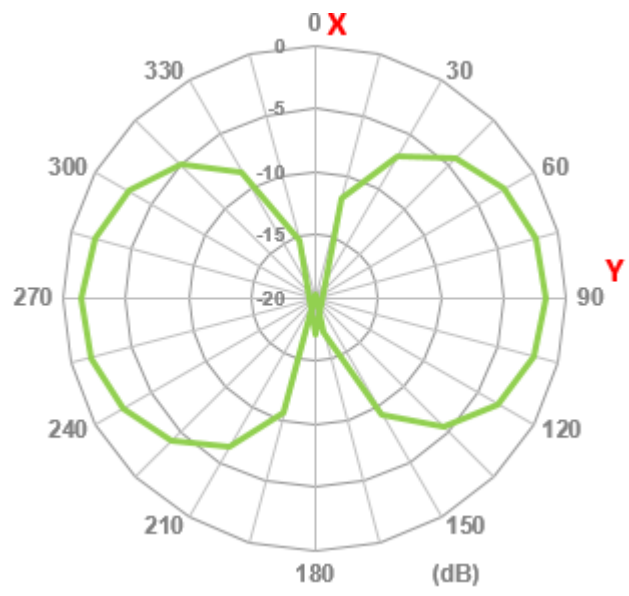

XZ Plane

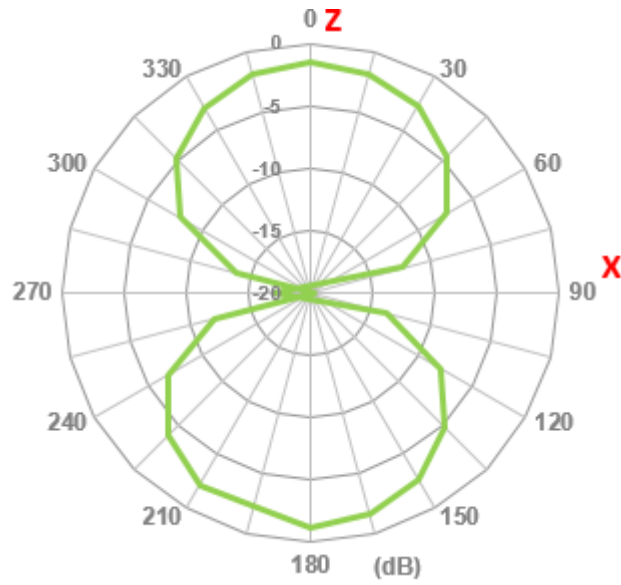

3D Patterns

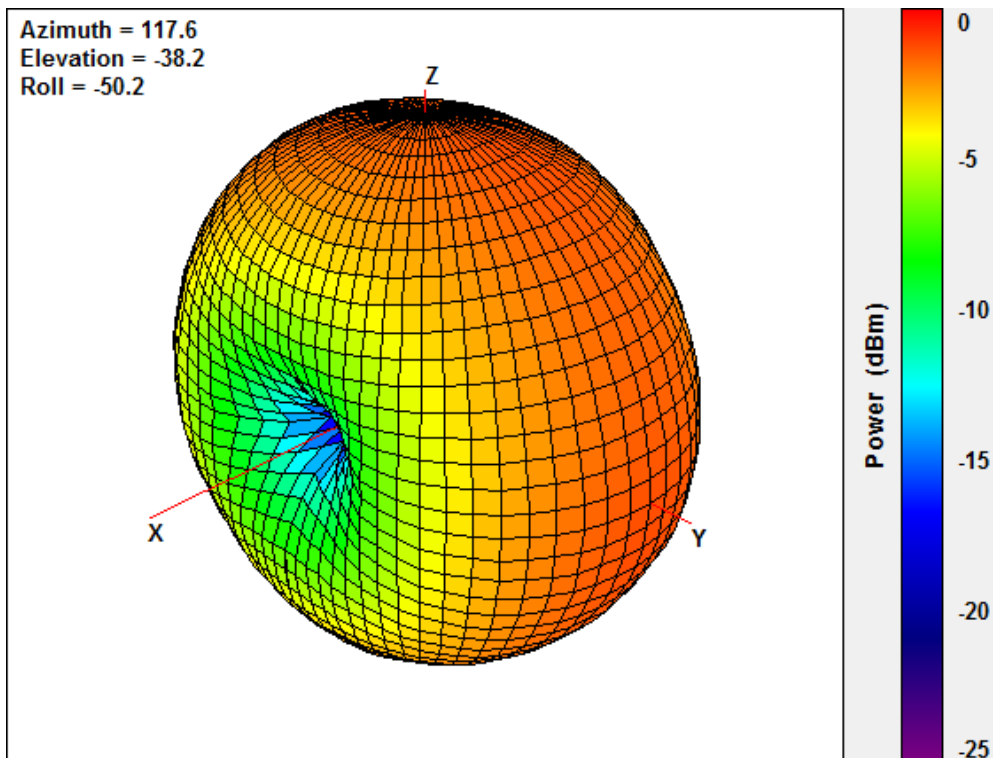

5. Drawing

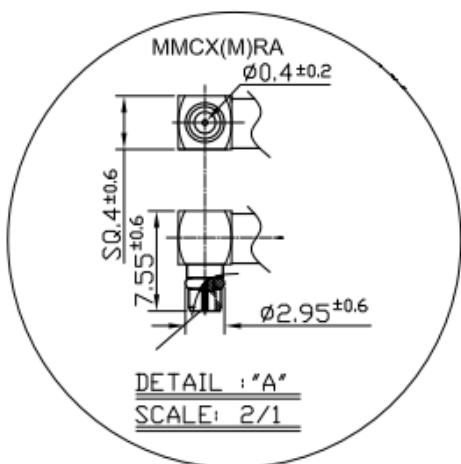
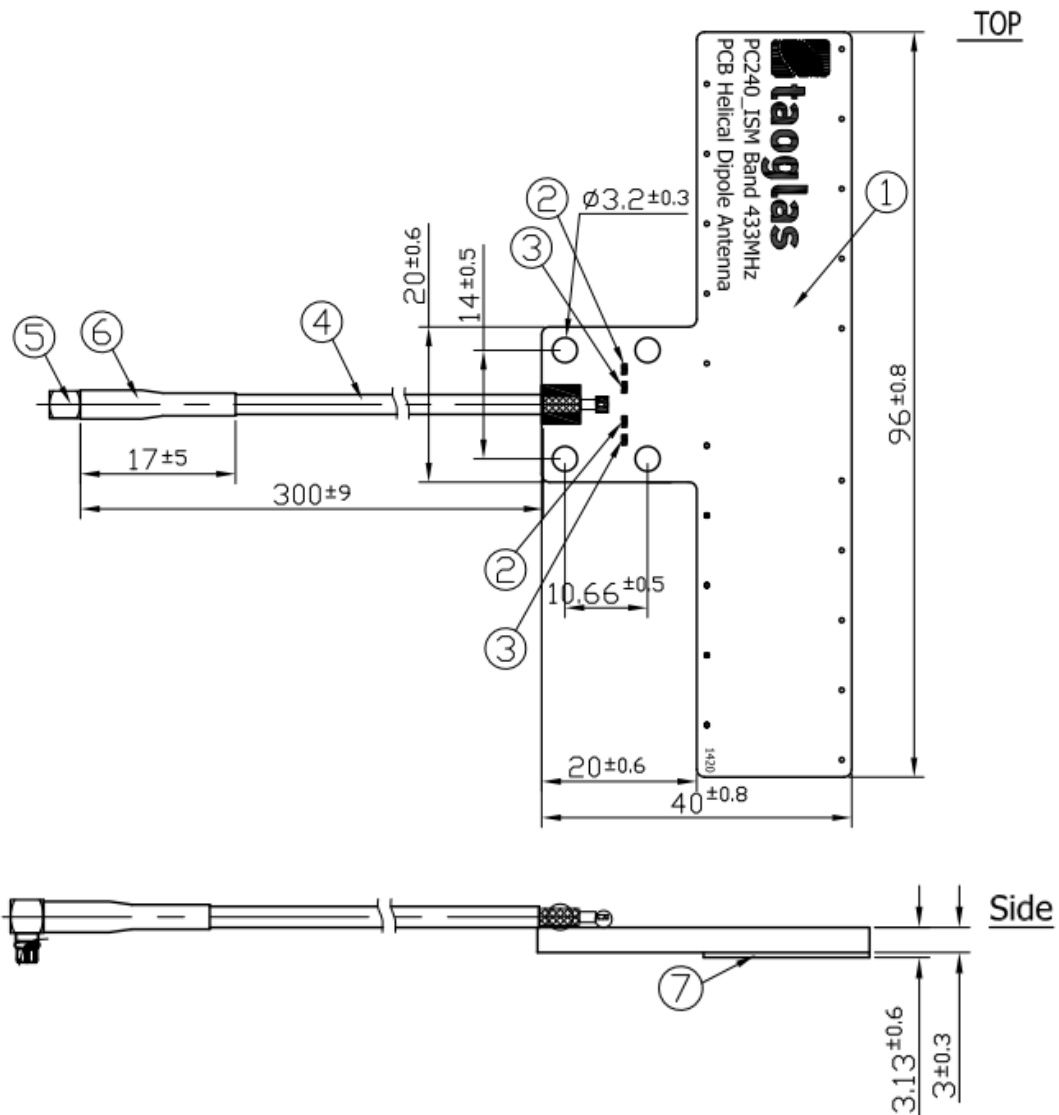

| | Name | P/N | Material | Finish | QTY |
|---|----------------------------|----------------|-----------|--------|-----|
| 1 | PC240 PCB (96x40x3t) | 100214G000011A | Composite | Black | 1 |
| 2 | Inductor | 001514I000090A | Ceramic | N/A | 2 |
| 3 | Capacitor | 001514I010090A | Ceramic | N/A | 2 |
| 4 | RG316 Coaxial Cable | 301613A000013A | FEP | Brown | 1 |
| 5 | MMCX(M)RA | 202711G000013A | Brass | Gold | 1 |
| 6 | Heat Shrink Tube | 001311F000013A | PE | Black | 1 |
| 7 | PC240 Adhesive 95x19x0.13t | 001014I000013A | 3M 468 | N/A | 1 |

6. Packaging (unit: mm)

1 Piece PC240.09.0300K per small PE bag
Dimensions - 140*130mm
Weight - 20g

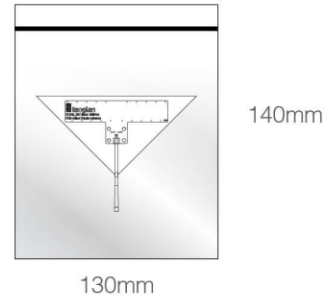

25 small PE bgs per large PE bag
Dimensions - 465*280mm
Weight - 0.50Kg

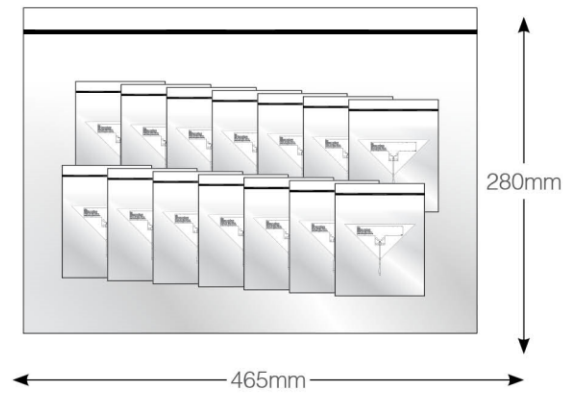

25 large PE bags per cartons
250 Pieces per carton
Carton Dimensions - 260*320*240
Weight - 12.5 Kg

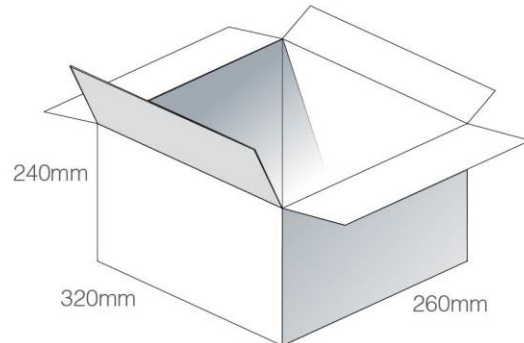

Pallet Dimensions 1100*1100*1330mm
60 Cartons per Pallet
12 Cartons per layer
5 Layers

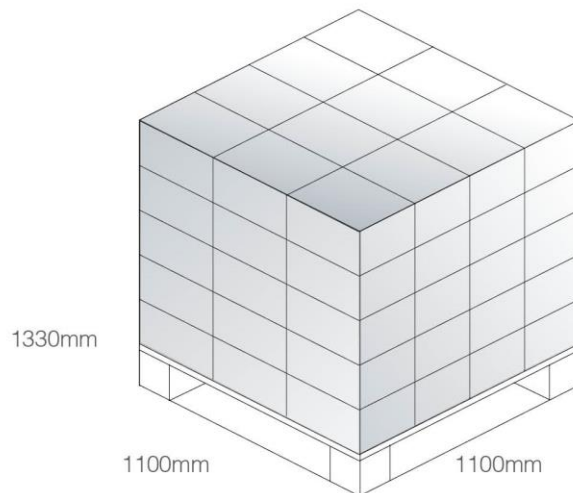

7. Application Note

7.1 PC240 antenna cable routing effects

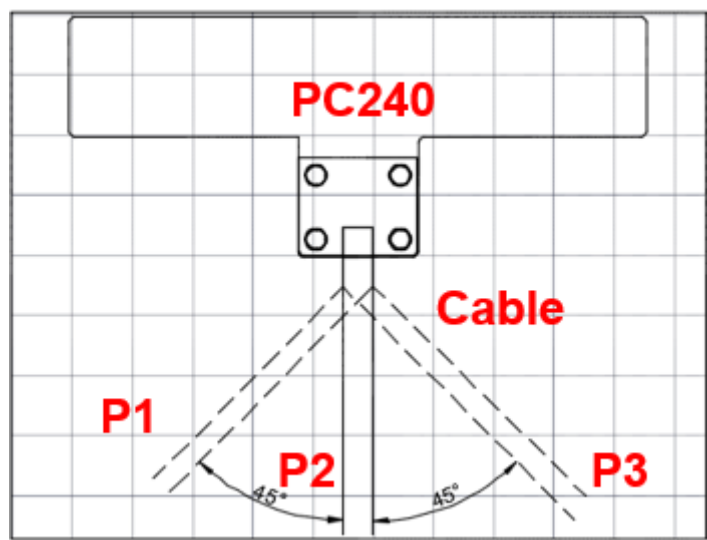
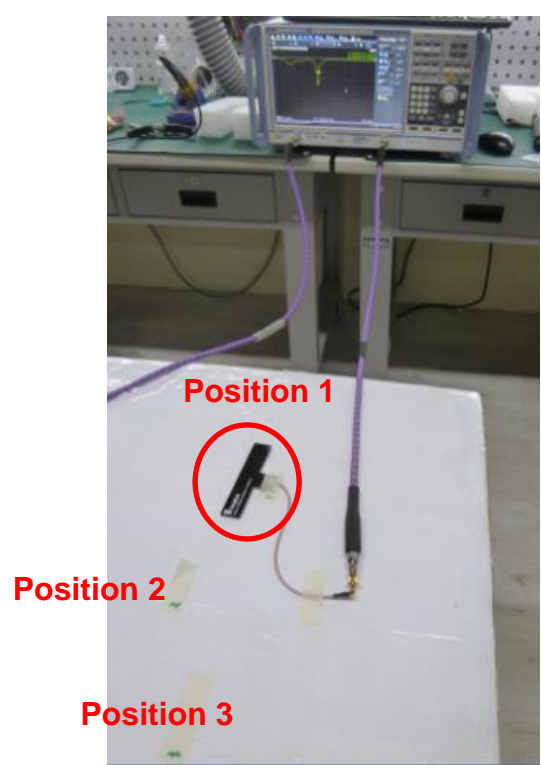

Cable Routing

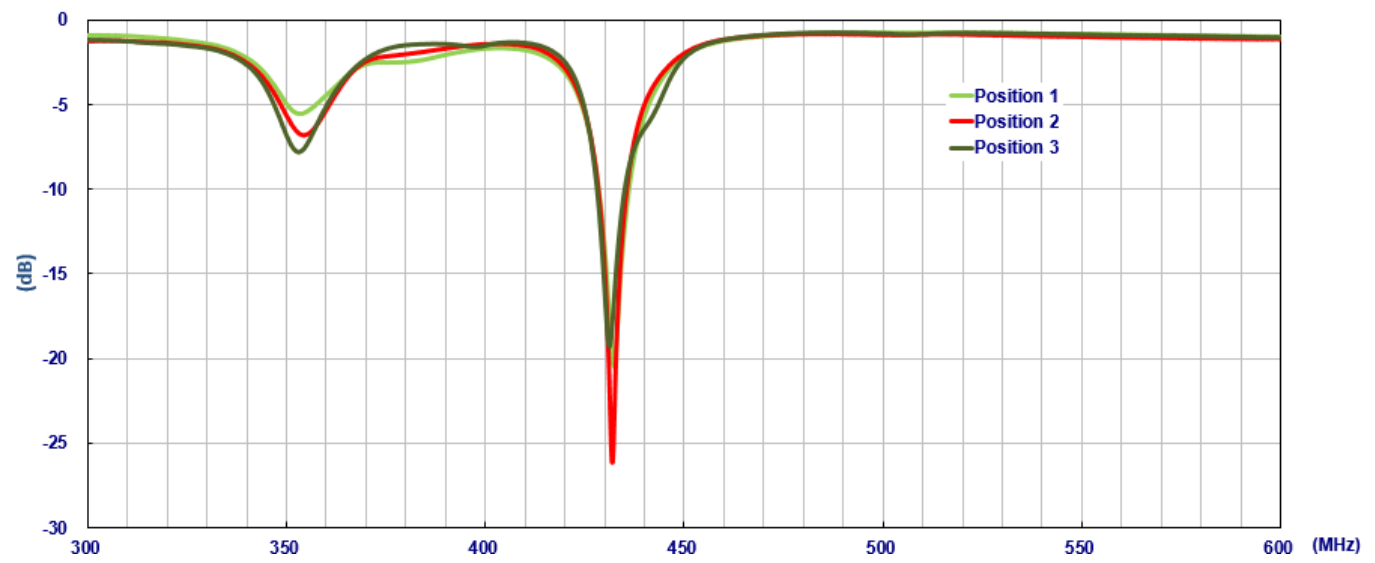

7.2 PC240 with long cable effects

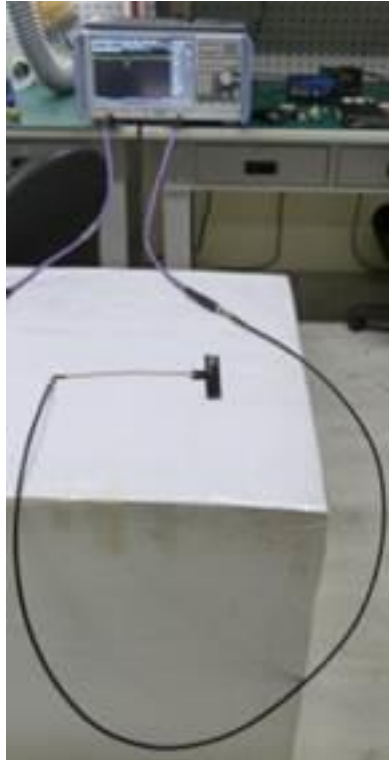

PC240 with extra 150cm cable

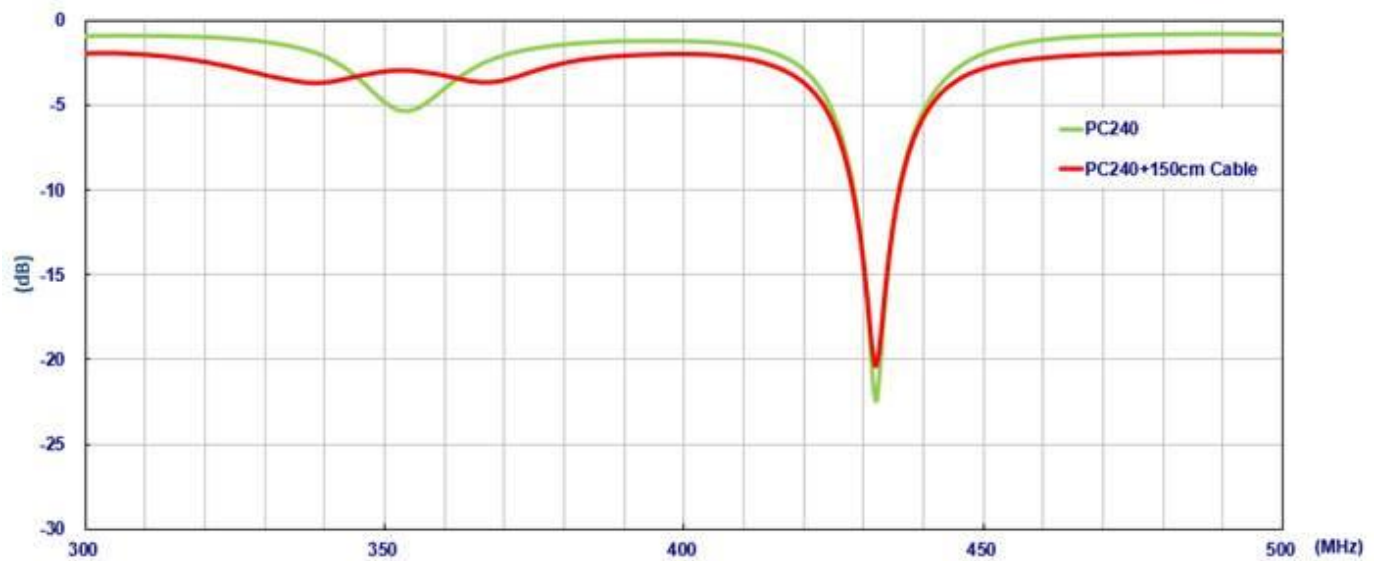

Through these two experiments, the LC tank Balun has isolated cable effects to antenna resonance.

8. Installation Recommendations

PC240 antenna is a resonant arm meandered non-standard dipole novel antenna design. However, it still keeps the same radiation characteristics as standard dipole antennas. It has an omni-directional radiation pattern in the H-Plane(2D YZ Plane in the spec). The installation recommendation of this antenna is mounting the antenna internally on the side walls of the device, with one of the arms of the T pointing downwards

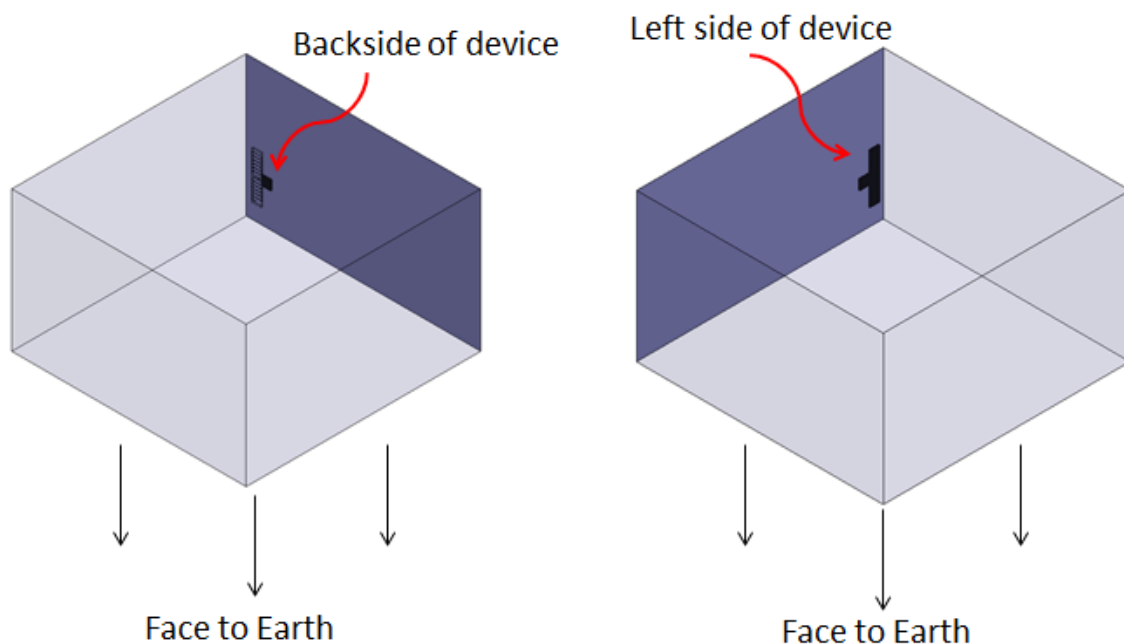

For either of the antenna installations shown above, the antenna will exhibit the radiation pattern as shown below.

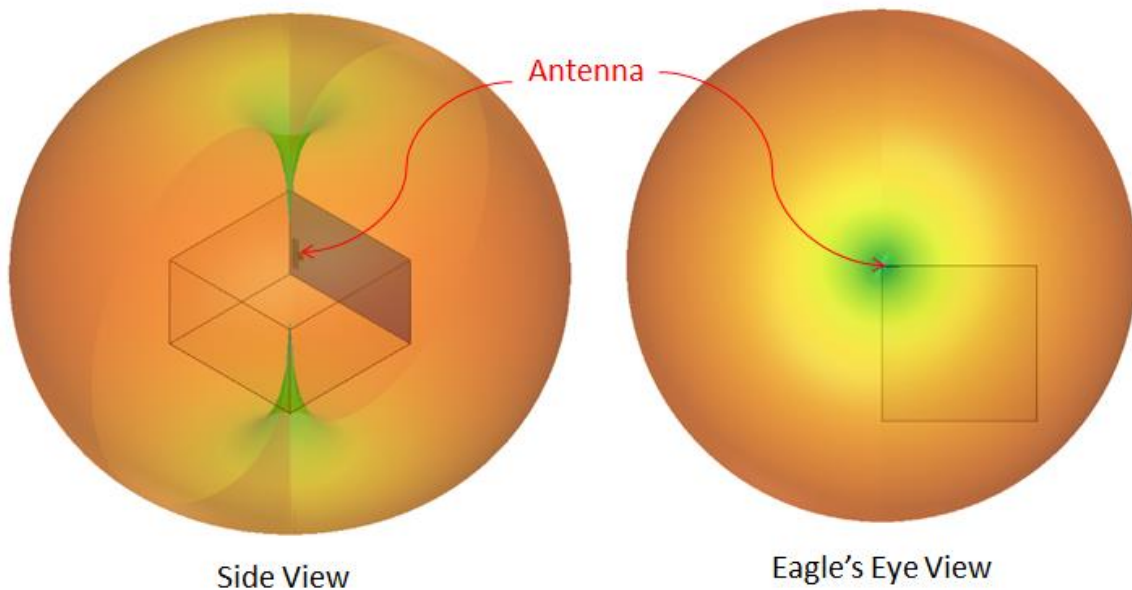

Orange means much higher antenna gains, Green means the weakest antenna gains. So the correct application of this antenna is to let the antenna edges as below face the sky and Earth. Then the antenna can have omni-directional radiation patterns that are horizontal to the Earth.

